

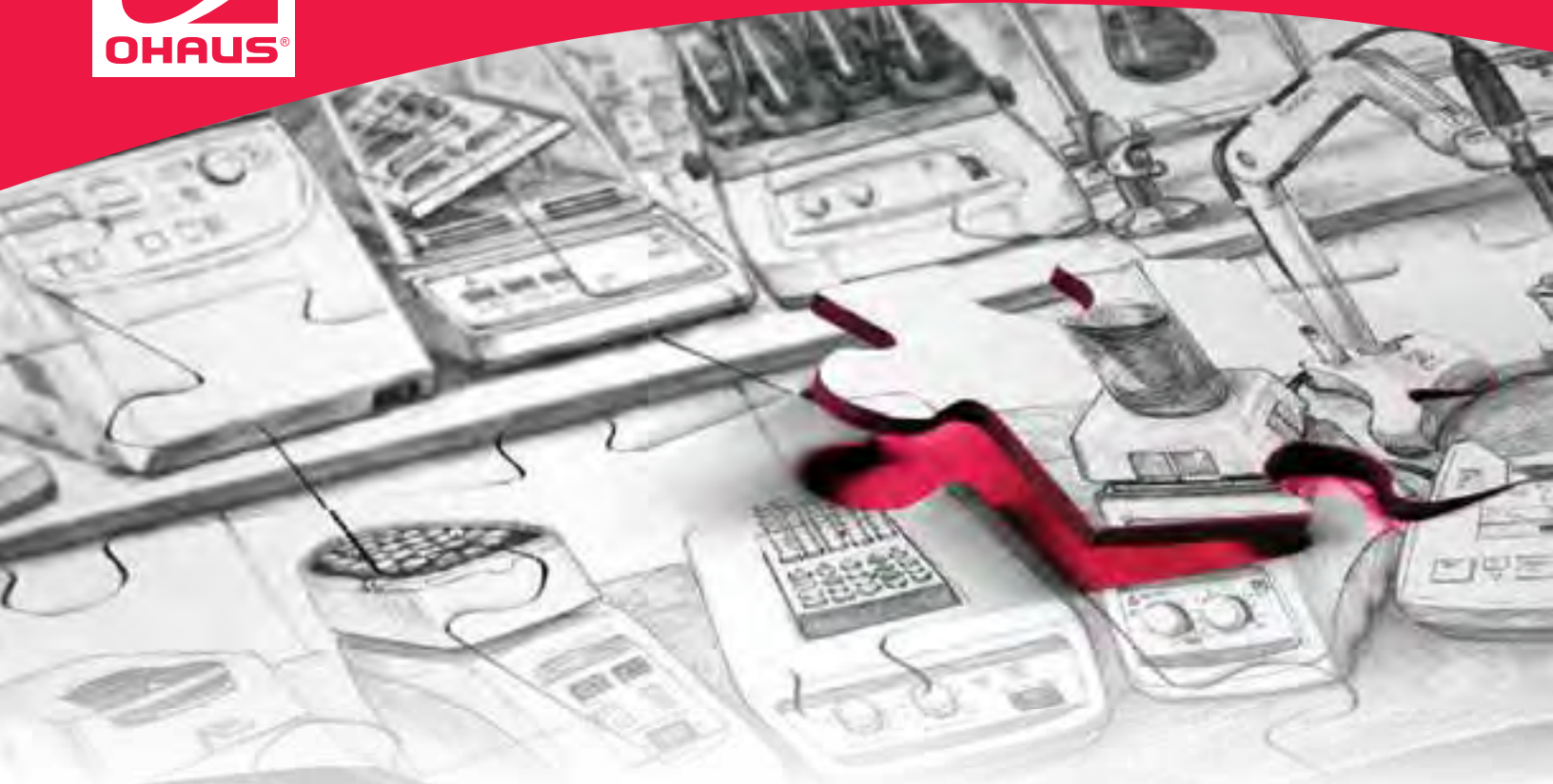

2018 Catalog



Do More With OHAUS

Look inside for NEW 2018 product and pricing information!

Ingeniously Practical

USD

Products at Work

The OHAUS product range is specifically designed to help maximize productivity, across every surface of the workspace. From the office to the warehouse, our Ingeniously Practical portfolio is packed with products made with your customers' needs in mind. Our industry-leading line of scales and balances offer the accuracy, speed, and peace of mind your customers need to Weigh It with ease, while our ever-growing line of laboratory instruments products allows them to Test It with the confidence they need. Introduced in 2017, the OHAUS line of laboratory equipment rounds out the ability to Do More in the lab, offering products ranging from mixers and shakers to clamps and supports – and everything in between.

*No matter what your customers' needs are, from research and development to fulfillment and receiving, you can depend on OHAUS for everything you need to let your customers' operations thrive. Don't stop at just measurement – **Do More.***

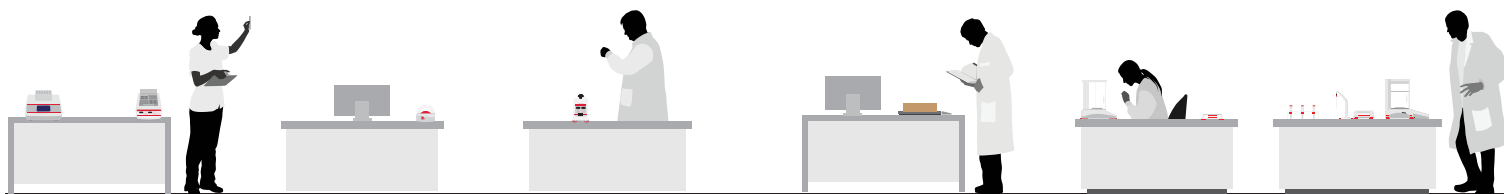

Office | Training Laboratory | R&D | Sample Preparation



Laboratory Equipment
Incubating Light Duty Shakers
Save incubator space with benchtop orbital shakers



Laboratory Equipment
Frontier™ 5000 Series Mutli Pro
Powerful and versatile universal centrifuges for virtually every lab application



Laboratory Balances
Adventurer®
Best in class performance laboratory balances



Laboratory Instruments
Starter 5000
Easy to use and intuitive benchtop pH meters

5,135

Product Offerings

265

Laboratory
Balances

238

Industrial
Balances

372

Laboratory
Equipment &
Instruments

2047

Calibration
Weights

2213

Accessories



Food Scales
Valor® 4000
Durable wash-down scales
with fast stability



Moisture Balances
MB120
Reliable and accurate moisture
analyzers



Bench Scales
Ranger® 3000
Bench scales built for
the toughest jobs

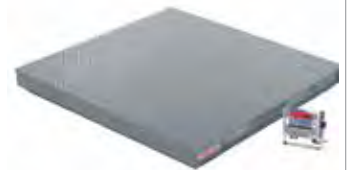

Floor Scales
VX Series
Economic floor scales for
daily industrial usage

Contents

Laboratory Weighing

Selection Guide..... 1

Analytical & Precision Balances

Explorer® Semi-Micro Balances 2
Explorer® Analytical 3
Explorer® Precision 4
Explorer® Precision High Capacity 6
Adventurer® Analytical 7
Adventurer® Precision 8
Pioneer® Analytical 10
Pioneer® Precision 11

Portable Balances

Scout® STX 12
Scout® SPX 13
Navigator® NV 14
Navigator® XT 15
Navigator® XL 16
CS Series 17
CL Series 18
HH Series 18
PS Series 19

Jewelry Scales

YA Gold Series 20

Moisture Analyzers

MB120 21
MB90 22
MB27 23
MB23 24

Mechanical Scales & Balances

D500M 25
Heavy Duty Solution 25
Field Test 26
Triple Beam Pro® 26
Triple Beam 700 Series 27
Triple Beam Junior 28
Triple Beam Dial-O-Gram® 1600 Series 28
Dial-O-Gram® and Cent-O-Gram® 300 Series 29
Harvard Junior 29
Harvard Trip® 30
School Balance 30
Primer® Balance 31
Spring Scales 32
Pull Type Spring Scales 32
Dial Type Spring Scales 32

Industrial Weighing

Selection Guide 34

Floor Scales

VX Series 35
VN Series 36
VN Series Floor Scale Platforms 36

Bench Scales

CKW Checkweigher 37
Defender® 7000 38
Defender® 7000 Low Profile 40
Defender® 5000 41
Defender® 5000 Low Profile 43
Defender® 3000 Washdown 44
Defender® 3000 45
ES Series 46
SD Series 47

Counting Scales

Ranger® 7000 48
Ranger® Count 4000 49
Ranger® Count 3000 50

Compact Bench Scales

Ranger® 7000 51
Ranger® 4000 52
Ranger® 3000 53
Valor® 7000 54
FD Series 55
Valor® 4000 56
Valor® 3000 57
Valor® 2000 58
Valor® 1000 59
Catapult® 1000 59

Indicators

CKW55 60
T72XW 61
T71XW 62
T71P 63
T51XW 64
T51P 65
T32XW 66
T32M 67
T31P 68

Bench Scale Bases

CKW Bases 69
Defender® W Series Stainless Steel 69
Defender® H Series Bases 70
Defender® Q Series Bases 70
Defender® V Series Stainless Steel 71
Defender® B Series Bases 71

Price Computing Scales

Aviator 7000 72

Calibration Weights

Overview 74
ASTM Weights & Weight Sets 75
OIML Weights & Weight Sets 84
NIST Weights & Weight Sets 89

Printer 92

Weighing Accessories 93

Laboratory Equipment

Centrifuges

Frontier™ Series 97
Frontier™ Series Rotors & Accessories 101

Open Air Shakers

Selection Guide 113
Light Duty Orbital Shakers 115
Extreme Environment Shakers 118
Heavy Duty Orbital Shakers 119
Rocking & Waving Shakers 125
Reciprocating Shakers 129

Incubating & Incubating Cooling Shakers

Selection Guide 130
Incubating Cooling Thermal Shakers .. 132
Incubating Light Duty Orbital Shakers 134
Incubating Cooling Orbital Shakers 136
Incubating Rocking & Waving Shakers 139
Open Air, Incubating, Incubating Cooling Shakers Accessories 141

Vortex Mixers

Mini Vortex Mixers 149
Heavy-Duty Vortex Mixers 153
Microplate Vortex Mixers 155
Multi-Tube Vortex Mixers 158

Dry Block Heaters

Dry Block Heaters 161
2 Block Dry Block Heaters with Lid 163

Hotplates & Stirrers

Mini Hotplates & Stirrers 167

Bead Mill Homogenizers

HT Lysing Bead Mill Homogenizers 168
Mini Lysing Bead Mill Homogenizers .. 168

LabJaws Clamps & Supports

Multi-Purpose Clamps 170
Specialty Clamps 175
Connectors & Holders 181
Rods, Frames, & Supports 184
Flow Control Clamps 196
Misc. Non-Electrical Products 197

Laboratory Instruments

Selection Guide 199

pH/ORP/Conductivity/ DO Measurement

Starter 5000 pH Bench 200
Starter 3100M Bench 201
Starter 3100 pH Bench 202
Starter 3100C Conductivity Bench 203
Starter 2100 pH Bench 204
Starter 300 pH Portable 205
Starter 300C Conductivity Portable ... 206
Starter 300D DO Portable 207
Starter 400D DO Portable 208
Starter Pen Meters 209
Starter Electrodes 210

Equipment & Instrument Accessories

211

Terms and Conditions of Sale 216

OHAUS MAP Policy 217

Dealer Resources 218

Dealer Support 219

Icon Legend 220

Laboratory Weighing



From our powerhouse flagship Explorer balance to our rugged and practical Pioneer, OHAUS has a wide variety of semi-micro, analytical, precision, high-capacity, and moisture balances that are ideal for use in almost every area of your laboratory – and beyond.



Laboratory Balance Selector Guide

	Analytical Balances				Precision Balances			Portables			Moisture Analyzers				
	Explorer Semi-Micro	Explorer	Adventurer	Pioneer	Explorer	Adventurer	Pioneer	Navigator	Scout	CS/CL	MB120	MB90	MB27	MB23	
Weighing Capacity Range	51 g - 220 g	120 g - 320 g	120 g - 320 g	80 g - 220 g	220 g - 35000 g	220 g - 8200 g	160 g - 4200 g	210 g - 20 kg	120 g - 8200 g	200 g - 5000 g	Weighing Capacity Range	120 g	90 g	90 g	110 g
Readability Range	0.01 mg	0.1 mg	0.1 mg	0.1 mg	0.001 g - 0.1 g	0.001 g - 0.1 g	0.001 g - 0.1 g	0.01 g - 1 g	0.001 g - 1 g	0.1 g - 1 g	Readability Range	0.001 g	0.001 g	0.001 g	0.01 g
Parts Counting	●	●	●	●	●	●	●	●	●	●	Halogen	●	●	●	
Percent Weighing	●	●	●	●	●	●	●	●	●	●	Infrared				●
Custom Unit -Factor Entry	●	●	●	●	●	●	●		●		Color Graphics Display	●	●		
Checkweighing	●	●	●		●	●		●	●		Backlit LCD			●	●
Dynamic Weighing	●	●	●	●	●	●	●		●		Touchscreen	●	●		
Gross/Net/Tare	●	●	●		●	●					% Moisture	●	●	●	●
Totalization	●	●	●		●	●		●	●		% Solids	●	●	●	●
Statistics	●	●	●		●	●					External Calibration	●	●	●	●
Differential Weighing	●	●			●						GLP / Time / Date	●	●		
Filling	●	●			●						RS232	●	●	●	●
Density Determination	●	●	●	●	●	●	●		●		Temperature Range	40-230 C°	40-200 C°	50-160 C°	50-160 C°
Pipette Calibration	●	●			●*						Page No.	21	22	23	24
High Point	●	●			●										
Display Hold			●			●		●	●						
Formulation	●	●	●		●	●									
Ingredient Costing		●			●										
Battery Power					●*			●	●	●					
Backlight LCD				●			●	●	●						
LCD				●			●	●	●	●					
Color Graphics Display	●	●	●		●	●			●*						
Touchscreen	●	●	●		●	●			●*						
Keys			●	●		●	●		●						
Multi Languages	●	●	●		●	●			●*						
RS232	●	●	●	●	●	●	●	○	○						
2nd RS232	○	○			○										
USB - Host	●	●	●		●	●			○						
USB - Device	●	●	●		●	●		○	○						
Ethernet	○	○			○			○	○						
GLP / Time / Date	●	●	●		●	●		○	●*						
Bluetooth									●						
Internal Calibration	●*	●*	●*	●*	●*	●*	●*		●*						
External Calibration	●	●	●	●	●	●	●	●	●	●					
AutoCal	●*	●*	●*		●*	●*									
Below Balance Weighing	●	●	●	●	●	●	●		●						
NTEP Certified or Measurement Canada Approved		●*	●*		●*	●*		●*							
Page No.	2	3	7	10	4-6	9	11	14-16	12-13	17-18					

○ Optional *on specific models

Explorer® Semi-Micro Balances

Built for Sophisticated, Professional Weighing

- Geared for high performance with up to 0.01 mg readability and capacities up to 220 g. The AutoCal™ Internal Calibration system ensures accuracy of results in applications that require high precision.
- Equipped with a color touchscreen display that enhances the user experience. In addition, touchless sensors, automatic draftshield doors (on select models) and ionizer ensure the integrity of results.
- SmarText™ 2.0 software, intuitive icon-based navigation, 99 item library, 10 user profiles and below minimum sample weight indication all combine to provide an easy yet efficient weighing experience.



- Application** Weighing, Percent Weighing, Parts Counting, Checkweighing, Dynamic/Animal Weighing, Filling, Totalization, Formulation, Differential Weighing, Density Determination, Peak Hold, Pipette Adjustment, SQC
- Display** Full-color VGA graphic display (5.7 in. diagonal), 4-wire resistive touchscreen. QWERTY keyboard and numeric keypad to quickly input GLP and GMP data and other application data
- Operation** AC Adapter (Included)
- Communication** Easy access communication ports including 2 units of USB port and RS232 and an optional third port of either RS232 or Ethernet. GLP/GMP Data Output with Real Time Clock. Data Transfer Function.
- Construction** Metal base, ABS top housing, stainless steel pan, anti-static glass draftshield with flip-top door, replaceable in-use cover, automatic door as option models



- Design Features** AutoCal™ fully automatic internal calibration system included on all models, fast stabilization time, four touchless sensors, built-in ionizer with automatic door models, 14 operating languages, save to USB function, menu lock switch, security bracket, integral weigh below hook for below balance weighing applications, removable stainless steel weighing platform, stability indicator, overload and underload indicators, auto standby.

Model	Auto Door	Capacity	Readability	Pan Size	Item No.	Price USD
EX125D		51 g; 120 g	0.01 mg; 0.1 mg	Ø 3.14 in / Ø 80 mm	30139510	5100
EX125		120 g	0.01 mg		30139511	6400
EX225D		120 g; 220 g	0.01 mg; 0.1 mg		30139512	6510
EX225D/AD	•				30139513	8100
EX225/AD	•	220 g	0.01 mg		30139514	8820

Accessories	Item No.	Price USD
Printer, Impact, SF40A, AM	30064203	798
Static Ionizer, ION-100A, AM	30130302	1403
USB Extension Cable, EX	30217067	83
Pipette Adjustment Kit, EX Semi-Micro	30252145	1168
Dust Cover, Balance with Draft Shield	30093334	39
Auxiliary Display, PAD7, PA AX EX	80251396	54
Paper Roll, (1), CBM910	80251932	15
Ink Ribbon, CBM910	80251933	44
Cable, RS232,CBM910-AV DV EX MB PA TxxP	80252571	155
Density Kit, Solids	80253384	624

Accessories	Item No.	Price USD
Cable, 25 Pin-9 Pin, PC-TxxP	80500524	155
Cable, RS232, IBM 9P, AV DV MB Ranger	80500525	155
Anti-Theft Device, MB AX EX	80850043	185
RS232 Kit, 2nd, EX EX-HiCap	83021081	155
Ethernet Kit, EX EX-HiCap	83021082	155
Cable, RS422, Extension, EX EX-HiCap	83021083	86
Cable, USB, Type A-B	83021085	155



Explorer® Analytical Intelligent Performance No Matter How Difficult the Task

- A large color touchscreen gives access to the advanced application modes and icon-driven application software features such as user manager, library, and minimum weight indication.
- Explorer features fast stabilization times, optimized linearity and repeatability specifications, enhanced vibration filtering as well as AutoCal™ calibration to ensure accuracy.
- The draftshield provides easy entry to the weighing chamber through the flip or sliding top door and the top-mounted side doors which can be automatically controlled on /AD models.



- Application** Weighing, Parts Counting, Percent Weighing, Checkweighing, Animal/Dynamic Weighing, Filling, Totalization/Statistics, Formulation, Differential Weighing, Density Determination, Peak Hold, Ingredient Costing, Pipette Adjustment, SQC
- Display** 5.7" (145 mm) Full-color VGA graphic touchscreen display with user-controlled brightness
- Operation** AC adapter (included)
- Communication** RS232 and USB (included) or second RS232/Ethernet (accessories sold separately). GLP/GMP data output with real-time clock.
- Construction** Modular design, metal base, ABS top housing, stainless steel pan, glass draftshield with top mounted side doors and flip/sliding top door, illuminated up-front level indicator, integral weigh below hook, security bracket, calibration lock, four touchless sensors, in-use cover
- Design Features** Selectable environmental filters, auto tare, user selectable span calibration points, software lockout and reset menu, user selectable communication settings and data print options, user definable project and user IDs, auto standby, 14 operating languages

Model	Auto Door	Capacity	Readability	Certified Readability	Pan Size	Item No.	Price USD
EX124		120 g	0.1 mg	—	Ø 3.5 in / Ø 90 mm	83021331	3767
EX124/AD	•					30061976	5274
EX224		220 g				83021332	4198
EX224/AD	•					30061977	5705
EX324		320 g				83021335	4951
EX324/AD	•		30061978	6350			

Approved Model	Auto Door	Capacity	Readability	Certified Readability	Pan Size	Item No.	Price USD
EX124N/AD	•	120 g	0.1 mg	1 mg	Ø 3.5 in / Ø 90 mm	30061997	5597
EX224N		220 g				83021334	4521
EX224N/AD	•					30061998	6027
EX324N		320 g				83021337	5274
EX324N/AD	•					30061999	6673

Accessories	Item No.	Price USD
Cable, RS9 M/F, 1.5 m	12122603	155
Printer, Impact, SF40A, AM	30064203	798
Cable, RS422, 9m, EX EX-HiCap	30078078	122
Dust Cover, Balance with Draft Shield	30093334	39
Auxiliary Display, PAD7, PA AX EX	80251396	54
Printer, Thermal, STP-103, US	80251992	622
Cable, RS232, CBM910-AV DV EX MB PA TxxP	80252571	155
Cable, ST103-AV DV EX MB PA TxxP	80252581	155
Density Kit, Solids	80253384	624
Cable, 25 Pin-9 Pin, PC-TxxP	80500524	155
Cable, RS232, IBM 9P, AV DV MB Ranger	80500525	155

Accessories	Item No.	Price USD
Adapter, 25 Pin-9 Pin, SF42 SRP275	80500572	54
Anti-Theft Device, SP PA AV NV	80850000	72
Anti-Theft Device, MB AX EX	80850043	185
Software, Winwedge	80850080	437
RS232 Kit, 2nd, EX EX-HiCap	83021081	155
Ethernet Kit, EX EX-HiCap	83021082	155
Cable, RS422, Extension, EX EX-HiCap	83021083	86
Cable, USB, Type A-B	83021085	155
Foot Switch Kit, EX EX-HiCap	83021086	147
In-Use-Cover, Terminal, EX	83033633	66

Explorer® Precision

Intelligent Performance No Matter How Difficult the Task

- A large color touchscreen gives access to the advanced application modes and icon-driven application software features such as user manager, library, and minimum weight indication.
- Explorer features fast stabilization times, optimized linearity and repeatability specifications, enhanced vibration filtering and the choice of traditional calibration or AutoCal™ models.
- Explorer's sturdy modular design includes metal housing and a display that can be separated from the weighing base and tower- or wall-mounted for easy viewing in any workspace.

Application Weighing, Parts Counting, Percent Weighing, Checkweighing, Animal/Dynamic Weighing, Filling, Totalization/Statistics, Formulation, Differential Weighing, Density Determination, Peak Hold, Ingredient Costing, Pipette Adjustment, SQC, Statistics

Display 5.7" (145 mm) Full-color VGA graphic touchscreen display with user-controlled brightness

Operation AC adapter (included)

Communication RS232 and USB (included) or second RS232/Ethernet (accessories sold separately). GLP/GMP data output with real-time clock.

Construction Modular design, metal base, ABS top housing, stainless steel pan, glass draftshield with top mounted side doors and flip/sliding top door (1 mg models only), illuminated up-front level indicator, integral weigh below hook, security bracket, calibration lock, four touchless sensors, in-use cover

Design Features Selectable environmental filters, auto tare, user selectable span calibration points, software lockout and reset menu, user selectable communication settings and data print options, user definable project and user IDs, auto standby, 14 operating languages



1 mg Model

Model	AutoCal™	Draft Shield	Capacity	Readability	Certified Readability	Pan Size	Item No.	Price USD
EX223/E		•	220 g	1 mg	—	Ø 5.1 in / Ø 130 mm	30061979	2045
EX223	•						83021341	2476
EX423/E							30061980	2583
EX423	•		83021342				2906	
EX623	•		620 g				83021348	3444
EX1103	•		1100 g				83021350	4090
EX2202/E		•	2200 g	0.01 g	—	7.5 in x 8 in / 190 mm x 200 mm	30061981	2261
EX2202	•						83021356	2691
EX4202/E							30061982	2637
EX4202	•		83021357				3067	
EX6202/E			30061983				3014	
EX6202	•		83021360				3444	
EX6201/E			6200 g	30061984	2476			
EX6201	•		0.1 g	83021361	2906			
EX10202	•		0.01 g	83021362	4090			
EX10201	•		10200 g	0.1 g	83021365	3122		

Explorer® Precision

Intelligent Performance No Matter How Difficult the Task

Approved Model	AutoCal™	Draft Shield	Capacity	Readability	Certified Readability	Pan Size	Item No.	Price USD
EX423N	•	•	420 g	1 mg	0.01 g	Ø 5.1 in / Ø 130 mm	83021344	3229
EX1103N	•		1100 g				83021352	4413
EX4202N	•	•	4200 g	0.01 g	0.1 g	7.5 in x 8 in / 190 mm x 200 mm	83021359	3390
EX10202N	•		10200 g				83021364	4413
EX10201N	•			83021367			3444	

Accessories	Item No.	Price USD
Cable, RS9 M/F, 1.5 m	12122603	155
Printer, Impact, SF40A, AM	30064203	798
Cable, RS422, 9m, EX EX-HiCap	30078078	122
USB Extension Cable, EX	30217067	83
Auxiliary Display, PAD7, PA AX EX	80251396	54
Printer, Thermal, STP-103, US	80251992	622
Cable, RS232, CBM910-AV DV EX MB PA TxxP	80252571	155
Cable, ST103-AV DV EX MB PA TxxP	80252581	155
Density Kit, Solids	80253384	624
Cable, 25 Pin-9 Pin, PC-TxxP	80500524	155
Cable, RS232, IBM 9P, AV DV MB Ranger	80500525	155

Accessories	Item No.	Price USD
Adapter, 25 Pin-9 Pin, SF42 SRP275	80500572	54
Anti-Theft Device, SP PA AV NV	80850000	72
Anti-Theft Device, MB AX EX	80850043	185
Software, Winwedge	80850080	437
RS232 Kit, 2nd, EX EX-HiCap	83021081	155
Ethernet Kit, EX EX-HiCap	83021082	155
Cable, RS422, Extension, EX EX-HiCap	83021083	86
Draft Shield Kit, EX	83021084	754
Cable, USB, Type A-B	83021085	155
Foot Switch Kit, EX EX-HiCap	83021086	147
Column Kit, EX	83021102	133
In-Use-Cover, Terminal, EX	83033633	66



Explorer® Precision High Capacity

Intelligent Performance No Matter How Difficult the Task

- A large color touchscreen gives access to the advanced application modes and icon-driven application software features such as user manager, library, and minimum weight indication.
- 2-D shock protection and IP54 base enclosure protect the balance from damage, while the AutoCal™ automatic internal calibration system ensures performance.
- Explorer's sturdy modular design features a color touch display that can be separated from the weighing base as well as two programmable touch-free sensors and a large weighing pan.



Application Weighing, Parts Counting, Percent Weighing, Checkweighing, Animal/Dynamic Weighing, Filling, Totalization/Statistics, Formulation, Differential Weighing, Density Determination, Peak Hold, Ingredient Costing, SQC, Statistics

Display 5.7" (145 mm) Full-color VGA graphic touchscreen display with user-controlled brightness

Operation AC Adapter (included) or rechargeable battery (accessory sold separately)

Communication RS232 and USB (included) or second RS232/Ethernet (accessories sold separately). GLP/GMP data output with real-time clock.

Construction Modular design, IP54 metal base, die-cast top housing, stainless steel pan, up-front level indicator, integral weigh below hook, calibration lock, two touchless sensors, terminal housing in-use cover

Design Features Selectable environmental filters, auto tare, user selectable span calibration points, software lockout and reset menu, user selectable communication settings and data print options, user definable project and user IDs, auto standby, 14 operating languages



Model	Capacity	Readability	Pan Size	Item No.	Price USD
EX12001	12000 g	0.1 g	14.8 in x 12.2 in 377 mm x 311 mm	30057099	3444
EX24001	24000 g			30057100	4198
EX35001	35000 g			30057101	4951

Accessories	Item No.	Price USD
Rechargeable Battery, EX-HiCap R71	30041295	311
Wheel Kit, Set(4), EX-HiCap	30041470	133
Printer, Impact, SF40A, AM	30064203	798
Cable, RS422, 9m, EX EX-HiCap	30078078	122
Column Kit, EX-HiCap	30078082	122
Auxiliary Display, PAD7, PA AX EX	80251396	54
Printer, Thermal, STP-103, US	80251992	622
Cable, ST103-AV DV EX MB PA TxxP	80252581	155
Cable, 25 Pin-9 Pin, PC-TxxP	80500524	155

Accessories	Item No.	Price USD
Cable, RS232, IBM 9P, AV DV MB Ranger	80500525	155
Anti-Theft Device, SP PA AV NV	80850000	72
Anti-Theft Device, MB AX EX	80850043	185
Software, Winwedge	80850080	437
RS232 Kit, 2nd, EX EX-HiCap	83021081	155
Ethernet Kit, EX EX-HiCap	83021082	155
Cable, RS422, Extension, EX EX-HiCap	83021083	86
Cable, USB, Type A-B	83021085	155
Foot Switch Kit, EX EX-HiCap	83021086	147
In-Use-Cover, Terminal, EX	83033633	66



Analytical & Precision Balances

Adventurer® Analytical

Ready For Your Lab, Wherever That May Be

- Fast stabilization and reliable operation are enhanced by the AutoCal™ option to ensure solid weighing performance and accurate, repeatable results for standard laboratory applications.
- The wide viewing angle color touchscreen provides access to all of Adventurer's applications, while dual USB ports with GLP/GMP tracking capabilities assist in the monitoring and reporting of data.
- The two piece, top-mounted draftshield doors reduce the footprint of the doors in the rear of the balance when open, and open wide on both sides in order to provide ample room to place samples.



Application Weighing, Parts Counting, Percent Weighing, Checkweighing, Animal/Dynamic Weighing, Totalization/Statistics, Formulation, Density Determination, Display Hold

Display 4.3" (109 mm) Full-color VGA graphic touchscreen with user-controlled brightness

Operation AC adapter (included)

Communication RS232, USB Host, USB Device (included). GLP/GMP data output with real-time clock.

Construction Metal base, ABS top housing, stainless steel pan, glass draftshield with two piece top mounted side doors and sliding top door, illuminated up-front level indicator, integral weigh below hook, security bracket, calibration lock, full housing in-use cover

Design Features Selectable environmental filters, auto tare, user selectable span calibration points, software lockout and reset menu, user selectable communication settings and data print options, user definable project and user IDs, 9 operating languages



Model	AutoCal™	Capacity	Readability	Certified Readability	Pan Size	Item No.	Price USD
AX124	•	120 g	0.1 mg	—	Ø 3.5 in / Ø 90 mm	30100600	3090
AX124/E						30100601	2757
AX224	•	220 g				30100602	3399
AX224/E						30100603	3053
AX324	•	320 g				30100604	3820

Approved Model	AutoCal™	Capacity	Readability	Certified Readability	Pan Size	Item No.	Price USD
AX224N	•	220 g	0.1 mg	1 mg	Ø 3.5 in / Ø 90 mm	30100630	3677

Accessories	Item No.	Price USD
Ink Ribbon, SF40A SF42A	12120798	44
Paper Roll, Set (2), 57.5mm, SF40A	12120799	14
Cable, RS9 M/F, 1.5 m	12122603	155
Printer, Impact, SF40A, AM	30064203	798
Dust Cover, Balance with Draft Shield	30093334	39
SP In-Use-Cover wo DS AX	30111777	23
SP In-Use-Cover DS AX	30111792	23
Auxiliary Display, PAD7, PA AX EX	80251396	54

Accessories	Item No.	Price USD
Paper Roll, (1), Thermal, STP103	80251931	16
Printer, Thermal, STP-103, US	80251992	622
Cable, ST103-AV DV EX MB PA TxxP	80252581	155
Density Kit, Solids	80253384	624
Cable, 25 Pin-9 Pin, PC-TxxP	80500524	155
Cable, RS232, IBM 9P, AV DV MB Ranger	80500525	155
Anti-Theft Device, MB AX EX	80850043	185
Cable, USB, Type A-B	83021085	155

Accumulation
 Checkweighing
 Density Determination
 Display Hold
 Dynamic Weighing
 Formulation
 Gross/Net/Tare
 Backlight
 Environmental Filters
 GLP Data Output
 GMP/GLP
 Internal Calibration
 Level Indicator
 Leveling Feet
 Multi-Language
 NTEP Certified

Parts Counting
 Percent Weighing
 Statistics
 Totalization
 Weighing
 Overload/Underload Indicators
 Security Bracket
 Software Lockout
 Stability Indicator
 Time/Date
 Touch Screen
 Weigh Below Hook
 Measurement Canada Approved

Adventurer® Precision

Ready For Your Lab, Wherever That May Be

- Fast stabilization and reliable operation are enhanced by the AutoCal™ option to ensure solid weighing performance and accurate, repeatable results for standard laboratory applications.
- The wide viewing angle color touchscreen provides access to all of Adventurer's applications, while dual USB ports with GLP/GMP tracking capabilities assist in the monitoring and reporting of data.
- The 1 mg models have a two piece, top-mounted draftshield with doors that open wide, providing ample room for sample placement, while the 0.01 g and 0.1 g models feature large weighing pans.

- Application** Weighing, Parts Counting, Percent Weighing, Checkweighing, Animal/Dynamic Weighing, Totalization/Statistics, Formulation, Density Determination, Display Hold
- Display** 4.3" (109 mm) Full-color VGA graphic touchscreen with user-controlled brightness
- Operation** AC adapter (included)
- Communication** RS232, USB Host, USB Device (included), GLP/GMP data output with real-time clock.
- Construction** Metal base, ABS top housing, stainless steel pan, glass draftshield with two piece top mounted side doors and sliding top door (1 mg models only), illuminated up-front level indicator, integral weigh below hook, security bracket, calibration lock, full housing in-use cover
- Design Features** Selectable environmental filters, auto tare, user selectable span calibration points, software lockout and reset menu, user selectable communication settings and data print options, user definable project and user IDs, 9 operating languages



Model	AutoCal™	Draft Shield	Capacity	Readability	Certified Readability	Pan Size	Item No.	Price USD	
AX223	•	•	220 g	1 mg	—	Ø 5.1 in / Ø 130 mm	30100605	1804	
AX223/E								30100606	1574
AX423	•							30100607	2122
AX423/E			420 g				30100608	1827	
AX523	•						30100609	2441	
AX523/E							30100610	2132	
AX622	•	•	620 g	0.01 g	—	7.7 in x 6.9 in / 195 mm x 175 mm	30122632	1486	
AX422/E			420 g				30127981	965	
AX822/E			820 g				30127983	1218	
AX1502	•		1520 g				30100611	1804	
AX1502/E							30100612	1523	
AX2202	•		2200 g				30100613	2016	
AX2202/E							30100614	1726	
AX4202	•		4200 g				30100615	2334	
AX4202/E							30100616	2030	
AX5202	•		5200 g				30100617	2547	
AX2201/E			2200 g				30248912	994	
AX4201	•		4200 g				30122634	1406	
AX4201/E							30122635	1150	
AX8201	•		8200 g				30100618	1569	
AX8201/E							30100619	1308	

Adventurer® Precision

Ready For Your Lab, Wherever That May Be

Approved Model	AutoCal™	Draft Shield	Capacity	Readability	Certified Readability	Pan Size	Item No.	Price USD
AX223N/E		•	220 g	1 mg	0.01 g	Ø 5.1 in / Ø 130 mm	30100631	1650
AX423N			420 g				30100632	2228
AX423N/E			520 g				30100633	1929
AX523N/E			620 g				30100634	2233
AX622N/E		•	620 g	0.01 g	0.1 g	7.7 in x 6.9 in / 195 mm x 175 mm	30100635	1279
AX1502N/E			1520 g				30100636	1599
AX2202N/E			2200 g				30100637	1827
AX4202N/E			4200 g				30122655	2132
AX8201N/E			8200 g				0.1 g	1 g

Accessories	Item No.	Price USD
Ink Ribbon, SF40A SF42A	12120798	44
Paper Roll, Set (2), 57.5mm, SF40A	12120799	14
Cable, RS9 M/F, 1.5 m	12122603	155
Printer, Impact, SF40A, AM	30064203	798
Dust Cover, Balance with Draft Shield	30093334	39
SP In-Use-Cover wo DS AX	30111777	23
SP In-Use-Cover DS AX	30111792	23
Auxiliary Display, PAD7, PA AX EX	80251396	54

Accessories	Item No.	Price USD
Paper Roll, (1), Thermal, STP103	80251931	16
Printer, Thermal, STP-103, US	80251992	622
Cable, ST103-AV DV EX MB PA TxxP	80252581	155
Density Kit, Solids	80253384	624
Cable, 25 Pin-9 Pin, PC-TxxP	80500524	155
Cable, RS232, IBM 9P, AV DV MB Ranger	80500525	155
Anti-Theft Device, MB AX EX	80850043	185
Cable, USB, Type A-B	83021085	155

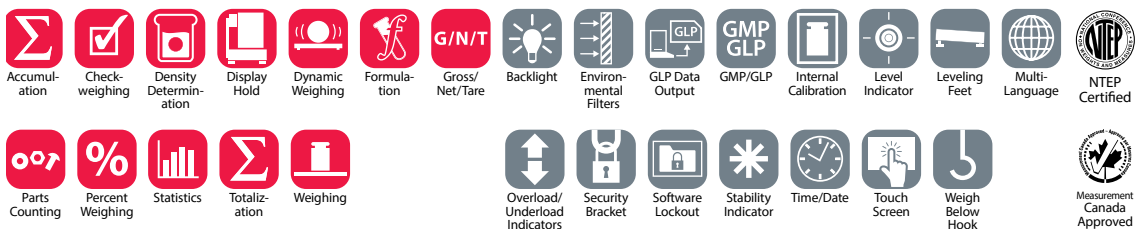

Pioneer[®] Analytical

The Economical Choice for Everyday Weighing

- Pioneer's draftshield is constructed of all glass panels and three sliding doors, which are easy to remove for cleaning or storage.
- The up-front level indicator is located right next to the display and allows the user to quickly make sure the balance is level prior to each use.
- Pioneer is designed with selectable environmental settings and three filter modes in order to ensure accurate operation in a variety of settings.



- Application** Weighing, Parts Counting, Percent Weighing
- Display** Liquid crystal display (LCD)
- Operation** AC adapter (included)
- Communication** RS232 (included)
- Construction** Metal base, ABS housing, stainless steel pan, glass draftshield with sliding top door, up-front level indicator, integrated weigh below hook, security bracket, calibration lock, full housing in-use cover
- Design Features** Selectable environmental filters, auto tare, software lockout and reset menu, user selectable communication and printing settings, auto standby



Model	InCal™	Capacity	Readability	Pan Size	Item No.	Price USD
PA84		85 g	0.1 mg	Ø 3.5 in / Ø 90 mm	30208440	1729
PA84C	•				30208454	1944
PA124		120 g			30208441	2075
PA124C	•				30208455	2290
PA224		220 g			30208442	2305
PA224C	•				30208456	2521

Accessories	Item No.	Price USD
Ink Ribbon, SF40A SF42A	12120798	44
Paper Roll, Set (2), 57.5mm, SF40A	12120799	14
Cable, RS9 M/F, 1.5 m	12122603	155
Printer, Impact, SF40A, AM	30064203	798
Dust Cover, Balance with Draft Shield	30093334	39
Auxiliary Display, PAD7, PA AX EX	80251396	54
Paper Roll, (1), Thermal, STP103	80251931	16
Printer, Thermal, STP-103, US	80251992	622
Cable, RS232,CBM910-AV DV EX MB PA TxxP	80252571	155
Cable, ST103-AV DV EX MB PA TxxP	80252581	155

Accessories	Item No.	Price USD
Density Kit, Solids	80253384	624
Cable, 25 Pin-9 Pin, PC-TxxP	80500524	155
Cable, RS232, IBM 9P, AV DV MB Ranger	80500525	155
Adapter, 25 Pin-9 Pin, SF42 SRP275	80500572	54
Anti-Theft Device, SP PA AV NV	80850000	72
Software, Winwedge	80850080	437
In-Use-Cover, PA	83020221	37



Analytical & Precision Balances

Pioneer® Precision

The Economical Choice for Everyday Weighing

- Pioneer's compact design and small footprint allows the balance to easily fit into small areas of laboratory benches without overcrowding the workspace.
- The up-front level indicator is located right next to the display and allows the user to quickly make sure the balance is level prior to each use.
- Pioneer is designed with selectable environmental settings and three filter modes in order to ensure accurate operation in a variety of settings.

Application Weighing, Parts Counting, Percent Weighing

Display Liquid crystal display (LCD)

Operation AC adapter (included)

Communication RS232 (included)

Construction Metal base, ABS top housing, stainless steel pan, glass draftshield with sliding top door (1 mg models only), up-front level indicator, integral weigh below hook, security bracket, calibration lock, full housing in-use cover

Design Features Selectable environmental filters, auto tare, software lockout and reset menu, user selectable communication and printing settings, auto standby



Model	InCal™	Draft Shield	Capacity	Readability	Pan Size	Item No.	Price USD
PA163		•	162 g	1 mg	Ø 4.7 in / Ø 120 mm	30208443	1037
PA163C	•					30208457	1253
PA323			320 g			30208444	1210
PA323C	•					30208458	1426
PA523			520 g			30208445	1442
PA523C	•					30208459	1657
PA1602		•	1620 g	0.01 g	Ø 7 in / Ø 180 mm	30208446	932
PA1602C	•					30208460	1148
PA2202			2200 g	0.1 g		30208447	1095
PA2202C	•					30208461	1310
PA2201			3200 g	0.01 g		30208450	905
PA2201C	•					30208464	1102
PA3202			4200 g	0.01 g		30208448	1327
PA3202C	•					30208462	1542
PA4202			0.1 g	0.1 g		30208449	1499
PA4202C	•					30208463	1714
PA4201						30208453	1062
PA4201C	•		30208465	1261			

Accessories	Item No.	Price USD
Ink Ribbon, SF40A SF42A	12120798	44
Paper Roll, Set (2), 57.5mm, SF40A	12120799	14
Cable, RS9 M/F, 1.5 m	12122603	155
Printer, Impact, SF40A, AM	30064203	798
Dust Cover, Balance with Draft Shield	30093334	39
Auxiliary Display, PAD7, PA AX EX	80251396	54
Paper Roll, (1), Thermal, STP103	80251931	16
Printer, Thermal, STP-103, US	80251992	622

Accessories	Item No.	Price USD
Cable, RS232, CBM910-AV DV EX MB PA TxxP	80252571	155
Cable, ST103-AV DV EX MB PA TxxP	80252581	155
Density Kit, Solids	80253384	624
Cable, 25 Pin-9 Pin, PC-TxxP	80500524	155
Cable, RS232, IBM 9P, AV DV MB Ranger	80500525	155
Adapter, 25 Pin-9 Pin, SF42 SRP275	80500572	54
Anti-Theft Device, SP PA AV NV	80850000	72
Software, Winwedge	80850080	437
In-Use-Cover, PA	83020221	37

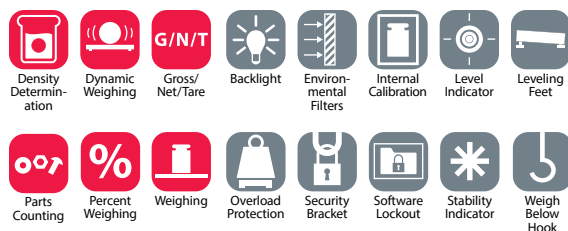

Scout® STX Touchscreen

Setting New Standards in Laboratory & Industrial Weighing - The Next Generation of Scout Balances

- Large, resilient color touchscreen allows for effortless operation of the Scout through its informative icon-driven menu structure, guiding the user through every step of the weighing application.
- Stabilization time as fast as 1 sec means increased productivity in your facility. Equipped with advanced weighing technology, the Scout also ensures repeatable and reliable weighing results.
- Integrated superior overload protection system rated at 10 times the capacity protects the balance in rugged and demanding environments. The space-saving, slim design allows for stackable storage.

Application Weighing, Parts Counting, Percent Weighing, Checkweighing, Animal/Dynamic Weighing, Totalization, Density Determination, Display Hold, Mole Weighing

Display 4.3" (109 mm) full-color VGA graphic touchscreen display with user-controlled brightness

Operation AC adapter (included) or 4 AA batteries (not included)

Communication RS232, USB Host, USB Device, Ethernet or Bluetooth® (available as accessories)

Construction ABS housing, stainless steel pan, ABS draftshield (1 mg models only), weigh below hook, transportation lock, manual calibration lock switch, security slot, adjustable leveling feet, illuminated up-front level indicator

Design Features Stability indicator, stackable design with included stacking and storage cover (excluding 1 mg models), mechanical and software overload/underload protection, low battery indicator, auto shut-off, auto tare, span calibration mass included on models up to 620 g capacity



Model	Capacity	Readability	Pan Size	Item No.	Price USD	
STX123	120 g	0.001 g	Ø 3.7 in / Ø 93 mm	30253005	681	
STX223	220 g			30253006	762	
STX222	220 g			30253007	499	
STX422	420 g	0.01 g	Ø 4.7 in / Ø 120 mm	30253008	699	
STX622	620 g			30253009	819	
STX1202	1200 g			5.5 in x 6.7 in / 140 mm x 170 mm	30253010	935
STX2202	2200 g				30253011	1051
STX421	420 g				30253012	282
STX621	620 g	0.1 g	Ø 4.7 in / Ø 120 mm	30253013	418	
STX2201	2200 g			30253014	528	
STX6201	6200 g			30253015	848	
STX8200	8200 g			1 g	30253016	438

Accessories	Item No.	Price USD
Printer, Impact, SF40A, AM	30064203	798
RS232 Kit, STX SPX ST3100M	30268982	133
USB Kit, Host, STX SPX	30268983	133
USB Kit, Device, STX SPX ST3100M	30268984	92
Bluetooth Kit, STX SPX	30268985	120
Ethernet Kit, STX SPX	30268986	144

Accessories	Item No.	Price USD
Stacking & Storage Cover, x6, STX SPX	30268987	51
Stacking & Storage Cover, x1, STX SPX	30268988	17
Auxiliary Display Kit, STX SPX	30269019	147
Density Kit, STX	30269020	16
Anti-Theft Device, MB AX EX STX SPX	80850043	185
Carrying Case, Scout	30269021	103



Scout® SPX

Setting New Standards in Laboratory & Industrial Weighing - The Next Generation of Scout Balances

- Combined with a simplified 4 button operation, the Scout's large backlit display increases readability in low light working conditions, and is easier to view from a distance.
- Integrated superior overload protection and impact-resistant pan support safeguard against shock and overloading the balance in rugged and demanding environments.
- Stabilization time as fast as 1 sec and advanced weighing technology lead to improved productivity in your facility. Increased capacity unlocks a wider range of weighing applications.

Application Weighing, Parts Counting, Percent Weighing, Checkweighing, Totalization, Display Hold

Display Liquid crystal display (LCD) with backlight

Operation AC adapter (included) or 4 AA batteries (not included)

Communication RS232, USB Host, USB Device, Ethernet or Bluetooth® (available as accessories)

Construction ABS housing, stainless steel pan, ABS draftshield (1 mg models only), weigh below hook, transportation lock, manual calibration lock switch, security slot, adjustable leveling feet, illuminated up-front level indicator

Design Features Stability indicator, stackable design with optional stacking & storage cover (excluding 1 mg models), mechanical and software overload/underload protection, low battery indicator, auto shut-off, auto tare, span calibration mass included on models up to 620 g capacity



Model	Capacity	Readability	Pan Size	Item No.	Price USD
SPX123	120 g	0.001 g	Ø 3.7 in / Ø 93 mm	30253017	608
SPX223	220 g			30253018	681
SPX222	220 g			30253019	446
SPX422	420 g	0.01 g	Ø 4.7 in / Ø 120 mm	30253020	625
SPX622	620 g			30253021	731
SPX1202	1200 g			30253022	835
SPX2202	2200 g	0.1 g	5.5 in x 6.7 in / 140 mm x 170 mm	30253023	939
SPX421	420 g			30253024	246
SPX621	620 g			30253025	364
SPX2201	2200 g	1 g	5.5 in x 6.7 in / 140 mm x 170 mm	30253026	459
SPX6201	6200 g			30253027	758
SPX8200	8200 g			30253028	381

Accessories	Item No.	Price USD
Printer, Impact, SF40A, AM	30064203	798
RS232 Kit, STX SPX ST3100M	30268982	133
USB Kit, Host, STX SPX	30268983	133
USB Kit, Device, STX SPX ST3100M	30268984	92
Bluetooth Kit, STX SPX	30268985	120
Ethernet Kit, STX SPX	30268986	144

Accessories	Item No.	Price USD
Stacking & Storage Cover, x6, STX SPX	30268987	51
Stacking & Storage Cover, x1, STX SPX	30268988	17
Auxiliary Display Kit, Scout STX, SPX	30269019	147
Density Kit, STX	30269020	16
Anti-Theft Device, MB AX EX STX SPX	80850043	185
Carrying Case, Scout	30269021	103

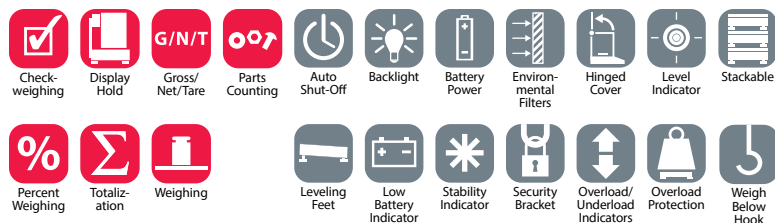

Navigator® NV

Multi-Purpose Balances with Touchless Sensors that Power Hands-Free Operation

- Operate the balance with the two touchless sensors that free up your hands for the handling of samples while limiting keypad wear and tear and cross-contamination.
- Navigator NV stabilizes in less than one second to provide fast and accurate weighing results while improving operator efficiency, productivity and throughput.
- The superior mechanical overload protection system safeguards the balance from sustaining damage when loads of up to 400% of its rated capacity are placed on the pan.



Application Weighing, Parts Counting, Percent Weighing, Checkweighing, Totalization, Display Hold

Display Backlit liquid crystal display (LCD)

Operation AC Adapter (Included) or 4 AA Batteries (Not included)

Communication RS232 or USB or Ethernet with integrated cable (accessories sold separately)

Construction ABS housing, stainless steel pan, illuminated up-front level indicator, auto shut off, shipping lock, security bracket, calibration lock, two touchless sensors

Design Features User selectable communication and printing settings, mechanical and software overload/underload protection

Model	Capacity	Readability	Pan Size	Item No.	Price USD
NV212	210 g	0.01 g	Ø 4.7 in / Ø 120 mm	83033081	360
NV211		0.1 g		30135291	204
NV511	510 g	0.1 g	5.4 in x 7.5 in / 138 mm x 190 mm	83033083	246
NV1101	1100 g	0.1 g		83033085	305
NV2101	2100 g	0.1 g		83033087	395
NV4101	4100 g	0.2 g		83033089	435
NV5101	5100 g	0.5 g		83033091	502
NV4000	4000 g	1 g		30135292	216

Accessories	Item No.	Price USD
Cable, PC, 9 Pin, NV AV	12106964	160
Auxiliary Display, TAD7, SP SPJ TA TAJ	80251395	54
Printer, Thermal, STP-103, US	80251992	622
Anti-Theft Device, SP PA AV NV	80850000	72
Software, Winwedge	80850080	437

Accessories	Item No.	Price USD
RS232 Kit, SP TA Navigator	83032107	133
USB Kit, SP TA NV NVL NVT	83032108	133
Ethernet Kit, NV NVL NVT	83032109	133
In-Use-Cover, NV	83032223	26
Carrying Case, NV	83032226	94



Navigator® XT

High-Capacity Balances with Touchless Sensors that Power Hands-Free Operation



- The legal-for-trade Navigator XT stabilizes in under a second and can accommodate samples up to 16 kg on its large weighing pan.
- Operate the balance with the two touchless sensors that free up your hands for the handling of samples while limiting keypad wear and tear.
- The mechanical overload protection system safeguards the balance from damage when loads of up to 400% of its rated capacity are placed on the pan.

Application Weighing, Parts Counting, Percent Weighing, Checkweighing, Totalization, Display Hold

Display Backlit liquid crystal display (LCD)

Operation AC Adapter (Included) or 4 AA Batteries (Not included), Rechargeable battery (Included)

Communication RS232 or USB or Ethernet with integrated cable (accessories sold separately)

Construction ABS housing, stainless steel pan, illuminated up-front level indicator, auto shut off, shipping lock, security bracket, calibration lock, two touchless sensors

Design Features User selectable communication and printing settings, mechanical and software overload/underload protection

Model	Capacity	Readability	Certified Readability	Pan Size	Item No.	Price USD
NVT1601/1	3.2 lb / 1600 g	0.0002 lb / 0.1 g	—	6.9 in x 9 in / 174 mm x 230 mm	83998182	486
NVT3201/1	6.4 lb / 3200 g	0.0005 lb / 0.2 g			83998186	486
NVT6401/1	16 lb / 6400 g	0.001 lb / 0.5 g			83998190	468
NVT10001/1	22 lb / 10000 g	0.002 lb / 0.5 g			83998194	486
NVT16000/1	32 lb / 16000 g	0.002 lb / 1 g			83998198	486

Approved Model	Capacity	Readability	Certified Readability	Pan Size	Item No.	Price USD
NVT1601N/1	3.2 lb / 1600 g	0.001 lb / 0.5 g	0.001 lb / 0.5 g	6.9 in x 9 in / 174 mm x 230 mm	83034112	510
NVT3200N/1	6.4 lb / 3200 g	0.002 lb / 1 g	0.002 lb / 1 g		83034116	510
NVT6400N/1	16 lb / 6400 g	0.005 lb / 2 g	0.005 lb / 2 g		83034120	492
NVT16000N/1	32 lb / 16000 g	0.01 lb / 5 g	0.01 lb / 5 g		83034124	510

Accessories	Item No.	Price USD
Cable, PC, 9 Pin, NV AV	12106964	160
Auxiliary Display, TAD7, SP SPJ TA TAJ	80251395	54
Printer, Thermal, STP-103, US	80251992	622
Anti-Theft Device, SP PA AV NV	80850000	72
Software, Winwedge	80850080	437
Rechargeable Battery, NVL NVT	83032106	45

Accessories	Item No.	Price USD
RS232 Kit, SP TA Navigator	83032107	133
USB Kit, SP TA NV NVL NVT	83032108	133
Ethernet Kit, NV NVL NVT	83032109	133
In-Use-Cover, NVT	83032221	26
Carrying Case, NVT	83032224	94

Navigator® XL

High-Capacity Balances with Touchless Sensors that Power Hands-Free Operation



- With less than a one second stabilization time, Navigator XL generates exceedingly accurate results quickly for applications requiring capacities up to 20 kg.
- Operate the balance with the two touchless sensors that free up your hands for the handling of samples while limiting keypad wear and tear.
- The superior mechanical overload protection system safeguards the balance from sustaining damage when loads of up to 400% of its rated capacity are placed on the pan.

Application Weighing, Parts Counting, Percent Weighing, Checkweighing, Totalization, Display Hold

Display Backlit liquid crystal display (LCD)

Operation AC Adapter (Included) or 4 AA Batteries (Not included) , Rechargeable battery (Included)

Communication RS232 or USB or Ethernet with integrated cable (accessories sold separately)

Construction ABS housing, stainless steel pan, illuminated up-front level indicator, auto shut off, shipping lock, security bracket, calibration lock, two touchless sensors

Design Features User selectable communication and printing settings, mechanical and software overload/underload protection

Model	Capacity	Readability	Pan Size	Item No.	Price USD
NVL511/1	510 g	0.1 g	7.6 in x 8 in / 194 mm x 203 mm	83033058	552
NVL1101/1	1100 g			83033062	602
NVL2101/1	2100 g			83033066	653
NVL5101/1	5100 g	0.5 g		83033070	629
NVL10000/1	10000 g	1 g		83033074	703
NVL20000/1	20000 g			83033078	703

Accessories	Item No.	Price USD
Cable, PC, 9 Pin, NV AV	12106964	160
Auxiliary Display, TAD7, SP SPJ TA TAJ	80251395	54
Printer, Thermal, STP-103, US	80251992	622
Anti-Theft Device, SP PA AV NV	80850000	72
Software, Winwedge	80850080	437
Rechargeable Battery, NVL NVT	83032106	45

Accessories	Item No.	Price USD
RS232 Kit, SP TA Navigator	83032107	133
USB Kit, SP TA NV NVL NVT	83032108	133
Ethernet Kit, NV NVL NVT	83032109	133
In-Use-Cover, NVL	83032222	26
Carrying Case, NVL	83032225	94

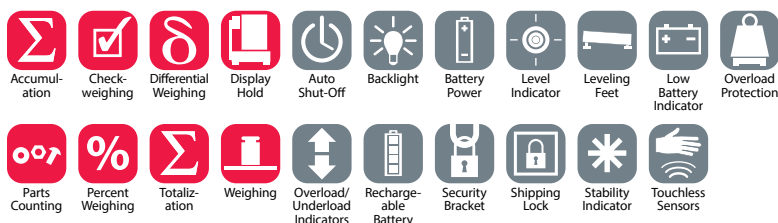

CS Series

When Cost Matters But Dependable Results Are A Must

- The large weighing platform can accommodate larger samples and can also be removed for easy cleaning.
- Radio frequency protection allows the CS to deliver stable results even when used in areas in which radio waves may be emitted.
- The low profile CS is battery operated or can be powered by a standard AC adapter.



- Application** Weighing
- Display** Liquid crystal display (LCD)
- Operation** AC adapter (included) or 3 AA batteries(included)
- Construction** ABS Housing, Stainless Steel Pan
- Design Features** Mechanical and software overload / underload protection, auto shut-off

Model	Capacity	Readability	Pan Size	Item No.	Price USD
CS200	200 g	0.1 g	5.75 in x 5.25 in / 145 mm x 133 mm	72212663	140
CS2000	2000 g	1 g		72212664	140
CS5000	5000 g			72212665	165

Model	Capacity	Readability	Pan Size	Item No.	Price USD
CS200P	200 g	0.1 g	5.75 in x 5.25 in / 145 mm x 133 mm	80500633	150
CS2000P	2000 g	1 g		80500634	150
CS5000P	5000 g			80500635	179

"P" models include Postal Chart

Accessories	Item No.	Price USD
Carrying Case, CS	80010624	51
Bowl, 1050ml, CS	80850075	42
Pan Cover, SST, CS	80850076	47

Accessories	Item No.	Price USD
PWR,ACCES,AC-PRONG	46001776	14
PWR,W,IN,6W,12VDC,S21x55x9x100,S	46001724	37



CL Series

Reliable, Easy-to-Use Balance for Basic Weighing

- The low profile CL has a stackable design which allows the balance to be stored securely and orderly.
- The integrated load cell lock protects the weighing cell from damage during transportation and while in storage.
- The CL is battery operated and automatically shuts off after a certain period of non-use to preserve battery life.

Application Weighing

Display Liquid crystal display (LCD)

Operation 3 AA batteries (included) or AC adapter (accessory sold separately)

Construction ABS housing and pan

Design Features Mechanical and software overload/underload protection, auto shut-off

Model	Capacity	Readability	Pan Size	Item No.	Price USD
CL201	200 g	0.1 g	Ø 4.75 in / Ø 120 mm	80010610	96
CL2000	2000 g	1 g		80010611	96
CL5000	5000 g			80010612	132
CL5000F				80010621	190

"F" model includes carrying case

Accessories	Item No.	Price USD
PWR,ACCES,AC-PRONG	46001776	14
PWR,W,IN,6W,12VDC,S21x55x9x100,S	46001724	37
Pan Cover, SST, CL	80010623	14



CL5000F



HH Series

Convenient, Compact and Portable Weighing in a Functional Design

- HH is available in capacities ranging from 120 g to 320 g and is ideal for a variety of general, on-the-go weighing applications for many industries.
- A backlit display illuminates the screen for viewing in dim lighting conditions, and a power-saving automatic shut-off feature conserves battery life.
- Among HH's protective features are durable ABS housing and a snap-on cover for protection during storage and transportation.

Application Weighing

Display Liquid crystal display (LCD)

Operation 2 AAA batteries (included)

Construction ABS housing and pan, protective snap-on cover

Design Features Overload/underload indicators, external push-button calibration

Model	Capacity	Readability	Pan Size	Item No.	Price USD
HH120	120 g	0.1 g	3.25 in x 3 in / 83 mm x 76 mm	71142842	189
HH120D	60 g / 120 g	0.2 g		71142841	158
HH320	320 g	0.1 g		71142844	235



PS Series

High Performance Portable Weighing in the Palm Of Your Hand

- The one-piece combination pan and cover slides back when being used to weigh and forward when not in use to protect the buttons and display during storage and transportation.
- One of the smallest portable balances on the market, PS can easily fit into a standard shirt pocket.
- The “pop-out” design of the battery compartment provides simple and fast battery replacement.



- Application** Weighing
- Display** Liquid crystal display (LCD)
- Operation** 2 lithium batteries (included)
- Construction** ABS housing and protective sliding pan
- Design Features** Software overload/underload indicators, auto shut-off

Model	Capacity	Readability	Pan Size	Item No.	Price USD
PS121	120 g	0.1 g	2.5 in x 2.5 in / 64 mm x 64 mm	80104060	59
PS251	250 g			80104061	77



YA Gold Series

Portable Precision Weighing in a Compact Case

- A hinged cover, sturdy plastic housing and stainless steel weighing pan protect the small balance from damage.
- With an extremely fast stabilization time, your results will appear quickly on the blue backlit LCD display.
- Powered by two 'AAA' batteries, a power-saving auto shut-off feature helps to conserve battery life.



- Application** Weighing
- Display** Backlit liquid crystal display (LCD)
- Operation** 2 AAA batteries (included)
- Construction** ABS housing, stainless steel pan, protective cover
- Design Features** Mechanical and software overload indicator, auto shut-off



Model	Capacity	Readability	Pan Size	Item No.	Price USD
YA102	100 g	0.01 g	2.8 in x 2 in / 70 mm x 50 mm	80251910	95
YA302	300 g	0.05 g		80251911	81
YA501	500 g	0.1 g		80251912	58



Moisture Analyzers

MB120

Moisture Analysis Made Simple and Powerful



- MB120's Temperature Guide analyzes a sample and determines the optimal drying temperature. Store up to 100 drying methods for easy recall and up to 1000 total results for statistical analysis.
- Precisely controlled halogen heating dries samples uniformly, producing repeatable results of 0.01% readability. Four drying profiles and predefined and user definable shut-off criteria help to perform customized sample tests.
- The MB120 features a removable pan handler and sample chamber for easy cleaning. Operating the MB120 is intuitive – simply follow the guided instructions on the touchscreen display.

Application Percent Moisture Determination, Percent Moisture Regain Determination, Percent Solid Determination, Weighing

Display 4.3" TFT color touchscreen display

Operation Power cord (included)

Communication RS232, USB Host and USB Device (included)

Construction Metal base, ABS top housing, halogen heat source, stainless steel pan support, stainless steel pan handler, in-use cover

Design Features Seven shut-off criteria (manual, timed, autofree %/s, autofree mg/s, A30, A60 and A90), four drying profiles (standard, fast, ramp and step), storage for up to 100 methods and 1000 test results for all methods, temperature guide, 40°C to 230°C heating temperature range (1°C increments), 13 operational languages

Model	Capacity	Readability	Moisture Readability	Pan Size	Item No.	Price USD
MB120	120 g	1 mg	0.01 %	90 mm	30241165	4536

Accessories	Item No.	Price USD
Pan Holder, MB90 MB120	30246947	55
In-Use-Cover, Accessory, MB90 MB120	30284478	63
Scoop, Accessory, MB90 MB120	30284477	39
Temperature Calibration Kit	11113857	477
Anti-Theft Device	80850043	185
Pan, Aluminum, Set(80), MB Series	80850086	51

Accessories	Item No.	Price USD
Filter, Glass Fiber, Set(200)	80850087	83
Cage, Sample, MB Series	80252477	82
Pan, Reusable, Set(3), 7 mm, MB Series	80252478	68
Pan, Reusable, Set(3), 14 mm, MB Series	80252479	72
Printer, Impact, SF40A	30064203	798
Cable, ST103-AV DV EX MB PA TxxP	80252581	155
Printer, Thermal, STP-103, US	80251992	622
Software, Winwedge	80850080	437



MB90

Combining Speed and Precision in One Moisture Analyzer —Test More Samples in Less Time

- The MB90's precisely controlled halogen heating dries samples quickly, and ensures uniform heating to yield fast, precise and repeatable results of 0.01% readability.
- Designed with effortless maintenance in mind, the MB90 features a removable pan handler and heating chamber components that make cleaning quick and easy - no tools needed.
- Icon-based menu navigation on the easy-to-read touchscreen display makes operating the MB90 intuitive. Perform routine sample testing in three easy steps – no training required.



- Application** Percent Moisture Determination, Percent Solid Determination, Weighing
- Display** 4.3" TFT color touchscreen display
- Operation** Power cord (included)
- Communication** RS232 with GLP/GMP data output, USB Host and USB Device (included)
- Construction** Metal base, ABS top housing, halogen heat source, stainless steel pan support, stainless steel pan handler, in-use cover
- Design Features** Three shut-off criteria (manual, timed or auto), two drying profiles (standard and fast), storage for up to two methods, 40°C to 200°C heating temperature range (1°C increments), 13 operational languages

Model	Capacity	Readability	Moisture Readability	Pan Size	Item No.	Price USD
MB90	90 g	1 mg	0.01 %	90 mm	30241164	3570

Accessories	Item No.	Price USD
Pan Holder, MB90 MB120	30246947	55
In-Use-Cover, Accessory, MB90 MB120	30284478	63
Scoop, Accessory, MB90 MB120	30284477	39
Temperature Calibration Kit	11113857	477
Anti-Theft Device	80850043	185
Pan, Aluminum, Set(80), MB Series	80850086	51

Accessories	Item No.	Price USD
Filter, Glass Fiber, Set(200)	80850087	83
Cage, Sample, MB Series	80252477	82
Pan, Reusable, Set(3), 7 mm, MB Series	80252478	68
Pan, Reusable, Set(3), 14 mm, MB Series	80252479	72
Printer, Impact, SF40A	30064203	798
Cable, ST103-AV DV EX MB PA TxxP	80252581	155
Printer, Thermal, STP-103, US	80251992	622
Software, Winwedge	80850080	437



MB27

The Affordable High Capacity Moisture Analyzer

- The MB27 provides accurate results at 0.01% 0.001 g. With a large capacity of 90 g, it is ideal for food, agriculture, chemical, pharmaceutical and other applications that require measurements up to 0.01% 0.001 g.
- Set up and operation is extremely easy. Just press and hold the temperature or time buttons to set drying parameters. The MB27 is ideal for routine tasks performed by operators of all skill levels.
- The compact footprint (17x14x28 cm) of the OHAUS MB27 is designed to take up less space. The easy-to-clean heating chamber is ideal for frequent use and inexpensive maintenance.



- Application** Percent Moisture Determination, Percent Solid Determination, Weighing
- Display** Backlit liquid crystal display (LCD)
- Operation** Power cord (included)
- Communication** RS232 (included)
- Construction** Halogen heat source, ABS housing, metal pan support, metal pan handler, in-use cover
- Design Features** 3 shut off criteria (manual, timed or auto), 1 standard heating profile, 50° to 160° C heating range (5° C increments)

Model	Capacity	Readability	Moisture Readability	Pan Size	Item No.	Price USD
MB27	90 g	1 mg	0.01 %	90 mm	30251683	2750

Accessories	Item No.	Price USD
Temp. Calibration Kit, MB Series	11113857	477
Holder, Pan, MB23 MB27	11113873	116
Printer, Impact, SF40A, AM	30064203	798
Printer, Thermal, STP-103, US	80251992	622
In-Use-Cover, MB23 MB27	80252475	31
Pan Holder MB23 MB27	80252476	63
Cage, Sample, MB Series	80252477	82
Pan, Reusable, Set(3), 7 mm, MB Series	80252478	68

Accessories	Item No.	Price USD
Pan, Reusable, Set(3), 14 mm, MB Series	80252479	72
Cable, ST103-AV DV EX MB PA TxxP	80252581	155
Cable, RS232, IBM 9P, AV DV MB Ranger	80500525	155
Cable, SF42-AV DV MB Ranger	80500571	155
Anti-Theft Device, MB AX EX	80850043	185
Software, Winwedge	80850080	437
Pan, Aluminum, Set(80), MB Series	80850086	51
Filter, Glass Fiber, Set(200)	80850087	83



MB23

Redefining Value in Moisture Analysis

- The MB23 utilizes a metallic sheathed, no glass infrared heating element for drying of samples.
- With a bright backlit LCD and easy one-button setup and menu navigation, MB23 is extremely user-friendly.
- MB23 is very easy-to-clean to ensure the integrity of your samples, and its compact design allows it to fit seamlessly into most workspaces.



- Application** Percent Moisture Determination, Percent Solid Determination, Weighing
- Display** Backlit liquid crystal display (LCD)
- Operation** Power cord (included)
- Communication** RS232 (included)
- Construction** Infrared heat source, ABS housing, metal pan support, metal pan handler, in-use cover
- Design Features** 3 shut off criteria (manual, timed or auto), 1 standard heating profile, 50° to 160° C heating range (5° C increments)

Model	Capacity	Readability	Moisture Readability	Pan Size	Item No.	Price USD
MB23	110 g	10 mg	0.1 %	Ø 3.5 in / Ø 90 mm	83999801	2650

Accessories	Item No.	Price USD
Temp. Calibration Kit, MB Series	11113857	477
Holder, Pan, MB23 MB27	11113873	116
Printer, Impact, SF40A, AM	30064203	798
Printer, Thermal, STP-103, US	80251992	622
In-Use-Cover, MB23 MB27	80252475	31
Pan Holder MB23 MB27	80252476	63
Cage, Sample, MB Series	80252477	82
Pan, Reusable, Set(3), 7 mm, MB Series	80252478	68

Accessories	Item No.	Price USD
Pan, Reusable, Set(3), 14 mm, MB Series	80252479	72
Cable, ST103-AV DV EX MB PA TxxP	80252581	155
Cable, RS232, IBM 9P, AV DV MB Ranger	80500525	155
Cable, SF42-AV DV MB Ranger	80500571	155
Anti-Theft Device, MB AX EX	80850043	185
Software, Winwedge	80850080	437
Pan, Aluminum, Set(80), MB Series	80850086	51
Filter, Glass Fiber, Set(200)	80850087	83



D500M

Economical Mechanical Bench Scale for Basic Industrial Applications

- Heavy-duty mechanical epoxy-painted steel construction makes D500M highly durable for industrial applications.
- Phenolic wheels allow for mobility and a beam lock is integrated to protect the indicator when the scale is in motion.
- Counterpoise weights allow for a maximum capacity of 1,000 lbs.

Display Easy-to-read, dual-side flat beam with a shadow-proof poise

Construction Epoxy painted steel, phenolic wheels



Model	Capacity	Readability	Certified Readability	Platform Size	Item No.	Price USD
D500M	1000 lb	0.5 lb	0.5 lb	28.13 in x 19.25 in / 714 mm x 489 mm	80252735	1265



Heavy Duty Solution

The Industry Standard for Precision and High Capacity Mechanical Weighing

- Oversized stainless steel platform to accommodate large samples or containers.
- A lockable Tare feature allows the operator to tare the balance once for multiple weighing procedures for containers up to 2270 g.
- Covers protect the self-aligning bearings which require little to no maintenance.

Display Front and rear indicator plate

Construction Metal base and beam, stainless steel pan



Model	Capacity	Readability	Pan Size	Item No.	Price USD
1119-D0	20 kg	1 g	Ø 11 in / Ø 279 mm	80000000	2091

Accessories	Item No.	Price USD
Weight Set, Metric, 1119-D0	80780008	212



Field Test

Accurate Weighing Even Under Adverse Conditions

- The Field Test scale is available to provide weighing results rain or shine. Without the restrictions of connecting the scale to an outlet, weighing can be conducted in any setting.
- The large stable pan will hold oversized samples without tipping, and the weighted base keeps the entire scale extremely steady.
- The portable Field Test scale can be easily moved from location to location around your work site with the integrated carrying handle.



- Display** Sliding poise and graduated beam
- Construction** Metal base and beam, oversized stainless steel pan
- Design Features** Magnetic damping, positive load stops

Model	Capacity	Readability	Pan Size	Item No.	Price USD
2400-12	36 lb	0.01 lb	Ø 11 in / Ø 279 mm	80000038	1333
2400-11	16 kg	5 g	Ø 11 in / Ø 279 mm	80000008	1286



Triple Beam Pro®

Best-in-Class Mechanical Balance

- The unique, easy-grip carrying handle is ergonomically designed to allow for effortless movement around the classroom.
- A convenient compartment provides a place to store the included weight set when not in use, preventing the weights from becoming lost.
- Prevent theft and accidental dropping by securing the balance to a desk or bench top with the security loop or Kensington-type lock (sold separately).



- Display** Easy-to-read deep-notched, tiered beams and dial plates
- Construction** Metal base and beam, stainless steel pan
- Design Features** Two notched and tiered beams, positive poise positioning, spring loaded zero adjust compensator, self-aligning beam design, magnetic damping to minimize oscillation and speed weighing, security loop, included weight set and storage compartment. Includes rod & clamp assembly for below balance weighing.

Model	Capacity	Readability	Pan Size	Item No.	Price USD
TP2611 with Rod and Clamp	2610 g	0.1 g	5.8 in x 5.8 in / 147 mm x 147 mm	80621692	198

Accessories	Item No.	Price USD
Kit, Rod and Clamp	80780011	60
Dust Cover, Triple Beam	80780017	32
Weight Set, 2 x 1 kg, 1 x 500 g	80780108	61
Anti-Theft Device, SP PA AV NV	80850000	72
Anti-Theft Device, MB AX EX	80850043	185



Triple Beam 700 Series

The Standard by Which All Other Mechanical Balances Are Measured

- Superior magnetic damping provides stable results three times faster than any other three-beam balance on the market.
- Five weighing pans of different sizes and designs can accommodate materials for a variety of weighing applications.
- A counterbalancing knob provides quick zeroing of the balance while a self-aligning beam helps ensure accurate results.

Display Easy to-read deep-notched, tiered beams and dial plates

Design Features Metal base and beam, stainless steel pan

Construction Easy-to-read notched and tiered beams, self-aligning beam design, magnetic damping to minimize oscillation and speed weighing, zero adjust compensator



Model	Tare Beam	Capacity	Readability	Pan Size	Pan Height	Pan Type	Item No.	Price USD
720-00		610 g	0.1 g	12 in x 6 in / 30.5 mm x 152 mm	2.75 in/70 mm	Polypropylene Scoop	80000032	294
720-50				12 in x 7.4 in / 305 mm x 188 mm	1.7 in/43 mm	Stainless Steel Scoop	80000033	341
710-00				Ø 6 in / Ø 152 mm	—	Removable Pan	80000011	249
750-50						Fixed Pan	80000012	138
760-00	•					80000013	258	
710-T0	•			Removable Pan	80000031	305		
730-00				Ø 9 in / Ø 229 mm	6 in/152 mm	Animal Container	80000034	368

Accessories	Item No.	Price USD
Subject Box	80000053	83
Scoop and Counter Weight	80780001	49
Scoop, PP, 0.8 l	80780006	32
Kit, Rod and Clamp	80780011	60
Scoop and Counter Weight, Poly	80780014	44
Scoop and Counter Weight, SST	80780015	103

Accessories	Item No.	Price USD
Scoop and Counter Weight, 1.75 l	80780016	47
Dust Cover, Triple Beam	80780017	32
Weight Set, 2 x 1 kg, 1 x 500 g	80780108	61
Anti-Theft Device, SP PA AV NV	80850000	72
Clamp, Gas Cylinder	80850312	79



Weighing

Triple Beam Junior

All the Benefits of a Triple Beam, Just for Younger Students

- The notched and tiered beams provide for easy reading of measurement results.
- Prevent theft and accidental dropping by securing the balance to a desk or bench top with the security loop (sold separately).
- The zero adjust compensator ensures the balance is at zero and weighing results will be accurate.



Display Easy to-read deep-notched, tiered beams and dial plates

Construction Metal base and beam, stainless steel pan

Design Features Notched and tiered beams, magnetic damping, zero adjust compensator

Model	Capacity	Readability	Pan Size	Item No.	Price USD
TJ611	610 g	0.1 g	Ø 5.9 in / Ø 150 mm	80252052	130

Accessories	Item No.	Price USD
Dust Cover, Triple Beam	80780017	32
Anti-Theft Device, SP PA AV NV	80850000	72



Triple Beam Dial-O-Gram® 1600 Series

The Standard by Which All Others Are Measured

- Superior magnetic damping provides three times faster stability reading than any other three-beam balance on the market.
- Vernier dial convenience.
- Counterbalancing knob for quick zeroing, self-aligning beam design.



Display Easy to-read deep-notched, tiered beams and dial plates

Construction Metal base and beam, stainless steel pan

Design Features Counterbalancing knob for quick zeroing, positive poise positioning for repeatable results, self-aligning beam design, magnetic damping to minimize oscillation and speed weighing.

Model	Tare Beam	Capacity	Readability	Pan Size	Pan Type	Item No.	Price USD
1650-00	•	610 g	0.1 g	Ø 6 in / Ø 152 mm	Fixed Plate	80000006	323
1610-00	•				Removable Pan	80000036	373
1650-W0	•	2610 g			Fixed Plate and attachment weights	80000037	373

Accessories	Item No.	Price USD
Scoop, Flat Bottomed, SST, 0.6 l	80250400	59
Scoop and Counter Weight	80780001	49
Scoop, PP, 0.8 l	80780006	32
Kit, Rod and Clamp	80780011	60
Scoop and Counter Weight, Poly	80780014	44
Scoop and Counter Weight, SST	80780015	103

Accessories	Item No.	Price USD
Scoop and Counter Weight, 1.75 l	80780016	47
Dust Cover, Triple Beam	80780017	32
Weight Set, 2 x 1 kg, 1 x 500 g	80780108	61
Anti-Theft Device, SP PA AV NV	80850000	72
Clamp, Gas Cylinder	80850312	79



Dial-O-Gram® and Cent-O-Gram® 300 Series Extremely Precise Mechanical Balance with High Readability

- With aluminum pressure castings for the base and beam assembly, agate bearings, steel knife-edges, and stainless steel pan, the Dial-O-Gram is built to the highest standard of quality.
- The three-point base, special floating bearing principle and beam design eliminates the need for level adjustments.
- The self-aligning beam ensures accurate results are garnered effortlessly.

- Display** Easy to-read deep-notched, tiered beams and dial plates
- Construction** Metal base and beam, stainless steel pan
- Design Features** Self-aligning beam design, magnetic damping to minimize oscillation and speed weighing, zero adjust compensator



Model	Capacity	Readability	Beams	Pan Size	Pan Height	Pan Type	Item No.	Price USD
310-00	310 g	0.01 g	2 Beams with Dial	Ø 3.5 in / Ø 89 mm	0.5 in / 13 mm	Removable Pan	80000009	359
311-00	311 g		4 Beams				80000010	296

Accessories	Item No.	Price USD
Dust Cover, Dial-O-Gram Cent-O-Gram	80780005	32
Anti-Theft Device, SP PA AV NV	80850000	72



Harvard Junior Two Pan Balance Designed to Teach Comparative Weighing

- The easy-grip carrying handle will help students and teacher alike securely move the balances around the classroom.
- The balances can be stacked to minimize the amount of storage space needed, and the lock feature protects the balance from damage when in storage.
- An eight piece weight set and bowls that fit on the weighing pans are included with every Harvard Junior.

- Display** Steel pointer
- Construction** ABS base, pans and bowls, metal beam
- Design Features** Manual damping device, spring-loaded zero adjust compensator
Includes teacher-developed activity guide



Model	Capacity	Readability	Pan Size	Item No.	Price USD
HJ2001	2000 g	0.5 g	Ø 6 in / Ø 150 mm	80252050	111



Harvard Trip®

Two Pan Balance Designed for Comparative Weighing

- The built-in sliding masses make weighing very simple and quick.
- Magnetic damping minimizes oscillation and helps speed up weighing.
- A counterbalancing knob provides quick zeroing of the balance while floating agate bearings help ensure accurate results.

Display Deep notched and tiered beams

Construction All-metal base and beam, stainless steel pan

Design Features Weight set (2000 g model, accessory sold separately), built-in sliding masses, magnetic damping, self-aligning beam design and floating agate bearings, counterbalancing knob for quick zeroing, hardened steel edges



Model	Capacity	Readability	Beams	Pan Size	Item No.	Price USD
1450-SD	2000 g	0.1 g	Single Beam	Ø 6.2 in / Ø 152 mm	80000003	335
1550-SD			2 Beams		80000004	360
1560-SD			2 Beams and Tare Beam		80000005	376

Accessories	Item No.	Price USD
Scoop, PP, 0.8 l	80780006	32
Kit, Rod and Clamp	80780011	60
Scoop and Counter Weight, Poly	80780014	44
Scoop and Counter Weight, SST	80780015	103

Accessories	Item No.	Price USD
Scoop and Counter Weight, 1.75 l	80780016	47
Anti-Theft Device, SP PA AV NV	80850000	72
Weight Set, 1 kg-1 g, ASTM 6, CYL	80850115	432
Dust Cover, Storage, Harvard	80850262	32



Weighing

School Balance

The Young Scientist's First Balance

- Large, washable pans provide optimal space for samples to be weighed.
- 18 piece, color coded stackable plastic mass set included.
- Front and rear pointers allow students to view results from both sides of the balance.

Display Plastic pointer

Construction ABS base, beam, and pans

Design Features Zero adjust compensator



Model	Capacity	Readability	Pan Size	Item No.	Price USD
SB1200	2000 g	0.5 g	5.5 in x 5.5 in / 140 mm x 140 mm	80000029	54



Weighing

Primer[®] Balance

The Scale for Budding Scientists

- An activity guide with 16 exercises is included with every Primer balance.
- The easy-to-slide zero adjustment weight makes ensuring the balance is ready for weighing very simple.
- Front and rear pointers allow students to view results from both sides of the balance.

Display Plastic pointer

Construction ABS base, beam, and pans

Design Features Large, washable weighing pans, dual pointers, 18 piece stackable plastic mass set



Model	Capacity	Readability	Pan Size	Item No.	Price USD
80410-00	2000 g	1 g	4 in x 4 in / 102 mm x 102 mm	80000024	39



Weighing

Spring Scales

Producing Reproducible Results at Unbeatable Prices

- Pull type spring scales feature an internal spring mechanism and offer a versatile and inexpensive way to display measurements in grams, ounces, pounds and Newtons.
- Dial type spring scales offer a versatile and inexpensive weight determination in classrooms, laboratories, field studies and much more.
- Demonstration spring scales offer a large faceplate for easy viewing and are ideal for all basic weighing applications.

Display Dial plates

Construction ABS housing with metal face plate, pointer, spring and hook

Design Features Large bright colored dial face, easy-to-read black graduations on a frosted aluminum background

Pull Type Spring Scales

Model	Capacity	Readability	Item No.	Price USD
8001-MA	9 oz / 250 g	0.25 oz / 10 g	80000039	19
8002-MA	18 oz / 500 g	0.5 oz / 20 g	80000041	19
8004-MA	72 oz / 2000 g	2 oz / 50 g	80000044	19
8001-MN	250 g / 2.5 N	10 g / 0.1 N	80000014	18
8002-MN	500 g / 5 N	20 g / 0.2 N	80000015	18
8003-MN	1000 g / 10 N	25 g / 0.25 N	80000016	18
8004-MN	2000 g / 20 N	50 g / 0.5 N	80000017	18
8008-MN	5000 g / 50 N	100 g / 1 N	80000018	18
8261-MO	100 g	1 g	80000025	21
8262-MO	200 g	2 g	80000026	21
8263-MO	500 g	5 g	80000027	21
8264-MO	1000 g	10 g	80000028	21
8265-MO	2000 g	20 g	80000052	21
8001-PN	0.56 lb / 2.5 N	0.02 lb / 0.1 N	80000040	22
8002-PN	1.12 lb / 5 N	0.04 lb / 0.2 N	80000042	22
8003-PN	2.25 lb / 10 N	0.05 lb / 0.25 N	80000043	22
8004-PN	4.5 lb / 20 N	0.125 lb / 0.5 N	80000045	22
8008-PN	11.25 lb / 50 N	0.25 lb / 1 N	80000046	22



Dial Type Spring Scales

Model	Capacity	Readability	Item No.	Price USD
8011-MA	9 oz / 250 g	0.125 oz / 2 g	80000047	30
8012-MA	18 oz / 500 g	0.25 oz / 5 g	80000048	30
8014-MA	2000 g / 72 oz	20 g / 0.5 oz	80000049	30
8011-MN	250 g / 2.5 N	2 g / 0.02 N	80000019	29
8012-MN	500 g / 5 N	5 g / 0.05 N	80000020	29
8014-MN	2000 g / 20 N	20 g / 0.2 N	80000022	29
8013-MN	1000 g / 10 N	10 g / 0.1 N	80000021	30
8016-00	20 N	1 / 2 N	80000023	60
8015-00	22 hg	1 / 2 hg	80000050	60
8018-50	50 N	2 N	80000051	67



Weighing

Industrial Weighing



OHAUS offers a full line of products designed for industrial applications, including sophisticated, newly released software for our most powerful products. From shipping scales up to 10,000 lb floor scales, OHAUS has a product for use in every area of your facility.



Industrial Scale Selector Guide

	Compact Bench Scales										Retail	Counting Scales			Modular Bench Scales				
	Ranger 7000	Ranger 4000	Ranger 3000	FD	Valor 7000	Valor 4000	Valor 3000	Valor 2000	Valor 1000	Catapult 1000	Aviator 7000	Ranger 7000	Ranger Count 4000	Ranger Count 3000	VX/VN Floor	Defender 5000/7000	Defender 3000	CKW	ES / SD
Weighing Capacity Range (lb)	6 to 150	6 to 60	3 to 60	6 to 30	3 to 60	3 to 30	0.4 to 13.2	3 to 60	6 to 66	20 to 165	30 or 60	6 to 150	6 to 60	3 to 60	2,500 to 10,000	25 to 600	30 to 660lb	6 to 60	13 to 440
lb, oz, lb:oz	all	all	all	all	all	all	all	all	lb, oz	lb	lb	all	all	all	all	all	all	all	ES - all SD lb
kg or g	•	•	•	•	•	•	•	•	•	kg		•	•	•	•	•	•	•	ES - all SD - kg
Parts Counting	•	•	•									•	•	•	•	•	•		•
Checkweighing	•	•	•	•	•	•		•*	•			•	•	•		•		•	
Percent Weighing	•	•	•	•	•	•	•					•				•		•	
Display Hold / Dynamic Weighing	•	•	•							•	•	•				•			SD only
Totalization / Accumulation		•	•		•	•					•		•	•		•		•	
Retail Price/Lb											•								
NTEP Certified or Measurement Canada Approved	•	•	•	•*	•	•	NTEP*				NTEP	•	•	•	NTEP**	•	•	•	
Full Color Display	•											•							
VGA	•											•							
LCD										•			•						•
Backlit LCD			•	•	•		•		•		•			•	•	•	•		
LED		•				•		•										•	
Numeric Keypad	•A										•	•A	•	•		•A (7000)		•	
Metal Housing	•	•										•	•		• Base	•* Base			
ABS Housing			•		•*			•*	•	•	•			•	•* Indicator	•* Indicator	•* Indicator	•* Indicator	•* Indicator
Stainless Steel Housing				•	•*	•	•*								•* Indicator	•* Indicator	•* Indicator	•* Indicator	•* Indicator
Washdown IP/ NEMA Rating					X8	65 / 4X *	X8									66 / 4X *	65 / 4X *	66 / 4X	
NSF Listed/ Certified				•	•	•	•	•										•	
RS232	•	•	•		•							•	•	•	•	•	•	•	
^{2nd} RS232	0	0	0		0							0	0	0		0			
RS485/422															0			0	
USB	•	0	0		0							•	0	0	0*	0*	0*		
Ethernet	0	0	0		0							0	0	0	0*	0*	0*		
GMP w/Time/Date	•											•				•		•	
AC or DC Relays / Discrete I/O	0											0			0			0	
Rechargeable Battery	0	•	•	•	•	•		•	•	0	0	•	•	•	0	•	0	0	
Disposable Batteries						•				•					•*				•
Remote Scale Base Input	0	0										0	0	0		•* (7000)			
Page No.	51	52	53	55	54	56	57	58	59	59	72	48	49	50	35-36	38-43	44-45	37	46-47

0 Optional A Alphanumeric **by base chosen *on specific models

VX Series

Economical Floor Scale for Basic Industrial Applications



- VX is ruggedly constructed and includes an epoxy painted steel frame, a NEMA 4X/IP65 stainless steel indicator, NEMA 4X/IP67 sealed plastic junction box and IP67 sealed load cells.
- The included internal rechargeable battery keeps the scale running and allows for placement of the platform away from outlets while the backlit LCD projects large 1" digits.
- Weighing and counting modes produce results in five weighing units, and the included RS232 provides the ability to connect the scale to a printer or PC for data reporting purposes.

- Application** Weighing, Parts Counting
- Display** Backlit liquid crystal display (LCD)
- Operation** Power cord (included) or rechargeable battery (included)
- Communication** Easy access communication port with RS232 interface (included)
- Construction** NEMA 4X/IP65 stainless steel indicator with hinged front-cover, 5mm fixed top plate, wall bracket, epoxy painted steel platform and frame, NEMA 4/IP67 plastic junction box with side access, 4 IP67 NTEP alloy steel load cells
- Design Features** 125% overload protection

Model	Capacity	Readability	Certified Readability	Platform Size	Item No.	Price USD
VX32XW5000X	5000 lb / 2200 kg	1 lb / 0.5 kg	—	5 ft x 5 ft / 1,524 mm x 1,524 mm	80253296	2755
VX32XW10000L	10000 lb / 4500 kg	2 lb / 1 kg		4 ft x 4 ft / 1,219 mm x 1,219 mm	80253297	3045
VX32XW10000X				5 ft x 5 ft / 1,524 mm x 1,524 mm	80253298	3475

Approved Model	Capacity	Readability	Certified Readability	Platform Size	Item No.	Price USD
VX32XW2500L	2500 lb / 1000 kg	0.5 lb / 0.2 kg	0.5 lb / 0.2 kg	4 ft x 4 ft / 1,219 mm x 1,219 mm	80253294	2405
VX32XW5000L	5000 lb / 2200 kg	1 lb / 0.5 kg	1 lb / 0.5 kg	4 ft x 4 ft / 1,219 mm x 1,219 mm	80253295	2405

Accessories	Item No.	Price USD
Printer, Impact, SF40A, AM	30064203	798
Printer, Thermal, STP-103, US	80251992	622
Foot Kit, Set(4), VX	80252545	96
Foot Plate, Set(2), Painted, VX	80252548	69
Column Kit, Painted, Floor Scale	30047153	86
Column Kit, Stainless Steel, Floor Scale	30047154	204

Accessories	Item No.	Price USD
Ramp, 48 in wide x 48 in long, 2.5 K/5 K, VX	80252766	832
Ramp, 60 in wide x 48 in long, 5 K, VX	80252767	1050
Ramp, 48 in wide x 48 in long, 10 K, VX	80252795	1716
Ramp, 60 in wide x 48 in long, 10 K, VX	80252796	1899
Bolt Kit, Floor, VX	80252838	23
Cable, RS232, IBM 9P, AV DV MB Ranger	80500525	155
Cable, RS232, CKW TxxXW	80500552	142
Software, Winwedge	80850080	437
Interface Kit, RS232-USB	30304101	116
Interface Kit, RS232-Ethernet	30304102	116

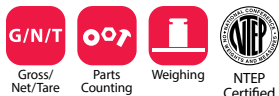

VN Series

Economical Painted Steel Floor Scales for Basic Industrial Applications



- The durable VN is constructed of an epoxy painted steel frame, an ABS T31P indicator, NEMA 4X/IP65 sealed stainless steel junction box and IP67 sealed load cells.
- With a rechargeable lead acid battery included with each VN, you can position the floor scale freely in the workspace without having to be forced to work near an outlet.
- Painted steel ramps are available to be added to any VN platform, which provide bottom support ribs that prevent the platform from bending under heavy loads.

- Application** Weighing, Parts Counting
- Display** Backlit liquid crystal display (LCD)
- Operation** AC adapter (included) or rechargeable battery (included)
- Communication** Easy access communication port with RS232 interface
- Construction** ABS plastic indicator, black painted steel treaded platform, NEMA 4X/IP65 stainless steel junction box with side access, IP67 NTEP alloy steel load cells, two carbon steel eye bolts, four self-swiveling ball-in-cup feet, black painted steel ramps and fixed location foot mounting plate kits (accessories sold separately)

Design Features 125% overload protection

Model	Capacity	Readability	Certified Readability	Platform Size	Item No.	Price USD
VN31P5000L	5000 lb / 2500 kg	1 lb / 0.5 kg	1 lb / 0.5 kg	4 ft x 4 ft / 1,219 mm x 1,219 mm	80252563	1525
VN31P5000X				5 ft x 5 ft / 1,524 mm x 1,524 mm	80252564	1785

Accessories	Item No.	Price USD
Column Kit, Painted, Floor Scale	30047153	86
Column Kit, SST, Floor Scale	30047154	204
Printer, Impact, SF40A, AM	30064203	798
Foot Plate, Set(2), Painted, VE VN	72198344	46
Printer, Thermal, STP-103, US	80251992	622

Accessories	Item No.	Price USD
Ramp, 48 in wide x 26.4 in long, Painted, VN	80252565	630
Ramp, 60 in wide x 26.4 in long, Painted, VN	80252566	718
Cable, RS232, IBM 9P, AV DV MB Ranger	80500525	155
Software, Winwedge	80850080	437
Interface Kit, RS232-USB	30304101	116
Interface Kit, RS232-Ethernet	30304102	116

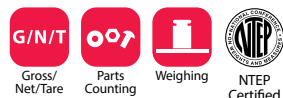

VN Series Floor Scale Platforms

Basic Level Floor Scale Bases

- Durable epoxy painted steel frame and platform
- NEMA4X/IP65 sealed stainless steel junction box
- IP67 sealed loadcells



Construction Black painted steel platform, raised embossed treads, fixed top plate 5mm thick, four IP67 NTEP alloy steel load cells, NEMA 4X/IP65 stainless steel junction box with side access, self swiveling stainless steel ball in cup leveling feet.

Design Features Ball-in-Cup Leveling Feet, Steel Eye Bolts for Easy Lifting and Positioning

Model	Capacity	Readability	Certified Readability	Platform Size	Item No.	Price USD
VN5000L	5000 lb / 2500 kg	1 lb / 0.5 kg	1 lb / 0.5 kg	4 ft x 4 ft / 1,219 mm x 1,219 mm	80252561	1312
VN5000X				5 ft x 5 ft / 1,524 mm x 1,524 mm	80252562	1536



CKW Checkweigher

Advanced Checkweighing Bench Scale for Food Processing Use

- The CKW features multiple Checkweighing options including Positive, Negative, Zero or Net and statistical capabilities to provide accurate results for advanced Checkweighing needs.
- CKW is NSF Certified, USDA-AMS Accepted, and supports HACCP-certified systems, and is safe for use in food processing applications.
- The base's open framework can be thoroughly cleaned to eliminate the risk of contamination caused by residue build up.



Application Weighing, Checkweighing

Display Light emitting diode (LED) display, 24 segment traffic light LED bar graph

Operation AC power (included) or rechargeable battery (accessory sold separately)

Communication Easy access communication port including RS232 interface and external tare input (included) and RS422/485 or AC/DC relay outputs (accessories sold separately)

Construction NEMA 4X/IP66 stainless steel indicator, 304 grade stainless steel platform with no visible threads, rounded corners, drain holes, extended skirt and open frame, IP67 stainless steel load cell, stainless steel column and wall bracket, level indicator

Design Features Simple plug and play installation of accessories, 20 part library, 3-color 24-segment bar graph, beeper, and weight display alert Checkweighing indications, NSF listed and USDA-AMS accepted, Checkweighing target settings by range



Model	Protection Rating	Capacity	Readability	Certified Readability	Platform Size	Item No.	Price USD
CKW3R55	IP66	6 lb / 3 kg	0.001 lb / 0.5 g	0.002 lb / 1 g	10 in x 10 in / 254 mm x 254 mm	80251041	1469
CKW6R55		15 lb / 6 kg	0.002 lb / 1 g	0.005 lb / 2 g	10 in x 10 in / 254 mm x 254 mm	80251042	1469
CKW15L55		30 lb / 15 kg	0.005 lb / 2 g	0.01 lb / 5 g	12 in x 12 in / 305 mm x 305 mm	80251043	1574
CKW30L55		60 lb / 30 kg	0.01 lb / 5 g	0.02 lb / 10 g	12 in x 12 in / 305 mm x 305 mm	80251044	1574

Accessories	Item No.	Price USD
Wall Mount Kit, SST, CKW	71167964	194
Rechargeable Battery Kit, CKW	71167966	371
Relay Kit, AC, CKW	71167967	392
Relay Kit, DC, CKW	71173377	392
Cable, RS232, CKW TxxXW	80500552	142
Software, Winwedge	80850080	437



Defender® 7000

High Performance Bench Scales for Advanced Applications

- Defender 7000 has advanced features such as accumulation mode, a 128-item library and optional alibi memory capability, as well as a 1:15,000 maximum displayed resolution.
- This advanced scale has dual-scale capabilities in which it can display the weights from two platforms and is powerful enough to drive up to 8 - 350 ohm load cells per platform.

Application Weighing, Parts Counting, Percent Weighing, Checkweighing, Dynamic/Animal Weighing, Accumulation, Display Hold

Display Backlit liquid crystal display (LCD) with secondary information line, 3 color Checkweighing LEDs

Operation Power cord (included) or rechargeable battery (accessory sold separately)

Communication Easy access communication port including RS232 (included) and 2nd RS232 or RS422/RS485 (accessories sold separately). GLP/GMP data output with real-time clock

Construction Bench scales with "W" bases are IP66 washdown protected with IP66 stainless steel indicator, IP67 stainless steel load cell, 304 stainless steel column, pan and form-and-weld base frame. Bench scales with "H" bases are IP66 washdown protected IP66 stainless steel indicator, IP67 aluminum load cell, 304 grade stainless steel pan with black polyurethane painted steel column and form-and-weld frame.

Design Features Alibi memory kit (accessory sold separately), 150% overload capacity protection, five operating languages, NTEP Certified and Measurement Canada Approved



Model	Protection Rating	Capacity	Readability	Certified Readability	Platform Size	Item No.	Price USD
D71XW10WR3	IP66; NEMA 4X	20 lb / 10 kg	0.002 lb / 1 g	0.005 lb / 2 g	12 in x 12 in / 305 mm x 305 mm	80501537	1530
D71XW15HR1	Not Applicable	30 lb / 15 kg			14 in x 12 in / 355 mm x 305mm	80501358	1580
D71XW25WR3	IP66; NEMA 4X	50 lb / 25 kg	0.005 lb / 2 g	0.01 lb / 5 g	12 in x 12 in / 305 mm x 305 mm	80501538	1556
D71XW30HR1	Not Applicable	60 lb / 30 kg			14 in x 12 in / 355 mm x 305 mm	80501359	1580
D71XW50WL4	IP66; NEMA 4X	100 lb / 50 kg	0.01 lb / 5 g	0.02 lb / 10 g	18 in x 18 in / 457 mm x 457 mm	80501539	2412
D71XW60HR1	Not Applicable	150 lb / 60 kg			14 in x 12 in / 355 mm x 305 mm	80501360	1580
D71XW60HL2			19.7 in x 15.7 in / 500 mm x 400 mm	80501361	1772		
D71XW100HL2	IP66; NEMA 4X	250 lb / 100 kg	0.02 lb / 10 g	0.05 lb / 20 g	19.7 in x 15.7 in / 500 mm x 400 mm	80501362	1772
D71XW100WL4					18 in x 18 in / 457 mm x 457 mm	80501540	2412
D71XW150HX2	Not Applicable	300 lb / 150 kg	0.1 lb / 50 g	0.1 lb / 50 g	21.7 in x 16.5 in / 550 mm x 420 mm	80501363	1945
D71XW250WX4	IP66; NEMA 4X	500 lb / 250 kg			24 in x 24 in / 610 mm x 610 mm	80501541	2776
D71XW300HX2	Not Applicable	600 lb / 300 kg	0.05 lb / 20 g	0.2 lb / 100 g	21.7 in x 16.5 in / 550 mm x 420 mm	80501364	2106

Accessories	Item No.	Price USD
Printer, Impact, SF40A, AM	30064203	798
Printer, Thermal, STP-103, US	80251992	622
PCBA Kit, Alibi Memory, R71 T71	80500503	97
Cable, RS232, CKW TxxXW	80500552	142
Relay Kit, AC, T51 T71	80500720	282
Wheel Kit, Defenders	30372146	105

Accessories	Item No.	Price USD
Relay Kit, DC, T51 T71	80500727	242
Rechargeable Battery Kit, T51 T71	80500729	182
RS422/485 Kit, T51 T71	80500731	79
RS232 Kit, T51 T71	80500733	59
Wall Mount Kit, SST, T51XW T71XW	80500735	65
Software, Winwedge	80850080	437
Column Kit, Painted, Floor Stand	30047153	86
Column Kit, Stainless Steel, Floor Stand	30047154	204



Defender® 7000

High Performance Bench Scales for Advanced Applications

- Defender 7000 has advanced features such as accumulation mode, a 128-item library and optional alibi memory capability, as well as a 1:15,000 maximum displayed resolution.
- This advanced scale has dual-scale capabilities in which it can display the weights from two platforms and is powerful enough to drive up to 8 - 350 ohm load cells per platform.
- The ultra-durable Defender 7000 has a stainless steel platform, painted form-and-weld frame, column, and indicator bracket, aluminum IP67 load cell as well as an ABS indicator.



- Application** Weighing, Parts Counting, Percent Weighing, Checkweighing, Dynamic/Animal Weighing, Accumulation, Display Hold
- Display** Backlit liquid crystal display (LCD) with secondary information line, 3 color Checkweighing LEDs
- Operation** Power cord (included) or 6 C (LR14) batteries (not included) or rechargeable battery (accessory sold separately)
- Communication** Easy access communication port including RS232 (included) and 2nd RS232 or RS422/RS485 (accessories sold separately). GLP/GMP data output with real-time clock.
- Construction** ABS plastic indicator with reversible rear cover, painted steel wall bracket and column, painted steel 304 grade stainless steel platform with black polyurethane painted steel form-and-weld frame, IP67 aluminum load cell, non-slip adjustable rubber feet
- Design Features** Alibi memory kit (accessory sold separately), 150% overload capacity protection, five operating languages, NTEP Certified and Measurement Canada Approved

Model	Capacity	Readability	Certified Readability	Platform Size	Item No.	Price USD
D71P10QR1	25 lb / 10 kg	0.002 lb / 1 g	0.005 lb / 2 g	12 in x 12 in / 305 mm x 305 mm	80501477	1246
D71P15HR1	30 lb / 15 kg		0.01 lb / 5 g	14 in x 12 in / 355 mm x 305 mm	80501303	1142
D71P25QR1	50 lb / 25 kg	0.005 lb / 2 g	0.01 lb / 5 g	12 in x 12 in / 305 mm x 305 mm	80501478	1246
D71P30HR1	60 lb / 30 kg			14 in x 12 in / 355 mm x 305 mm	80501304	1142
D71P50QL2	100 lb / 50 kg	0.01 lb / 5 g	0.02 lb / 10 g	18 in x 18 in / 457 mm x 457 mm	80501479	1385
D71P60HR1	150 lb / 60 kg			14 in x 12 in / 355 mm x 305 mm	80501305	1142
D71P60HL2		250 lb / 100 kg	0.05 lb / 20 g	19.7 in x 15.7 in / 500 mm x 400 mm	80501306	1322
D71P100HL2	19.7 in x 15.7 in / 500 mm x 400 mm			80501307	1322	
D71P100QL2	300 lb / 150 kg	0.02 lb / 10 g	0.1 lb / 50 g	18 in x 18 in / 457 mm x 457 mm	80501480	1385
D71P150HX2				21.7 in x 16.5 in / 550 mm x 420 mm	80501308	1392
D71P250QX2	500 lb / 250 kg	0.05 lb / 20 g	0.2 lb / 100 g	24 in x 24 in / 610 mm x 610 mm	80501481	1989
D71P300HX2	600 lb / 300 kg			21.7 in x 16.5 in / 550 mm x 420 mm	80501309	1549

Accessories	Item No.	Price USD
Printer, Impact, SF40A, AM	30064203	798
Wall Mount Kit, Painted, T51P T71P	72200227	47
Printer, Thermal, STP-103, US	80251992	622
PCBA Kit, Alibi Memory, R71 T71	80500503	97
Cable, RS232, IBM 9P, AV DV MB Ranger	80500525	155
Relay Kit, AC, T51 T71	80500720	282
Column Kit, Painted, Floor Stand	30047153	86
Column Kit, Stainless Steel, Floor Stand	30047154	204
Wheel Kit, Defenders	30372146	105

Accessories	Item No.	Price USD
Base Mount Kit, Painted, T51P T71P	80500722	45
Relay Kit, DC, T51 T71	80500727	242
Rechargeable Battery Kit, T51 T71	80500729	182
RS422/485 Kit, T51 T71	80500731	79
RS232 Kit, T51 T71	80500733	59
Cable Kit, Loadcell Adapter, T51 T71	80500736	56
Software, Winwedge	80850080	437
Interface Kit, RS232-USB	30304101	116
Interface Kit, RS232-Ethernet	30304102	116

Accumulation
 Checkweighing
 Display Hold
 Dynamic Weighing
 Parts Counting

Audible Alerts
 Auto Shut-Off
 Backlight
 Battery Power
 Multi-Language
 Overload Protection
 Low Battery Indicator

Environmental Filters
 External Analog Base Input
 Overload/Underload Indicators
 Rechargeable Battery

GLP Data Output
 GMP/GLP
 LED Checkweighing Indicator
 Level Indicator
 Software Lockout
 Stability Indicator
 Time/Date

NTEP Certified
 Measurement Canada Approved

Defender® 7000 Low Profile

Multi-Functional, High Quality Modular Scale For Advanced Applications



- Full alphanumeric keypad, dual-line display supporting English, Spanish or French text, Checkweighing LEDs.
- Advanced parts counting with dual-scale, dynamic weighing, percent weighing, display hold, Checkweighing, accumulation, time/date, temporary expanded 10x readability mode, library mode with 128 memory locations.
- GMP data output with date, time user ID, project ID and scale ID, statistics, lb, oz, lb:oz, g, kg, metric tonnes, user-defined custom unit.

- Application** Weighing, Display Hold, Dynamic Weighing, Counting, Checkweighing, Percent Weighing, Accumulation, Library of up to 128 items, Optional Alibi Memory
- Display** LCD display with white LED backlight, alphanumeric line and multi-language, plus 3 color checkweigh LED
- Operation** Internal universal power supply or 6 x C batteries or optional internal NiMH rechargeable battery
- Communication** RS232 Interface with GMP, Time-Date, optional RS422/485, AC/DC Relay, 2nd RS232
- Construction** ABS Indicator, 304 grade stainless steel platform pan with black polyurethane painted steel form-and weld frame, IP67 aluminium load cell, base mount bracket included
- Design Features** Alpha numeric keypad on indicator, platform with 5 or 6 point overload stops for 150% safe overload protection, NTEP Certified and Measurement Canada Approved

Model	Capacity	Readability	Certified Readability	Platform Size	Item No.	Price USD
D71P10QR5	25 lb / 10 kg	0.002 lb / 1 g	0.005 lb / 2 g	12 in x 12 in / 305 mm x 305 mm	80501487	1246
D71P15HR5	30 lb / 15 kg		0.01 lb / 5 g	14 in x 12 in / 355 mm x 305 mm	80501324	1142
D71P25QR5	50 lb / 25 kg	0.005 lb / 2 g		0.02 lb / 10 g	12 in x 12 in / 305 mm x 305 mm	80501488
D71P30HR5	60 lb / 30 kg		14 in x 12 in / 355 mm x 305 mm		80501325	1142
D71P50QL5	100 lb / 50 kg	0.01 lb / 5 g	0.05 lb / 20 g	18 in x 18 in / 457 mm x 457 mm	80501489	1385
D71P60HR5	150 lb / 60 kg			14 in x 12 in / 355 mm x 305 mm	80501326	1142
D71P60HL5				19.7 in x 15.7 in / 500 mm x 400 mm	80501327	1322
D71P100HL5	250 lb / 100 kg	0.02 lb / 10 g	0.1 lb / 50 g	19.7 in x 15.7 in / 500 mm x 400 mm	80501328	1322
D71P100QL5				18 in x 18 in / 457 mm x 457 mm	80501490	1385
D71P150HX5	300 lb / 150 kg	0.05 lb / 20 g	0.2 lb / 100 g	21.7 in x 16.5 in / 550 mm x 420 mm	80501329	1392
D71P250QX5	500 lb / 250 kg			24 in x 24 in / 610 mm x 610 mm	80501491	1989
D71P300HX5	600 lb / 300 kg			21.7 in x 16.5 in / 550 mm x 420 mm	80501330	1549

Accessories	Item No.	Price USD
Printer, Impact, SF40A, AM	30064203	798
Wall Mount Kit, Painted, T51P T71P	72200227	47
Printer, Thermal, STP-103, US	80251992	622
PCBA Kit, Alibi Memory, R71 T71	80500503	97
Cable, RS232, IBM 9P, AV DV MB Ranger	80500525	155
Relay Kit, AC, T51 T71	80500720	282

Accessories	Item No.	Price USD
Base Mount Kit, Painted, T51P T71P	80500722	45
Relay Kit, DC, T51 T71	80500727	242
Rechargeable Battery Kit, T51 T71	80500729	182
RS422/485 Kit, T51 T71	80500731	79
RS232 Kit, T51 T71	80500733	59
Software, Winwedge	80850080	437
Interface Kit, RS232-USB	30304101	116
Interface Kit, RS232-Ethernet	30304102	116

Defender® 5000

Multifunctional Bench Scales for Standard Industrial Applications

- Defender 5000 features software for parts counting, dynamic weighing, percent weighing, Checkweighing, display hold for large containers and can meet traceability requirements.
- Multiple connectivity capabilities include built-in RS232 bi-directional interface and external input as well as optional RS422/485, second RS232 and AC or DC relay.

- Application** Weighing, Parts Counting, Percent Weighing, Checkweighing, Dynamic/Animal Weighing, Display Hold
- Display** Backlit liquid crystal display (LCD), 3 color Checkweighing LEDs
- Operation** Power cord (included) or rechargeable battery (accessory sold separately)
- Communication** Easy access communication port including RS232 (included) and 2nd RS232 or RS422/RS485 (accessories sold separately). GLP/GMP data output with real-time clock.
- Construction** Bench scales with "W" bases are IP66 washdown protected with IP66 stainless steel indicator, IP67 stainless steel load cell, 304 stainless steel column, pan and form-and-weld base frame. Bench scales with "H" bases are IP66 washdown protected with IP66 stainless steel indicator, IP67 aluminum load cell, 304 grade stainless steel platform with black polyurethane painted steel column and form-and-weld frame.
- Design Features** 150% overload capacity protection, NTEP Certified and Measurement Canada Approved



Model	Protection Rating	Capacity	Readability	Certified Readability	Platform Size	Item No.	Price USD
D51XW10WR3	IP66;NEMA 4X	25 lb / 10 kg	0.002 lb / 1 g	0.005 lb / 2 g	12 in x 12 in / 305 mm x 305 mm	80501214	1530
D51XW15HR1	Not Applicable	30 lb / 15 kg			14 in x 12 in / 355 mm x 305 mm	80500907	1580
D51XW25WR3	IP66;NEMA 4X	50 lb / 25 kg	0.005 lb / 2 g	0.01 lb / 5 g	12 in x 12 in / 305 mm x 305 mm	80501215	1556
D51XW30HR1	Not Applicable	60 lb / 30 kg			14 in x 12 in / 355 mm x 305 mm	80500908	1580
D51XW50WL4	IP66;NEMA 4X	100 lb / 50 kg	0.01 lb / 5 g	0.02 lb / 10 g	18 in x 18 in / 457 mm x 457 mm	80501216	2412
D51XW60HR1	Not Applicable	150 lb / 60 kg			14 in x 12 in / 355 mm x 305 mm	80500909	1580
D51XW60HL2			19.7 in x 15.7 in / 500 mm x 400 mm	80500910	1772		
D51XW100WL4	IP66;NEMA 4X	250 lb / 100 kg	0.02 lb / 10 g	0.1 lb / 50 g	18 in x 18 in / 457 mm x 457 mm	80501217	2412
D51XW100HL2	Not Applicable				19.7 in x 15.7 in / 500 mm x 400 mm	80500911	1772
D51XW150HX2		300 lb / 150 kg	0.05 lb / 20 g	0.2 lb / 100 g	21.7 in x 16.5 in / 550 mm x 420 mm	80500912	1945
D51XW250WX4	IP66;NEMA 4X	500 lb / 250 kg			24 in x 24 in / 610 mm x 610 mm	80501218	2776
D51XW300HX2	Not Applicable	600 lb / 300 kg			21.7 in x 16.5 in / 550 mm x 420 mm	80500913	2106

Accessories	Item No.	Price USD
Printer, Impact, SF40A, AM	30064203	798
Printer, Thermal, STP-103, US	80251992	622
Cable, RS232, CKW TxxXW	80500552	142
Relay Kit, AC, T51 T71	80500720	282
Relay Kit, DC, T51 T71	80500727	242
Wheel Kit, Defenders	30372146	105

Accessories	Item No.	Price USD
Rechargeable Battery Kit, T51 T71	80500729	182
RS422/485 Kit, T51 T71	80500731	79
RS232 Kit, T51 T71	80500733	59
Wall Mount Kit, SST, T51XW T71XW	80500735	65
Cable Kit, Loadcell Adapter, T51 T71	80500736	56
Software, Winwedge	80850080	437
Column Kit, Painted, Floor Stand	30047153	86
Column Kit, Stainless Steel, Floor Stand	30047154	204

Check-weighing, Display Hold, Dynamic Weighing, Parts Counting, Audible Alerts, Auto Shut-Off, Backlight, Battery Power, Environmental Filters, GLP Data Output, GMP/GLP, Time/Date, LED Check-weighing Indicator, Stability Indicator, NTEP Certified, Gross/Net/Tare, Totalization, Percent Weighing, Weighing, Level Indicator, Leveling Feet, Low Battery Indicator, Multi-Language, NEMA 4X IP66, Overload Protection, Overload/Underload Indicators, Rechargeable Battery, Software Lockout, Measurement Canada Approved

Defender® 5000

Multifunctional Bench Scales for Standard Industrial Applications

- Defender 5000 features software for parts counting, dynamic weighing, percent weighing, Checkweighing, display hold for large containers and can meet traceability requirements.
- Multiple connectivity capabilities include built-in RS232 bi-directional interface and external input as well as optional RS422/485, second RS232 and AC or DC relay.
- The durable Defender 5000 has a stainless steel platform, painted form-and-weld frame, column, and indicator bracket, IP67 load cell, as well as an ABS plastic indicator.



- Application** Weighing, Parts Counting, Percent Weighing, Checkweighing, Dynamic/Animal Weighing, Display Hold
- Display** Backlit liquid crystal display (LCD), 3 color Checkweighing LEDs
- Operation** Power cord (included) or 6 C (LR14) batteries (not included) or rechargeable battery (accessory sold separately)
- Communication** Easy access communication port including RS232 (included) and 2nd RS232 or RS422/RS485 (accessories sold separately). GLP/GMP data output with real-time clock.
- Construction** ABS plastic indicator with reversible rear cover and painted steel column and wall bracket, 304 grade stainless steel platform with black polyurethane painted steel form-and-weld frame, IP67 aluminum load cell, non-slip adjustable rubber feet
- Design Features** 150% overload capacity protection, NTEP Certified and Measurement Canada Approved

Model	Capacity	Readability	Certified Readability	Platform Size	Item No.	Price USD
D51P10QR1	25 lb / 10 kg	0.002 lb / 1 g	0.005 lb / 2 g	12 in x 12 in / 305 mm x 305 mm	80501154	1246
D51P15HR1	30 lb / 15 kg		0.01 lb / 5 g	14 in x 12 in / 355 mm x 305 mm	80500511	1142
D51P25QR1	50 lb / 25 kg	0.005 lb / 2 g	0.02 lb / 10 g	12 in x 12 in / 305 mm x 305 mm	80501155	1246
D51P30HR1	60 lb / 30 kg			14 in x 12 in / 355 mm x 305 mm	80500512	1142
D51P50QL2	100 lb / 50 kg	0.01 lb / 5 g	0.05 lb / 20 g	18 in x 18 in / 457 mm x 457 mm	80501156	1385
D51P60HR1	150 lb / 60 kg			14 in x 12 in / 355 mm x 305 mm	80500513	1142
D51P60HL2		250 lb / 100 kg	19.7 in x 15.7 in / 500 mm x 400 mm	80500514	1322	
D51P100QL2	0.02 lb / 10 g		18 in x 18 in / 457 mm x 457 mm	80501157	1385	
D51P100HL2	0.05 lb / 20 g	0.1 lb / 50 g	0.2 lb / 100 g	19.7 in x 15.7 in / 500 mm x 400 mm	80500515	1322
D51P150HX2	300 lb / 150 kg			0.02 lb / 10 g	21.7 in x 16.5 in / 550 mm x 420 mm	80251833
D51P250QX2	500 lb / 250 kg	0.05 lb / 20 g	0.2 lb / 100 g	24 in x 24 in / 610 mm x 610 mm	80501158	1989
D51P300HX2	600 lb / 300 kg			21.7 in x 16.5 in / 550 mm x 420 mm	80500516	1549

Accessories	Item No.	Price USD
Printer, Impact, SF40A, AM	30064203	798
Printer, Thermal, STP-103, US	80251992	622
Cable, RS232, IBM 9P, AV DV MB Ranger	80500525	155
Cable, SF42-AV DV MB Ranger	80500571	155
Interface Kit, RS232-USB	30304101	116
Interface Kit, RS232-Ethernet	30304102	116
Wheel Kit, Defenders	30372146	105

Accessories	Item No.	Price USD
Relay Kit, AC, T51 T71	80500720	282
Base Mount Kit, Painted, T51P T71P	80500722	45
Relay Kit, DC, T51 T71	80500727	242
Rechargeable Battery Kit, T51 T71	80500729	182
RS422/485 Kit, T51 T71	80500731	79
RS232 Kit, T51 T71	80500733	59
Software, Winwedge	80850080	437
Column Kit, Painted, Floor Stand	30047153	86
Column Kit, Stainless Steel, Floor Stand	30047154	204

Checkweighing	Display Hold	Dynamic Weighing	Parts Counting	Audible Alerts	Auto Shut-Off	Backlight	Battery Power	Environmental Filters	GLP Data Output	GMP/GLP	Time/Date	LED Checkweighing Indicator	NTEP Certified
Gross/Net/Tare	Totalization	Percent Weighing	Weighing	Level Indicator	Leveling Feet	Low Battery Indicator	Multi-Language	Overload Protection	Overload/Underload Indicators	Rechargeable Battery	Software Lockout	Stability Indicator	Measurement Canada Approved

Defender® 5000 Low Profile

Smart Functionality and Durability for Industrial Applications



- Applications including dynamic weighing and Checkweighing
- Defender 5000 offers multiple weighing modes including counting, percent weighing, dynamic/animal weighing and Checkweighing to meet the needs of various applications and industries.
- Includes an internal power supply with universal line cord or can be powered by 6 C (LR14) batteries for up to 80 hours.

- Application** Weighing, Dynamic Weighing, Parts Counting, Checkweighing, Percent Weighing, Display Hold
- Display** Liquid Crystal Display (LCD) with white LED backlight plus 3 color checkweigh LED
- Operation** Internal Universal Power Supply, 6 x C (LR14) Batteries (Not Included) or Optional Internal NiMH Rechargeable Battery
- Communication** RS232 (Included), 2nd RS232 (Available as an Accessory), RS422/485 (Available as an Accessory)
- Construction** ABS indicator, 304 stainless steel platform, black polyurethane painted steel form-and weld frame, IP67 aluminium load cell, base mount bracket included
- Design Features** Platform with 5 or 6 point overload stops for 150% safe overload protection, NTEP Certified and Measurement Canada Approved

Model	Capacity	Readability	Certified Readability	Platform Size	Item No.	Price USD
D51P10QR5	25 lb / 10 kg	0.002 lb / 1 g	0.005 lb / 2 g	12 in x 12 in / 305 mm x 305 mm	80501164	1246
D51P15HR5	30 lb / 15 kg			14 in x 12 in / 355 mm x 305 mm	80500799	1142
D51P25QR5	50 lb / 25 kg	0.005 lb / 2 g	0.01 lb / 5 g	12 in x 12 in / 305 mm x 305 mm	80501165	1246
D51P30HR5	60 lb / 30 kg			14 in x 12 in / 355 mm x 305 mm	80500800	1142
D51P50QL5	100 lb / 50 kg	0.01 lb / 5 g	0.02 lb / 10 g	18 in x 18 in / 457 mm x 457 mm	80501166	1385
D51P60HR5	150 lb / 60 kg			14 in x 12 in / 355 mm x 305 mm	80500801	1142
D51P60HL5			0.05 lb / 20 g	19.7 in x 15.7 in / 500 mm x 400 mm	80500802	1322
D51P100QL5	250 lb / 100 kg	0.02 lb / 10 g	0.1 lb / 50 g	18 in x 18 in / 457 mm x 457 mm	80501167	1385
D51P100HL5					19.7 in x 15.7 in / 500 mm x 400 mm	80500803
D51P150HX5	300 lb / 150 kg	0.05 lb / 20 g	0.2 lb / 100 g	21.7 in x 16.5 in / 550 mm x 420 mm	80500804	1392
D51P250QX5	500 lb / 250 kg			24 in x 24 in / 610 mm x 610 mm	80501168	1989
D51P300HX5	600 lb / 300 kg			21.7 in x 16.5 in / 550 mm x 420 mm	80500805	1549

Accessories	Item No.	Price USD
Printer, Impact, SF40A, AM	30064203	798
Printer, Thermal, STP-103, US	80251992	622
Cable, RS232, IBM 9P, AV DV MB Ranger	80500525	155
Relay Kit, AC, T51 T71	80500720	282
Base Mount Kit, Painted, T51P T71P	80500722	45

Accessories	Item No.	Price USD
Relay Kit, DC, T51 T71	80500727	242
Rechargeable Battery Kit, T51 T71	80500729	182
RS422/485 Kit, T51 T71	80500731	79
RS232 Kit, T51 T71	80500733	59
Software, Winwedge	80850080	437
Interface Kit, RS232-USB	30304101	116
Interface Kit, RS232-Ethernet	30304102	116



Defender® 3000 Washdown

Economical Stainless Steel Bench Scales for Basic Industrial Washdown Applications

- The NEMA 4X/IP65 stainless steel indicator can endure tough industrial elements while the internal rechargeable battery powers operation for 58 hours.
- The tough Defender 3000 has a stainless steel platform, stainless steel tubular frame, column and indicator bracket, IP67 stainless steel load cell.
- Simple operation, an easy-to-read display and even basic counting mode round out this industrial indicator, making it ideal for everyday basic industrial use.



30 lb model now available

- Application** Weighing, Parts Counting
- Display** Backlit liquid crystal display (LCD)
- Operation** Power cord (included) or rechargeable battery (included)
- Communication** Easy access communication port with RS232 interface (included)
- Construction** IP65 stainless steel indicator with hinged front cover, stainless steel column and wall bracket, 304 grade stainless steel platform with steel tubular frame, IP67 stainless steel load cell

Design Features 125% overload protection, NTEP Certified and Measurement Canada Approved

Model	Protection Rating	Capacity	Readability	Certified Readability	Platform Size	Item No.	Price USD
D32XW15VR	IP65 ; NEMA 4X	30 lb / 15 kg	0.005 lb / 2 g	0.01 lb / 5g	14 in x 12 in / 355 mm x 305 mm	30369114	1232
D32XW30VR		66 lb / 30 kg	0.01 lb / 5 g	0.02 lb / 10 g	14 in x 12 in / 355 mm x 305 mm	83999817	1232
D32XW60VR		132 lb / 60 kg	0.02 lb / 10 g	0.05 lb / 20 g	14 in x 12 in / 355 mm x 305 mm	83999818	1232
D32XW60VL		21.7 in x 16.5 in / 550 mm x 420 mm	83999819	1541			
D32XW150VL		330 lb / 150 kg	0.05 lb / 20 g	0.1 lb / 50 g	21.7 in x 16.5 in / 550 mm x 420 mm	83999820	1541
D32XW150VX		25.6 in x 19.7 in / 650 mm x 500 mm	83999821	2054			
D32XW300VX		660 lb / 300 kg	0.1 lb / 50 g	0.2 lb / 100 g	25.6 in x 19.7 in / 650 mm x 500 mm	83999822	2054

Accessories	Item No.	Price USD
Printer, Impact, SF40A, AM	30064203	798
Printer, Thermal, STP-103, US	80251992	622
Cable, RS232, CKW TxxXW	80500552	142
Software, Winwedge	80850080	437
Column Kit, Painted, Floor Stand	30047153	86
Column Kit, Stainless Steel, Floor Stand	30047154	204
Wheel Kit, Defenders	30372146	105

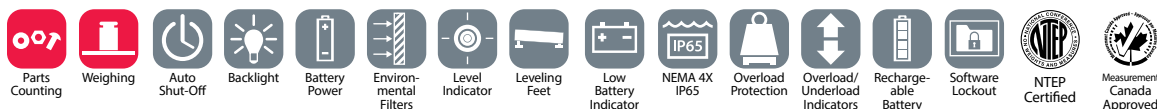

Defender® 3000

Economical Bench Scales for Basic Industrial Applications

- Defender 3000 is OIML approved, NTEP certified, and Measurement Canada approved for use in all legal-for-trade applications.
- The durable Defender 3000 has a 304 stainless steel platform, aluminum IP67 load cell, as well as a painted tubular steel frame, column and indicator bracket.
- The ultra-long-lasting internal rechargeable battery provides operation on a single charge for up to 120 hours, ensuring uninterrupted operation for five straight days.

- Application** Weighing, Parts Counting
- Display** Backlit liquid crystal display (LCD)
- Operation** AC adapter (included) or rechargeable battery (included)
- Communication** Easy access communication port with RS232 interface (included)
- Construction** ABS indicator with reversible rear cover, painted steel column and wall bracket, 304 grade stainless steel platform with painted steel tubular frame, IP67 aluminum load cell, self-adjusting stainless steel feet with removable rubber caps
- Design Features** 125% overload protection, NTEP Certified and Measurement Canada Approved



Model	Capacity	Readability	Certified Readability	Platform Size	Item No.	Price USD
D31P15BR	30 lb / 15 kg	0.005 lb / 2 g	0.01 lb / 5 g	14 in x 12 in / 355 mm x 305 mm	30369116	688
D31P30BR	66 lb / 30 kg	0.01 lb / 5 g	0.02 lb / 10 g	14 in x 12 in / 355 mm x 305 mm	83998111	688
D31P60BR	132 lb / 60 kg	0.02 lb / 10 g	0.05 lb / 20 g	14 in x 12 in / 355 mm x 305 mm	83998112	688
D31P60BL				21.7 in x 16.5 in / 550 mm x 420 mm	83998113	848
D31P150BL	330 lb / 150 kg	0.05 lb / 20 g	0.1 lb / 50 g	21.7 in x 16.5 in / 550 mm x 420 mm	83998114	848
D31P150BX				25.6 in x 19.7 in / 650 mm x 500 mm	83998115	903
D31P300BX	660 lb / 300 kg	0.1 lb / 50 g	0.2 lb / 100 g	25.6 in x 19.7 in / 650 mm x 500 mm	83998116	903

Accessories	Item No.	Price USD
Printer, Impact, SF40A, AM	30064203	798
Printer, Thermal, STP-103, US	80251992	622
Cable, RS232, IBM 9P, AV DV MB Ranger	80500525	155
Software, Winwedge	80850080	437
Column Kit, Painted, Floor Stand	30047153	86
Column Kit, Stainless Steel, Floor Stand	30047154	204
Interface Kit, RS232-USB	30304101	116
Interface Kit, RS232-Ethernet	30304102	116
Wheel Kit, Defenders	30372146	105
Handle Kit, D3K	30381321	80



ES Series

Multipurpose Low Profile Shipping Scale

- With different size low-profile platforms, there are ES scales that can accommodate weighing loads of different shapes and sizes.
- The three-way mounting bracket allows you to mount the indicator to the scale base, above the scale platform, or on any vertical surface for maximum flexibility.
- The sturdy and durable ES has a stainless steel platform and painted steel frame.

- Application** Weighing
- Display** Liquid crystal display (LCD)
- Operation** AC adapter (included) or 6 AA batteries (not included)
- Construction** ABS indicator, stainless steel platform, painted steel frame, 3 way mounting bracket
- Design Features** Auto-zero tracking, auto shut-off



Model	Capacity	Readability	Platform Size	Item No.	Price USD
ES6R	13 lb / 6 kg	0.005 lb / 0.002 kg	12.2 in x 10.8 in / 310 mm x 270 mm	71138830	730
ES30R	66 lb / 30 kg	0.05 lb / 0.01 kg	12.2 in x 10.8 in / 310 mm x 270 mm	71138831	730
ES50R	110 lb / 50 kg	0.05 lb / 0.02 kg	12.2 in x 10.8 in / 310 mm x 270 mm	71138832	730
ES50L			20.5 in x 15.7 in / 520 mm x 400 mm	71138833	775
ES100L	220 lb / 100 kg	0.1 lb / 0.05 kg	20.5 in x 15.7 in / 520 mm x 400 mm	71138834	775
ES200L	440 lb / 200 kg	0.2 lb / 0.1 kg	20.5 in x 15.7 in / 520 mm x 400 mm	71138835	775

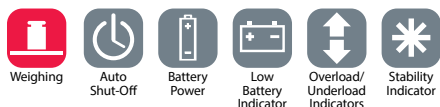

Bench Scales

SD Series

Rugged Economical Shipping Scales

- The SD is available in three capacities of 35 kg, 75 kg and 200 kg and two platform sizes to meet the weighing needs of jobs of different physical sizes and capacities.
- SD's painted steel platform and frame provides sturdy support for all materials placed on the platform.
- SD not only provides accurate general weight determination but also has the software to support dynamic/animal weighing and display hold.
- New WeighAlert mode flashes weight display when weight on platform is greater than 70lb and less than 151lb, alerting user that package is too heavy for USPS service but below Less-Than-Truckload (LTL) limit for shipping.



WeighAlert mode
now available



- Application** Weighing, Animal/Dynamic Weighing, Display Hold
- Display** Liquid crystal display (LCD)
- Operation** AC adapter (included) or 3 C (LR14) batteries (not included)
- Construction** ABS indicator, painted steel base, raised, embossed tread platform (non-L models), rubber feet (adjustable on L models), mounting brackets, transportation handle, extendable coiled cable
- Design Features** Transportation handle on packaging (non-L models)

Model	Capacity	Readability	Platform Size	Item No.	Price USD
SD35	77 lb / 35 kg	0.05 lb / 0.02 kg	12.4 in x 11 in / 316 mm x 280 mm	83998234	203
SD75	165 lb / 75 kg	0.1 lb / 0.05 kg	12.4 in x 11 in / 316 mm x 280 mm	83998235	217
SD75L			20.5 in x 15.7 in / 520 mm x 400 mm	83998236	356
SD200	440 lb / 200 kg	0.2 lb / 0.1 kg	12.4 in x 11 in / 316 mm x 280 mm	83998237	257
SD200L			20.5 in x 15.7 in / 520 mm x 400 mm	83998238	388

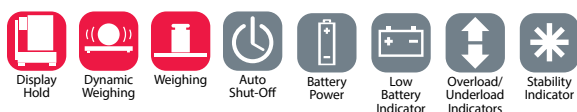

Ranger® 7000

Simplifying Even the Most Complex Industrial Applications

- Ten advanced modes with up to 2,000 item library simplify complex applications and minimize the need for manual calculations and it can also control peripheral devices and/or a scale platform with option kit.
- With one second stabilization time, up to 350,000d display resolution and Legal-for-Trade certifications, Ranger 7000's precision cannot be matched by any scale in its class.
- Ranger 7000 was developed to thrive in rugged and harsh industrial environments. This modular scale was built with IP54 metal housing and sealed metal indicator to ensure durability.



Now with added Counting Features

- Application** Weighing, Parts Counting with Auto Optimization, Percent Weighing, Advanced Checkweighing, Animal/Dynamic Weighing, Display Hold, Filling, Formulation, Differential Weighing, Density Determination, Sieve Analysis
- Display** 4.3" (109 mm) Full-color WQVGA graphic display with user-controlled brightness
- Operation** AC power (included) or rechargeable battery (accessory sold separately)
- Communication** Easy access communication port including standard USB and RS232 (included) and an optional third port of RS232 or Ethernet (accessories sold separately). GLP/ GMP Data Output with Real Time Clock. Data Transfer Function.
- Construction** Modular design, die-cast housing, removable stainless steel platform, integral weigh below hook, menu lock switch, level indicator
- Design Features** Checkweighing lights with selectable operation and audible signal settings, several selectable operating languages, selectable environmental and auto-print settings, stability indicator, overload/underload indicators, selectable brightness settings, auto-; Checkweighing lights with selectable operation and audible signal settings, several selectable operating languages, selectable environmental and auto-print settings, stability indicator, overload/underload indicators, selectable brightness settings, auto-dim, auto-sleep, auto tare, chain tare.

Model	InCal™	Capacity	Readability	Certified Readability	Platform Size	Item No.	Price USD
R71MD3		6 lb / 3 kg	0.0001 lb / 0.05 g	0.001 lb / 0.5 g	11 in x 11 in / 280 mm x 280 mm	30070289	1561
R71MD6		15 lb / 6 kg	0.0002 lb / 0.1 g	0.002 lb / 1 g	11 in x 11 in / 280 mm x 280 mm	30070310	1561
R71MD15		30 lb / 15 kg	0.0005 lb / 0.2 g	0.005 lb / 2 g	12.2 in x 14.8 in / 311 mm x 377 mm	30070311	1561
R71MD35		70 lb / 35 kg	0.001 lb / 0.5 g	0.01 lb / 5 g	12.2 in x 14.8 in / 311 mm x 377 mm	30070312	1561
R71MD60		150 lb / 60 kg	0.002 lb / 1 g	0.02 lb / 10 g	12.2 in x 14.8 in / 311 mm x 377 mm	30212873	1561

Model	InCal™	Capacity	Readability	Certified Readability	Platform Size	Item No.	Price USD
R71MHD3	•	6 lb / 3 kg	0.00002 lb / 0.01 g	0.0002 lb / 0.1 g	9.4 in x 9.4 in / 240 mm x 240 mm	30088840	2440
R71MHD6	•	15 lb / 6 kg	0.00005 lb / 0.02 g	0.0005 lb / 0.2 g	9.4 in x 9.4 in / 240 mm x 240 mm	30088841	2706
R71MHD15	•	30 lb / 15 kg	0.0002 lb / 0.1 g	0.002 lb / 1 g	12.2 in x 14.8 in / 311 mm x 377 mm	30088842	3602
R71MHD35	•	70 lb / 35 kg	0.0002 lb / 0.1 g	0.002 lb / 1 g	12.2 in x 14.8 in / 311 mm x 377 mm	30088843	4345

Accessories	Item No.	Price USD
Ethernet Kit, R31 RC31 R71 V71	30037447	122
RS232 Kit, R31 RC31 R71 V71	30037448	122
Rechargeable Battery, EX-HiCap R71	30041295	311
Printer, Impact, SF40A, AM	30064203	798
Column Kit, Painted, R71	30095408	122
PCBA Kit, 2nd Platform, R71	30097590	123

Accessories	Item No.	Price USD
Discrete I/O Kit, 2-In/4-Out, R71	30097591	122
Cable, Extension, 9m, R71	30101495	86
PCBA Kit, Alibi Memory, R71 T71	80500503	97
Accessory, In Use Cover, R71	30135320	35
Cable, RS232, IBM 9P, AV DV MB Ranger	80500525	155
Software, Winwedge	80850080	437

* Not in parts counting mode

Accumulation	Checkweighing	Density Determination	Differential Weighing	Display Hold	Dynamic Weighing	Filling	Audible Alerts	Battery Power	Environmental Filters	External Analog Base Input	GLP Data Output	GMP/GLP	Internal Calibration	LED Checkweighing Indicator	NTEP Certified *
Formulation	Gross/Net/Tare	Parts Counting	Percent Weighing	Statistics	Totalization	Weighing	Level Indicator	Leveling Feet	Overload/Underload Indicators	Rechargeable Battery	Stability Indicator	Time/Date	Weigh Below Hook	Measurement Canada Approved *	

Counting Scales

Ranger® Count 4000

The Best Value for Durable Industrial Counting

- Sturdy metal housing and slip-resistant rubber feet provide the protection and stability necessary for tough industrial weighing while extending the scale's usable life.
- Accurate weighing and counting performance is assured through Ranger Count 4000's 1:1,500,000 internal counting resolution, 30 item library and auto-optimization software that reduces errors and ensures accuracy.
- The combination of SmarText™ software, a centrally located count display and dedicated Sample & Tare keys make Ranger Count 4000 very easy to operate.



- Application** Weighing, Parts Counting with Auto Optimization, Checkweighing, Accumulation
- Display** 3 window backlit liquid crystal display (LCD), 3 color Checkweighing LEDs
- Operation** AC power (included) or rechargeable battery (included)
- Communication** Easy access communication port including standard RS232 (included) and second RS232, USB or Ethernet (accessories sold separately)
- Construction** Rugged Cast Aluminum Housing, Stainless Steel Platform
- Design Features** Cast Aluminum Housing, stainless steel platform, sealed front panel, menu lockswitch, up front level indicator, adjustable leveling feet, selectable environmental and auto-print settings, stability indicator, overload and underload indicators, low battery indicator, auto shut-off, auto tare

Model	Capacity	Readability	Certified Readability	Platform Size	Item No.	Price USD
RC41M3	6 lb / 3 g	0.0002 lb / 0.1 g	0.002 lb / 1 g	8.9 in x 11.8 in / 225 mm x 300 mm	30236779	815
RC41M6	15 lb / 6 kg	0.0005 lb / 0.2 g	0.005 lb / 2 g	8.9 in x 11.8 in / 225 mm x 300 mm	30236940	815
RC41M15	30 lb / 15 kg	0.001 lb / 0.5 g	0.01 lb / 5 g	8.9 in x 11.8 in / 225 mm x 300 mm	30236941	815
RC41M30	60 lb / 30 kg	0.002 lb / 1 g	0.02 lb / 10 g	8.9 in x 11.8 in / 225 mm x 300 mm	30236942	815

Accessories	Item No.	Price USD
PCBA Kit, 2nd Platform, RC31 RC41	30037446	122
Ethernet Kit, R31 RC31 R71 V71 RC41	30037447	122
RS232 Kit, R31 RC31 R71 V71 RC41	30037448	122
USB Kit, R31 RC31 V71 RC41	30037449	122
In Use Cover	30240697	28

Accessories	Item No.	Price USD
Printer, Impact, SF40A, AM	30064203	798
Printer, Thermal, STP-103, US	80251992	622
Cable, RS232, IBM 9P, AV DV MB Ranger	80500525	155
Software, Winwedge	80850080	437

* Not in parts counting mode

Ranger® Count 3000

Multipurpose Compact Counting Scales for Basic Industrial Applications

- Accurate weighing and counting performance is assured through Ranger Count 3000's high resolution, 30 item library function and auto-optimization software that reduces errors.
- The 3 backlit LCD displays, including a centrally located count display, along with an easy-to-navigate menu, make Ranger Count 3000 easy to use in multi-step counting operations.
- Ranger Count 3000 produces accurate results within one second and virtually eliminates your wait time and allows you to move at a pace determined by you, not your weighing equipment.



- Application** Weighing, Parts Counting with Auto Optimization, Checkweighing, Accumulation
- Display** 3 window backlit liquid crystal display (LCD), 3 color Checkweighing LEDs
- Operation** AC power (included) or rechargeable battery (included)
- Communication** Easy access communication port including standard RS232 (included) and second RS232, USB or Ethernet (accessories sold separately)
- Construction** ABS housing, stainless steel platform, numeric keypad, menu lock switch, up front level indicator, transportation handle
- Design Features** 30 item library, 210 hours of battery life, 3 LED Checkweighing lights with selectable operation and audible signal settings, auto tare, selectable environmental and auto-print settings, auto shut-off, optional 2nd scale input

Model	Capacity	Readability	Certified Readability	Platform Size	Item No.	Price USD
RC31P1502	3 lb / 1.5 kg	0.0001 lb / 0.05 g	0.001 lb / 0.5 g	8.9 in x 11.8 in / 225 mm x 300 mm	30031787	689
RC31P3	6 lb / 3 kg	0.0002 lb / 0.1 g	0.002 lb / 1 g	8.9 in x 11.8 in / 225 mm x 300 mm	30031788	689
RC31P6	15 lb / 6 kg	0.0005 lb / 0.2 g	0.005 lb / 2 g	8.9 in x 11.8 in / 225 mm x 300 mm	30031789	689
RC31P15	30 lb / 15 kg	0.001 lb / 0.5 g	0.01 lb / 5 g	8.9 in x 11.8 in / 225 mm x 300 mm	30031790	689
RC31P30	60 lb / 30 kg	0.002 lb / 1 g	0.02 lb / 10 g	8.9 in x 11.8 in / 225 mm x 300 mm	30031791	689

Accessories	Item No.	Price USD
PCBA Kit, 2nd Platform, RC31	30037446	122
Ethernet Kit, R31 RC31 R71 V71	30037447	122
RS232 Kit, R31 RC31 R71 V71	30037448	122
USB Kit, R31 RC31 V71	30037449	122
Hook, R21 RC21 R31 RC31 V71	30037450	87

Accessories	Item No.	Price USD
In-Use-Cover, R21 RC21 R31 RC31	30037451	30
Printer, Impact, SF40A, AM	30064203	798
Printer, Thermal, STP-103, US	80251992	622
Cable, RS232, IBM 9P, AV DV MB Ranger	80500525	155
Carrying Case, TR TC R31 TC31 RC31	80850084	304
Software, Winwedge	80850080	437

* Not in parts counting mode

Compact Bench Scales

Ranger® 7000

Simplifying Even the Most Complex Industrial Applications

- Ten advanced modes with up to 2,000 item library simplify complex applications and minimize the need for manual calculations and it can also control peripheral devices and/or a scale platform with option kit.
- With one second stabilization time, up to 350,000d display resolution and Legal-for-Trade certifications, Ranger 7000's precision cannot be matched by any scale in its class.
- Ranger 7000 was developed to thrive in rugged and harsh industrial environments. This modular scale was built with IP54 metal housing and sealed metal indicator to ensure durability.

Application Weighing, Parts Counting with Auto Optimization, Percent Weighing, Advanced Checkweighing, Animal/Dynamic Weighing, Display Hold, Filling, Formulation, Differential Weighing, Density Determination, Sieve Analysis Mode with customizable printout

Display 4.3" (109 mm) Full-color WQVGA graphic display with user-controlled brightness

Operation AC power (included) or rechargeable battery (accessory sold separately)

Communication Easy access communication port including standard USB and RS232 (included) and an optional third port of RS232 or Ethernet (accessories sold separately). GLP/ GMP Data Output with Real Time Clock. Data Transfer Function.

Construction Modular design, die-cast housing, removable stainless steel platform, integral weigh below hook, menu lock switch, level indicator

Design Features Checkweighing lights with selectable operation and audible signal settings, several selectable operating languages, selectable environmental and auto-print settings, stability indicator, overload/underload indicators, selectable brightness settings, auto-; Checkweighing lights with selectable operation and audible signal settings, several selectable operating languages, selectable environmental and auto-print settings, stability indicator, overload/underload indicators, selectable brightness settings, auto-dim, auto-sleep, auto tare, chain tare, NTEP Certified and Measurement Canada Approved



Now with Sieve Analysis Mode



Model	InCal™	Capacity	Readability	Certified Readability	Platform Size	Item No.	Price USD
R71MD3		6 lb / 3 kg	0.0001 lb / 0.05 g	0.001 lb / 0.5 g	11 in x 11 in / 280 mm x 280 mm	30070289	1561
R71MD6		15 lb / 6 kg	0.0002 lb / 0.1 g	0.002 lb / 1 g	11 in x 11 in / 280 mm x 280 mm	30070310	1561
R71MD15		30 lb / 15 kg	0.0005 lb / 0.2 g	0.005 lb / 2 g	12.2 in x 14.8 in / 311 mm x 377 mm	30070311	1561
R71MD35		70 lb / 35 kg	0.001 lb / 0.5 g	0.01 lb / 5 g	12.2 in x 14.8 in / 311 mm x 377 mm	30070312	1561
R71MD60		150 lb / 60 kg	0.002 lb / 1 g	0.02 lb / 10 g	12.2 in x 14.8 in / 311 mm x 377 mm	30212873	1561

Model	InCal™	Capacity	Readability	Certified Readability	Platform Size	Item No.	Price USD
R71MHD3	•	6 lb / 3 kg	0.00002 lb / 0.01 g	0.0002 lb / 0.1 g	9.4 in x 9.4 in / 240 mm x 240 mm	30088840	2440
R71MHD6	•	15 lb / 6 kg	0.00005 lb / 0.02 g	0.0005 lb / 0.2 g	9.4 in x 9.4 in / 240 mm x 240 mm	30088841	2706
R71MHD15	•	30 lb / 15 kg	0.0002 lb / 0.1 g	0.002 lb / 1 g	12.2 in x 14.8 in / 311 mm x 377 mm	30088842	3602
R71MHD35	•	70 lb / 35 kg	0.0002 lb / 0.1 g	0.002 lb / 1 g	12.2 in x 14.8 in / 311 mm x 377 mm	30088843	4345

Accessories	Item No.	Price USD
Ethernet Kit, R31 RC31 R71 V71	30037447	122
RS232 Kit, R31 RC31 R71 V71	30037448	122
Rechargeable Battery, EX-HiCap R71	30041295	311
Printer, Impact, SF40A, AM	30064203	798
Column Kit, Painted, R71	30095408	122
PCBA Kit, 2nd Platform, R71	30097590	123

Accessories	Item No.	Price USD
Discrete I/O Kit, 2-In/4-Out, R71	30097591	122
Cable, Extension, 9m, R71	30101495	86
PCBA Kit, Alibi Memory, R71 T71	80500503	97
Accessory, In Use Cover, R71	30135320	35
Cable, RS232, IBM 9P, AV DV MB Ranger	80500525	155
Software, Winwedge	80850080	437

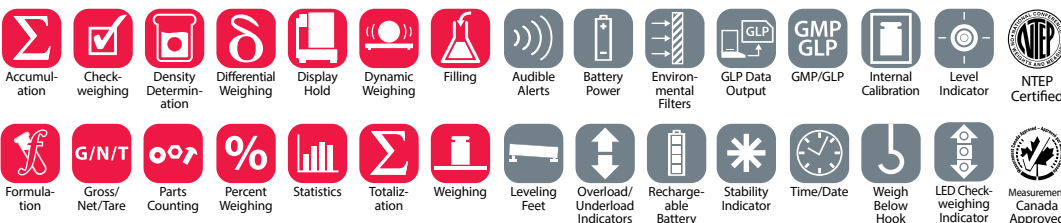

Ranger® 4000

The Best Value for Durable Industrial Weighing

- Sturdy metal housing and slip-resistant rubber feet provide the protection and stability necessary for tough industrial weighing, while extending the product's usable life.
- The largest, white LED display on any scale in its class, combined with Checkweighing LEDs and audible indicators, make Ranger 4000 highly functional in loud and dim industrial settings.
- Spend time on your work, not on mastering the technicalities of the scale. SmarText™ software makes scale setup and use very simple.



- Application** Weighing, Parts Counting, Checkweighing, Percent Weighing, Animal/Dynamic Weighing, Display Hold, Accumulation
- Display** Light-emitting diode display (LED), 3 color Checkweighing LEDs
- Operation** AC power (included) or rechargeable battery (included)
- Communication** Easy access communication port including standard RS232 (included) and second RS232, USB or Ethernet (accessories sold separately)
- Construction** Rugged Cast Aluminum Housing, Stainless Steel Platform
- Design Features** Cast aluminum housing, stainless steel platform, integral weigh-below hook, sealed front panel, menu lock switch, up front level indicator, adjustable leveling feet, selectable environmental and auto-print settings, stability indicator, overload and underload indicators, low battery indicator, auto shut-off, auto tare, NTEP Certified and Measurement Canada Approved

Model	Capacity	Readability	Certified Readability	Platform Size	Item No.	Price USD
R41ME3	6 lb / 3 kg	0.0002 lb / 0.1 g	0.002 lb / 1 g	8.9 in x 11.8 in / 225 mm x 300 mm	30236775	775
R41ME6	15 lb / 6 kg	0.0005 lb / 0.2 g	0.005 lb / 2 g	8.9 in x 11.8 in / 225 mm x 300 mm	30236776	775
R41ME15	30 lb / 15 kg	0.001 lb / 0.5 g	0.01 lb / 5 g	8.9 in x 11.8 in / 225 mm x 300 mm	30236777	775
R41ME30	60 lb / 30 kg	0.002 lb / 1 g	0.02 lb / 10 g	8.9 in x 11.8 in / 225 mm x 300 mm	30236778	775

Accessories	Item No.	Price USD
PCBA Kit, 2nd Platform, RC31 R41	30037446	122
Ethernet Kit, R31 RC31 R71 V71 R41	30037447	122
RS232 Kit, R31 RC31 R71 V71 R41	30037448	122
USB Kit, R31 RC31 V71 R41	30037449	122
In Use Cover	30240697	28

Accessories	Item No.	Price USD
Printer, Impact, SF40A, AM	30064203	798
Printer, Thermal, STP-103, US	80251992	622
Cable, RS232, IBM 9P, AV DV MB Ranger	80500525	155
Software, Winwedge	80850080	437

Accumulation	Checkweighing	Display Hold	Dynamic Weighing	Audible Alerts	Auto Shut-Off	Backlight	Battery Power	Environmental Filters	External Analog Base Input	Level Indicator	NTEP Certified
Gross/Net/Tare	Parts Counting	Percent Weighing	Weighing	Leveling Feet	Low Battery Indicator	Overload/Underload Indicators	Rechargeable Battery	Stability Indicator	Weigh Below Hook	LED Checkweighing Indicator	Measurement Canada Approved

Compact Bench Scales

Ranger® 3000

Multipurpose Compact Bench Scales for Basic Industrial Applications

- Ranger 3000 has the largest display in its class and is equipped with Checkweighing LEDs and backlit LCD displays which make it functional in almost any working condition.
- The most user friendly scale on the market with easy setup that ensures your valuable time is not wasted and you're working as proficiently as possible.
- Ranger 3000 produces accurate results within one second, virtually eliminates your wait time, and allows you to move at a pace determined by you, not your weighing equipment.



- Application** Weighing, Parts Counting, Checkweighing, Percent Weighing, Animal/Dynamic Weighing, Display Hold, Accumulation
- Display** Backlit liquid crystal display (LCD), 3 color Checkweighing LEDs
- Operation** AC power (included) or rechargeable battery (included)
- Communication** Easy access communication port including standard RS232 (included) and second RS232, USB or Ethernet (accessories sold separately)
- Construction** ABS housing, stainless steel platform, menu lock switch, up-front level indicator, integral weigh-below hook, transportation handle
- Design Features** 210 hours of battery life, 3 LED Checkweighing lights with selectable operation and audible signal settings, selectable environmental and auto-print settings, auto shut-off, auto tare, NTEP Certified and Measurement Canada Approved

Model	Capacity	Readability	Certified Readability	Platform Size	Item No.	Price USD
R31P1502	3 lb / 1.5 kg	0.0001 lb / 0.05 g	0.001 lb / 0.5 g	8.9 in x 11.8 in / 225 mm x 300 mm	30031707	561
R31P3	6 lb / 3 kg	0.0002 lb / 0.1 g	0.002 lb / 1 g	8.9 in x 11.8 in / 225 mm x 300 mm	30031708	561
R31P6	15 lb / 6 kg	0.0005 lb / 0.2 g	0.005 lb / 2 g	8.9 in x 11.8 in / 225 mm x 300 mm	30031709	561
R31P15	30 lb / 15 kg	0.001 lb / 0.5 g	0.01 lb / 5 g	8.9 in x 11.8 in / 225 mm x 300 mm	30031710	561
R31P30	60 lb / 30 kg	0.002 lb / 1 g	0.02 lb / 10 g	8.9 in x 11.8 in / 225 mm x 300 mm	30031711	561

Accessories	Item No.	Price USD
Ethernet Kit, R31 RC31 R71 V71 R41	30037447	122
RS232 Kit, R31 RC31 R71 V71 R41	30037448	122
USB Kit, R31 RC31 V71 R41	30037449	122
In-Use-Cover, R21 RC21 R31 RC31 R41	30037451	30

Accessories	Item No.	Price USD
Printer, Impact, SF40A, AM	30064203	798
Printer, Thermal, STP-103, US	80251992	622
Cable, RS232, IBM 9P, AV DV MB Ranger	80500525	155
Carrying Case, TR TC R31 TC31 V71	80850084	304
Software, Winwedge	80850080	437

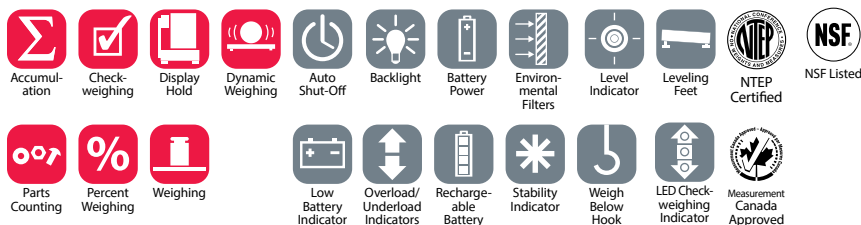

Valor® 7000

The Best Compact Food Scale in its Class

- Front and rear touchless sensors allow Valor 7000 to operate certain functions and its food-safe design is NSF Certified, USDA-AMS Accepted, and supports HACCP-Certified systems.
- Large front and rear displays with backlights and Checkweighing LEDs are among Valor 7000's features that enhance the user experience and allow two operators to share one scale.
- Valor 7000 produces accurate results within one second to virtually eliminate your wait time and allows you to move at a pace determined by you, not your weighing equipment.



- Application** Weighing, Percent Weighing, Checkweighing, Accumulation
- Display** Dual backlit liquid crystal displays (LCD)
- Operation** AC power (included) or rechargeable battery (included)
- Communication** RS232 (included) or second RS232 or USB or Ethernet (accessories sold separately)
- Construction** ABS housing, stainless steel platform, touchless sensor, transportation handle, menu lock switch, up front level indicator
- Design Features** 210 hours of battery life, 3 LED Checkweighing lights with selectable operation and audible signal settings, selectable environmental and auto-print settings, auto shut-off, auto tare, NTEP Certified and Measurement Canada Approved

Model	Capacity	Readability	Certified Readability	Platform Size	Item No.	Price USD
V71P1502T	3 lb / 1.5 kg	0.0001 lb / 0.05 g	0.001 lb / 0.5 g	8.9 in x 11.8 in / 225 mm x 300 mm	30031827	593
V71P3T	6 lb / 3 kg	0.0002 lb / 0.1 g	0.002 lb / 1 g	8.9 in x 11.8 in / 225 mm x 300 mm	30031828	593
V71P6T	15 lb / 6 kg	0.0005 lb / 0.2 g	0.005 lb / 2 g	8.9 in x 11.8 in / 225 mm x 300 mm	30031829	593
V71P15T	30 lb / 15 kg	0.001 lb / 0.5 g	0.01 lb / 5 g	8.9 in x 11.8 in / 225 mm x 300 mm	30031830	593
V71P30T	60 lb / 30 kg	0.002 lb / 1 g	0.02 lb / 10 g	8.9 in x 11.8 in / 225 mm x 300 mm	30031831	593

Accessories	Item No.	Price USD
In-Use-Cover, V71	30037445	30
Ethernet Kit, R31 RC31 R71 V71	30037447	122
RS232 Kit, R31 RC31 R71 V71	30037448	122
USB Kit, R31 RC31 V71	30037449	122
Hook, R21 RC21 R31 RC31 V71	30037450	87

Accessories	Item No.	Price USD
In-Use-Cover, Set(10), V71	30037469	61
Printer, Impact, SF40A, AM	30064203	798
Cable, RS232, IBM 9P, AV DV MB Ranger	80500525	155
Carrying Case, TR TC R31 TC31 V71	80850084	304
Software, Winwedge	80850080	437

Accumulation
 Checkweighing
 Auto Shut-Off
 Backlight
 Battery Power
 Environmental Filters
 Level Indicator
 Leveling Feet
 NTEP Certified
 NSF Listed

Percent Weighing
 Weighing
 Low Battery Indicator
 Overload/Underload Indicators
 Rechargeable Battery
 Stability Indicator
 Weigh Below Hook
 LED Checkweighing Indicator
 Measurement Canada Approved
 USDA-AMS Accepted

Compact Bench Scales

FD Series

Speed, Durability and Cleanliness Designed for Food Service Use



- The fully stainless steel FD is NSF Certified and supports HACCP-Certified systems helping to ensure the integrity and safety of the weighing of all food products.
- With software for general weighing, percent weighing and Checkweighing, the FD can be used for a variety of food weighing needs.
- The 120-hour internal rechargeable battery will help ensure that your scale is up and running when you need it, even during long shifts.

- Application** Weighing, Percent Weighing, Checkweighing
- Display** Backlit liquid crystal display (LCD)
- Operation** AC adapter (included) or rechargeable battery (included)
- Construction** Stainless steel housing and platform, up-front level indicator
- Design Features** Manual or automatic tare, audible buzzer alerts, LED Checkweighing lights, foot switch (optional), NTEP Certified and Measurement Canada Approved

Model	Capacity	Readability	Certified Readability	Platform Size	Item No.	Price USD
FD3H	6 lb / 3 kg	0.0002 lb / 0.1 g	—	8.2 in x 8.2 in / 209 mm x 209 mm	83998147	815
FD6H	15 lb / 6 kg	0.001 lb / 0.2 g		8.2 in x 8.2 in / 209 mm x 209 mm	83998148	815
FD15H	30 lb / 15 kg	0.001 lb / 1 g		8.2 in x 8.2 in / 209 mm x 209 mm	83998149	815

Approved Model*	Capacity	Readability	Certified Readability	Platform Size	Item No.	Price USD
FD3	6 lb / 3 kg	0.001 lb / 0.5 g	0.002 lb / 1 g	8.2 in x 8.2 in / 209 mm x 209 mm	83998117	735
FD6	15 lb / 6 kg	0.002 lb / 1 g	0.005 lb / 2 g	8.2 in x 8.2 in / 209 mm x 209 mm	83998118	735
FD15	30 lb / 15 kg	0.005 lb / 2 g	0.01 lb / 5 g	8.2 in x 8.2 in / 209 mm x 209 mm	83998119	735

Accessories	Item No.	Price USD
In-Use-Cover, FD V51	80251140	32
Pan, SST, Flat, FD V51	80251141	48
Carrying Case, FD V51	80251394	103



Valor® 4000

Legal-for-Trade Food Scale That Enhances Efficiency in Harsh Environments

- With Legal-for-Trade certifications and a food-safe design that is NSF Certified, USDA-AMS Accepted and supports HACCP Certified systems, Valor 4000 is ready for demanding applications.
- Touchless sensors combined with a half second stabilization time, as well as Checkweighing and percent weighing modes, increase productivity without sacrificing accuracy.
- Safe to use in wet environments, Valor 4000's flow-thru design ensures the scale remains clean and operational, and its knife resistant keypad makes the scale more durable.

- Application** Weighing, Percent Weighing, Checkweighing, Accumulation
- Display** Dual light emitting diode (LED) displays
- Operation** AC adapter (included) or rechargeable battery (included)
- Construction** ABS housing with stainless steel platform (PW), stainless steel housing and platform (XW), illuminated up-front level indicator, rear touchless sensor
- Design Features** Auto-close power jack cover, menu and mode setup navigation prompts on keys, transportation handle, NTEP Certified and Measurement Canada Approved



XW Models Feature Stainless Steel Top Housing

Model	Protection Rating	Capacity	Readability	Certified Readability	Platform Size	Item No.	Price USD
V41XWE1501T	IPX8	3 lb / 1.5 kg	0.0005 lb / 0.2 g	0.001 lb / 0.5 g	7.5 in x 9.5 in / 190 mm x 242 mm	30035444	514
V41XWE3T		6 lb / 3 kg	0.001 lb / 0.5 g	0.002 lb / 1 g	7.5 in x 9.5 in / 190 mm x 242 mm	30035445	514
V41XWE6T		15 lb / 6 kg	0.002 lb / 1 g	0.005 lb / 2 g	7.5 in x 9.5 in / 190 mm x 242 mm	30035446	514
V41XWE15T		30 lb / 15 kg	0.005 lb / 2 g	0.01 lb / 5 g	7.5 in x 9.5 in / 190 mm x 242 mm	30035447	514

PW Models Feature ABS Housing

Model	Protection Rating	Capacity	Readability	Certified Readability	Platform Size	Item No.	Price USD
V41PWE1501T	IPX8	3 lb / 1.5 kg	0.0005 lb / 0.2 g	0.001 lb / 0.5 g	7.5 in x 9.5 in / 190 mm x 242 mm	30035434	438
V41PWE3T		6 lb / 3 kg	0.001 lb / 0.5 g	0.002 lb / 1 g	7.5 in x 9.5 in / 190 mm x 242 mm	30035435	438
V41PWE6T		15 lb / 6 kg	0.002 lb / 1 g	0.005 lb / 2 g	7.5 in x 9.5 in / 190 mm x 242 mm	30035436	438
V41PWE15T		30 lb / 15 kg	0.005 lb / 2 g	0.01 lb / 5 g	7.5 in x 9.5 in / 190 mm x 242 mm	30035437	438

Accessories	Item No.	Price USD
Large Pan, 11.8 x 8.8 in V22 V41	30251753	46



Compact Bench Scales

Valor® 3000

Rugged, Full Stainless Steel Design in a High Performance Portable Scale

- The stainless steel Valor 3000 Xtreme is NSF Certified and supports HACCP-Certified systems helping to ensure the integrity and safety of all food products weighed on the scale.
- The compact Valor 3000 Xtreme requires minimal counter space and offers resolutions up to 40,000d and 0.01 g, providing precise measurements in demanding environments.
- With software for general weighing, percent weighing and specific gravity, the Valor 3000 can be used for a variety of food weighing and measurement needs.

- Application** Weighing, Percent Weighing, Specific Gravity
- Display** Backlit liquid crystal display (LCD)
- Operation** AC adapter (included) or 4 C (LR14) batteries (not included)
- Construction** Stainless steel housing and platform, up-front level indicator, load cell lock
- Design Features** Selectable environmental settings, auto tare, auto shut-off, selectable power-up unit, optional food accessories, NTEP Certified models available



Model	Protection Rating	Capacity	Readability	Certified Readability	Platform Size	Item No.	Price USD
V31XH202	Not Applicable	0.441 lb / 200 g	0.00005 lb / 0.01 g	—	Ø 4.7 in / Ø 120 mm	83998130	647
V31XW301	IP65; NEMA 4X	0.662 lb / 300 g	0.0005 lb / 0.1 g		6.2 in x 5.7 in / 158 mm x 146 mm	83998134	509
V31XH402	Not Applicable	0.88 lb / 400 g	0.00005 lb / 0.01 g		Ø 4.7 in / Ø 120 mm	83998178	837
V31X501		1.1 lb / 500 g	0.0005 lb / 0.1 g		Ø 4.7 in / Ø 120 mm	83998176	474
V31XH2		4.4 lb / 2 kg			6.2 in x 5.7 in / 158 mm x 146 mm	83998131	647
V31X3		6 lb / 3 kg	0.005 lb / 1 g		6.2 in x 5.7 in / 158 mm x 146 mm	83998132	430
V31XH4		8.8 lb / 4 kg	0.0005 lb / 0.1 g		6.2 in x 5.7 in / 158 mm x 146 mm	83998177	889
V31X6		15 lb / 6 kg	0.005 lb / 1 g		6.2 in x 5.7 in / 158 mm x 146 mm	83998133	430

Approved Model*	Protection Rating	Capacity	Readability	Certified Readability	Platform Size	Item No.	Price USD
V31XW3	IP65; NEMA 4X	6 lb / 3 kg	0.005 lb / 0.5 g	0.005 lb / 1 g	6.2 in x 5.7 in / 158 mm x 146 mm	83998135	509
V31X3N	Not Applicable				6.2 in x 5.7 in / 158 mm x 146 mm	83999992	502
V31X6N	IP65; NEMA 4X	13.23 lb / 6 kg	0.005 lb / 1 g	0.005 lb / 2 g	6.2 in x 5.7 in / 158 mm x 146 mm	83999996	492
V31XW6		15 lb / 6 kg			6.2 in x 5.7 in / 158 mm x 146 mm	83998136	509

Accessories	Item No.	Price USD
Large Pan, SST, Sandwich, V31	80251147	66
Holder, SST, French Fries, V31	80251148	66
Holder, SST, Ice Cream Cone, V31	80251149	66
Carrying Case, V31	80251216	103



Valor® 2000

A Rapid-Response Food Scale That Enhances Productivity in Harsh Environments

- Valor 2000 has a polycarbonate keypad that can endure contact with knives or sharp instruments used daily in demanding food preparation, processing and portioning applications.
- Safe to use in the weighing of liquids and in wet environments, Valor 2000 is NSF Certified and has a flow-thru design that ensures the scale remains clean and operational.
- With less than half a second stabilization time and front and rear LED displays, multiple operators can efficiently utilize one scale for the same job.

- Application** Weighing, Checkweighing (XW only)
- Display** Dual light emitting diode (LED) displays
- Operation** AC adapter (included) or rechargeable battery (included)
- Construction** ABS housing with stainless steel platform (PW), stainless steel housing and platform (XW), up-front level indicator
- Design Features** Auto-close power jack cover, transportation handle



60 lb models now available

XW Models Feature Stainless Steel Top Housing

Model	Protection Rating	Capacity	Readability	Platform Size	Item No.	Price USD
V22XWE1501T	IPX8	3 lb / 1.5 kg	0.0005 lb / 0.2 g	7.5 in x 9.5 in / 190 mm x 242 mm	30035439	470
V22XWE3T		6 lb / 3 kg	0.001 lb / 0.5 g	7.5 in x 9.5 in / 190 mm x 242 mm	30035440	470
V22XWE6T		15 lb / 6 kg	0.002 lb / 1 g	7.5 in x 9.5 in / 190 mm x 242 mm	30035441	470
V22XWE15T		30 lb / 15 kg	0.005 lb / 2 g	7.5 in x 9.5 in / 190 mm x 242 mm	30035442	470
V22XWE30T		60 lb / 30 kg	0.01 lb / 5 g	7.5 in x 9.5 in / 190 mm x 242 mm	30251705	470

PW Models Feature ABS Housing

Model	Protection Rating	Capacity	Readability	Platform Size	Item No.	Price USD
V22PWE1501T	IPX8	3 lb / 1.5 kg	0.0005 lb / 0.2 g	7.5 in x 9.5 in / 190 mm x 242 mm	30035682	393
V22PWE3T		6 lb / 3 kg	0.001 lb / 0.5 g	7.5 in x 9.5 in / 190 mm x 242 mm	30035683	393
V22PWE6T		15 lb / 6 kg	0.002 lb / 1 g	7.5 in x 9.5 in / 190 mm x 242 mm	30035684	393
V22PWE15T		30 lb / 15 kg	0.005 lb / 2 g	7.5 in x 9.5 in / 190 mm x 242 mm	30035685	393
V22PWE30T		60 lb / 30 kg	0.01 lb / 5 g	7.5 in x 9.5 in / 190 mm x 242 mm	30251704	393

Accessories	Item No.	Price USD
Large Pan, 11.8 x 8.8 in V22 V41	30251753	46



Compact Bench Scales

Valor® 1000

Economical, Multipurpose Weighing

- Valor 1000 is NSF Certified and supports HACCP-Certified systems helping to ensure the integrity and safety of all food products weighed on the scale.
- With software for general weighing, Checkweighing, and accumulation, Valor 1000 can be used for a variety of food weighing and measurement needs.
- An 80-hour internal rechargeable battery provides portability and ensures the scale will be operational when you need it.



- Application** Weighing, Checkweighing, Accumulation
- Display** Backlit liquid crystal display (LCD)
- Operation** AC adapter (included) or rechargeable battery (included)
- Construction** ABS housing, stainless steel platform, up-front level indicator
- Design Features** External calibration software, selectable environmental settings, selectable weighing units

Model	Dual Display	Capacity	Readability	Platform Size	Item No.	Price USD
V11P3		6.6 lb / 3 kg	0.001 lb / 0.5 g	9.9 in x 7.1 in / 250 mm x 180 mm	83998126	235
V11P3T	•			9.9 in x 7.1 in / 250 mm x 180 mm	83998172	245
V11P6		13 lb / 6 kg	0.002 lb / 1 g	9.9 in x 7.1 in / 250 mm x 180 mm	83998127	235
V11P6T	•			9.9 in x 7.1 in / 250 mm x 180 mm	83998173	245
V11P15		33 lb / 15 kg	0.005 lb / 2 g	9.9 in x 7.1 in / 250 mm x 180 mm	83998128	235
V11P15T	•			9.9 in x 7.1 in / 250 mm x 180 mm	83998174	245
V11P30		66 lb / 30 kg	0.01 lb / 5 g	9.9 in x 7.1 in / 250 mm x 180 mm	83998129	235
V11P30T	•			9.9 in x 7.1 in / 250 mm x 180 mm	83998175	245

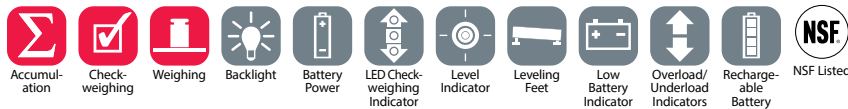

Catapult® 1000

Economical Compact Shipping Scales

- The sturdy ABS plastic housing and platform with optional stainless steel platform make Catapult sturdy yet easy to maneuver and fit into your workspace.
- Bring the Catapult 1000 right to your work with the integrated carrying handle and its battery powered operation.
- Catapult 1000 not only provides accurate general weight determination but also has the software to support dynamic/animal weighing and display hold.
- New WeighAlert mode in C11P75 model flashes weight display when weight on platform is greater than 70lb and less than 151lb, alerting user that package is too heavy for USPS service but below Less-Than-Truckload (LTL) limit for shipping.



WeighAlert mode now available



- Application** Weighing, Animal/Dynamic Weighing, Display Hold
- Display** Liquid crystal display (LCD)
- Operation** AC adapter (included) or 3 C (LR14) batteries (not included)
- Construction** ABS housing and platform, stainless steel platform (accessory sold separately), transportation handle
- Design Features** Low profile, compact design

Model	Capacity	Readability	Platform Size	Item No.	Price USD
C11P9	20 lb / 9 kg	0.01 lb / 0.005 kg	11 in x 12.4 in / 280 mm x 316 mm	83998137	227
C11P20	44 lb / 20 kg	0.02 lb / 0.01 kg	11 in x 12.4 in / 280 mm x 316 mm	83998138	227
C11P75	165 lb / 75 kg	0.1 lb / 0.05 kg	11 in x 12.4 in / 280 mm x 316 mm	83998139	253

Accessories	Item No.	Price USD
Pan, SST, C11P	80251248	42

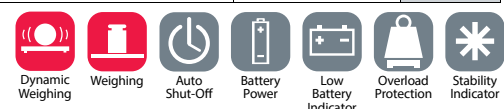

CKW55

Advanced Indicators Designed for Checkweighing Applications

- The CKW features multiple Checkweighing options including Positive, Negative, Zero or Net and statistical capabilities to provide accurate results for advanced Checkweighing needs.
- With multiple connectivity capabilities both built-in and available as accessories, such as RS232, RS422/485 and AC/DC relays, CKW55 provides multiple ways to record and log data.
- CKW55 is NSF Certified, USDA-AMS accepted, and supports HACCP-certified systems, and is safe for use in food processing applications.

- Application** Weighing, Checkweighing
- Display** Light emitting diode (LED) display, 24 segment traffic light LED bar graph
- Operation** AC power (included) or rechargeable battery (included)
- Communication** Easy access communication port including RS232 interface and external tare input (included) and RS422/485 or AC/DC relay outputs (accessories sold separately)
- Construction** NEMA 4X/IP66 stainless steel housing, numeric keypad, hinged front cover for easy servicing
- Design Features** Simple plug and play installation of accessories, 20,000d and up to 10,000e, 20 part library, 3-color 24-segment bar graph, beeper, and weight display alert Checkweighing indications, NSF listed and USDA-AMS accepted, Checkweighing target settings for range, variance by weight or percent, positive, negative, zero, or net Checkweighing methods, statistical function, NTEP Certified and Measurement Canada Approved



Model	Protection Rating	Item No.	Price USD
CKW55	IP66; NEMA 4X	80251030	605

Accessories	Item No.	Price USD
Wall Mount Kit, SST, CKW	71167964	194
Rechargeable Battery Kit, CKW	71167966	371
RS422/485 Kit, CKW	71167965	226
Relay Kit, AC, CKW	71167967	392
Relay Kit, DC, CKW	71173377	392
Cable, RS232, CKW TxxXW	80500552	142
Software, Winwedge	80850080	437
Cable ST103 - CKW55	80252584	172
Printer, Impact, SF40A, AM	30064203	798

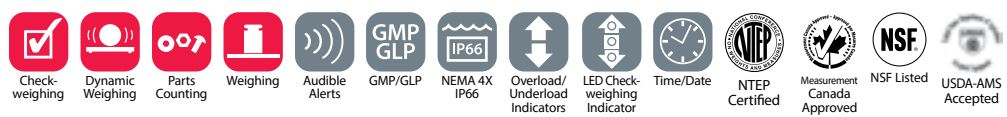

T72XW

Advanced Performance Stainless Steel Indicator with External Device Control Capabilities

- With a 50,000 displayed resolution and the ability to support up to 10 load cells, T72XW was designed for heavy-duty industrial applications.
- Two available option slots enable a wide range of connectivity interfaces. Control external devices using the discrete I/O interface and transfer data through the serial, USB or Ethernet ports.
- T72XW is very easy to set up and navigate, a vivid graphic display with on-screen prompts and an alphanumeric keypad with designated keys for common functions such as Tare and ID information.



Now with Truck In/Out Mode

- Application** Weighing, Parts Counting, Checkweighing, Animal / Dynamic Weighing , Totalization, Truck In/Out
- Display** Transflective graphic LCD with white backlight, 240 x 96 pixels
- Operation** AC Power (Included)
- Communication** RS232 and SD card reader with SD card included. Ethernet, USB/Discrete I/O or COM2 kit with 2nd RS232/485 available.
- Construction** IP66/NEMA 4X stainless steel housing and mounting bracket
- Design Features** User-configurable resolution 50,000d/10,000e, Checkweighing lights with selectable operation and audible signal settings, sealed front panel, five operating languages (English, Spanish, French, German and Italian), selectable environmental and auto-print settings, stability indicator, overload/underload indicators, NTEP Certified and Measurement Canada Approved

Model	Protection Rating	Item No.	Price USD
T72XW	IP66; NEMA 4X	30126959	825

Accessories	Item No.	Price USD
Printer, Impact, SF40A, AM	30064203	798
Ethernet Kit, T72XW	30132163	122
USB with I/O Kit, T72XW	30132164	136
COM2 Kit, T72XW	30132165	122
Column Adapter, SST, T32XW T51XW T71XW	72209340	42
Cable, RS232, CKW TxxXW	80500552	142
Cable ST103 - TxxXW	80252584	172
Software, Winwedge	80850080	437



T71XW

High Performance Stainless Steel Washdown Indicator for Advanced Applications



- T71XW can support advanced features such as accumulation mode, a 255-item library and optional alibi memory capability, and also has a 1:50,000 maximum displayed resolution.
- This advanced indicator has dual-scale capabilities in which it can display the weights from two platforms and is powerful enough to drive up to 8 - 350 ohm load cells per platform.
- With a full alphanumeric keypad and dual-line display, as well as SmarText™ software that utilizes text prompts to guide users through set up and use, T71XW is simple to operate.

- Application** Weighing, Parts Counting, Percent Weighing, Checkweighing, Dynamic/Animal Weighing, Accumulation, Display Hold
- Display** Backlit liquid crystal display (LCD) with secondary information line, 3 color Checkweighing LEDs
- Operation** Power cord (included) or rechargeable battery (accessory sold separately)
- Communication** RS232 (included). Internal 2nd RS232, RS232/RS485, AC or DC relay kits available. GLP/GMP data output with real-time clock.
- Construction** IP66/NEMA 4X stainless steel housing and mounting bracket
- Design Features** User-configurable resolution 50,000d/10,000e, Alibi memory kit (accessory sold separately), five operating languages, NTEP Certified and Measurement Canada Approved

Model	Protection Rating	Item No.	Price USD
T71XW	IP66; NEMA 4X	83999839	605

Accessories	Item No.	Price USD
Printer, Impact, SF40A, AM	30064203	798
Printer, Thermal, STP-103, US	80251992	622
PCBA Kit, Alibi Memory, R71 T71	80500503	97
Cable, RS232, CKW TxxXW	80500552	142
Relay Kit, AC, T51 T71	80500720	282
Relay Kit, DC, T51 T71	80500727	242
Rechargeable Battery Kit, T51 T71	80500729	182
RS422/485 Kit, T51 T71	80500731	79
RS232 Kit, T51 T71	80500733	59
Wall Mount Kit, SST, T51XW T71XW	80500735	65
Software, Winwedge	80850080	437
Column Kit, Painted, Floor Stand	30047153	86
Column Kit, Stainless Steel, Floor Stand	30047154	204
Cable ST103 - TxxXW	80252584	172

T71P

High Performance Indicator for Advanced Applications



- T71P can support advanced features such as accumulation mode, a 255-item library and optional alibi memory capability, and also has a 1:50,000 maximum displayed resolution.
- This advanced indicator has dual-scale capabilities in which it can display the weights from two platforms and is powerful enough to drive up to 8 - 350 ohm load cells per platform.
- With a full alphanumeric keypad and dual-line display, as well as SmarText™ software that utilizes text prompts to guide users through set up and use, T71P is simple to operate.

- Application** Weighing, Parts Counting, Percent Weighing, Checkweighing, Dynamic/Animal Weighing, Accumulation, Display Hold
- Display** Backlit liquid crystal display (LCD) with secondary information line, 3 color Checkweighing LEDs
- Operation** Power cord (included) or 6 C (LR14) batteries (not included) or rechargeable battery (accessory sold separately)
- Communication** RS232 (included). Internal 2nd RS232, RS232/RS485, AC or DC relay kits available. External RS232-USB or RS232-Ethernet connectors available. GLP/GMP data output with real-time clock.
- Construction** ABS housing and painted steel mounting bracket, non-slip rubber feet
- Design Features** User-configurable resolution 50,000d/10,000e, Alibi memory kit (accessory sold separately), five operating languages, NTEP Certified and Measurement Canada Approved

Model	Item No.	Price USD
T71P	83998180	500

Accessories	Item No.	Price USD
Printer, Impact, SF40A, AM	30064203	798
Wall Mount Kit, Painted, T51P T71P	72200227	47
Printer, Thermal, STP-103, US	80251992	622
PCBA Kit, Alibi Memory, R71 T71	80500503	97
Cable, RS232, IBM 9P, AV DV MB Ranger	80500525	155
Relay Kit, AC, T51 T71	80500720	282
Base Mount Kit, Painted, T51P T71P	80500722	45
Relay Kit, DC, T51 T71	80500727	242
Rechargeable Battery Kit, T51 T71	80500729	182
RS422/485 Kit, T51 T71	80500731	79
RS232 Kit, T51 T71	80500733	59
Software, Winwedge	80850080	437
Interface Kit, RS232-USB	30304101	116
Interface Kit, RS232-Ethernet	30304102	116

T51XW

Multifunctional Stainless Steel Washdown Indicator for Standard Industrial Applications



- T51XW features software for parts counting, dynamic weighing, percent weighing, Checkweighing, display hold for large containers and can meet traceability requirements.
- Multiple connectivity capabilities include built-in RS232 bi-directional interface and external input as well as optional RS422/485, second RS232 and AC or DC relay.
- The durably-built T51XW NEMA 4X/IP66 stainless steel water resistant indicator has a hinged front cover that opens easily for servicing and installation of the connectivity options.

- Application** Weighing, Parts Counting, Percent Weighing, Checkweighing, Dynamic/Animal Weighing, Display Hold
- Display** Backlit liquid crystal display (LCD), 3 color Checkweighing LEDs
- Operation** Power cord (included) or rechargeable battery (accessory sold separately)
- Communication** RS232 (included). Internal 2nd RS232, RS232/RS485, AC or DC relay kits available. GLP/GMP data output with real-time clock.
- Construction** IP66/NEMA 4X stainless steel housing and mounting bracket, four-key membrane keypad, easy-open hinged front cover
- Design Features** User-configurable resolution up to 30,000d/10,000e, NTEP Certified and Measurement Canada Approved

Model	Protection Rating	Item No.	Price USD
T51XW	IP66; NEMA 4X	83999840	571

Accessories	Item No.	Price USD
Printer, Impact, SF40A, AM	30064203	798
Printer, Thermal, STP-103, US	80251992	622
Cable, RS232, CKW TxxXW	80500552	142
Relay Kit, AC, T51 T71	80500720	282
Relay Kit, DC, T51 T71	80500727	242
Rechargeable Battery Kit, T51 T71	80500729	182
RS422/485 Kit, T51 T71	80500731	79
RS232 Kit, T51 T71	80500733	59
Wall Mount Kit, SST, T51XW T71XW	80500735	65
Cable Kit, Loadcell Adapter, T51 T71	80500736	56
Software, Winwedge	80850080	437
Column Kit, Painted, Floor Stand	30047153	86
Column Kit, Stainless Steel, Floor Stand	30047154	204
Cable ST103 - TxxXW	80252584	172

Checkweighing, Display Hold, Dynamic Weighing, G/N/T, Audible Alerts, Auto Shut-Off, Auto Standby, Backlight, Environmental Filters, GMP/GLP, LED Checkweighing Indicator, NTEP Certified, Parts Counting, Percent Weighing, Weighing, Low Battery Indicator, Overload/Underload Indicators, Software Lockout, Stability Indicator, Time/Date, NEMA 4X IP66, Measurement Canada Approved

T51P

Multifunctional ABS Plastic Indicator for Standard Industrial Applications

- T51P features software for parts counting, dynamic weighing, percent weighing, Checkweighing, display hold for large containers and can meet traceability requirements.
- Multiple connectivity capabilities include built-in RS232 bi-directional interface and external input as well as optional RS422/485, second RS232 and AC or DC relay.
- The durably-built ABS plastic housing T51P has a reversible rear cover that supplies multiple mounting options, including, wall, column, scale front, or table-top mounting.



- Application** Weighing, Parts Counting, Checkweighing, Dynamic/Animal Weighing, Display Hold, Percent Weighing
- Display** Backlit liquid crystal display (LCD), 3 color Checkweighing LEDs
- Operation** Power cord (included) or 6 C (LR14) batteries (not included) or rechargeable battery (accessory sold separately)
- Communication** RS232 (included). Internal 2nd RS232, RS232/RS485, AC or DC relay kits available. External RS232-USB or RS232-Ethernet connectors available. GLP/GMP data output with real-time clock.
- Construction** ABS housing and painted steel mounting bracket, four-key membrane keypad, reversible front cover, non-slip rubber feet
- Design Features** User-configurable resolution up to 30,000d/10,000e, NTEP Certified and Measurement Canada Approved

Model	Item No.	Price USD
T51P	83998179	467

Accessories	Item No.	Price USD
Printer, Impact, SF40A, AM	30064203	798
Printer, Thermal, STP-103, US	80251992	622
Cable, RS232, IBM 9P, AV DV MB Ranger	80500525	155
Cable, SF42-AV DV MB Ranger	80500571	155
Interface Kit, RS232-USB	30304101	116
Interface Kit, RS232-Ethernet	30304102	116
Relay Kit, AC, T51 T71	80500720	282
Base Mount Kit, Painted, T51P T71P	80500722	45
Relay Kit, DC, T51 T71	80500727	242
Rechargeable Battery Kit, T51 T71	80500729	182
RS422/485 Kit, T51 T71	80500731	79
RS232 Kit, T51 T71	80500733	59
Software, Winwedge	80850080	437
Column Kit, Painted, Floor Stand	30047153	86
Column Kit, Stainless Steel, Floor Stand	30047154	204

T32XW

Economical Stainless Steel Washdown Indicator for Basic Industrial Applications

- The NEMA 4X/IP65 stainless steel construction protects the indicator from water damage and a hinged front cover opens up easily, offering instant access for servicing.
- The long-lasting internal rechargeable battery provides continuous operation for up to 58 hours, ensuring uninterrupted operation for more than two straight days.
- Simple operation enhanced by an easy-to-read display and even basic counting mode round out this industrial indicator, making it ideal for everyday basic industrial use.



Application	Weighing, Parts Counting
Display	Backlit liquid crystal display (LCD)
Operation	Power cord (included) or rechargeable battery (included)
Communication	Easy access communication port including RS232 interface (included)
Construction	IP65/NEMA 4X stainless steel housing and mounting bracket, easy-open hinged front cover
Design Features	User-configurable resolution up to 20,000d/6,000e, NTEP Certified and Measurement Canada Approved

Model	Protection Rating	Item No.	Price USD
T32XW	IP65; NEMA 4X	83999823	407

Accessories	Item No.	Price USD
Printer, Impact, SF40A, AM	30064203	798
Printer, Thermal, STP-103, US	80251992	622
Cable, RS232, CKW TxxXW	80500552	142
Software, Winwedge	80850080	437
Column Kit, Painted, Floor Stand	30047153	86
Column Kit, Stainless Steel, Floor Stand	30047154	204
Cable ST103 - TxxXW	80252584	172

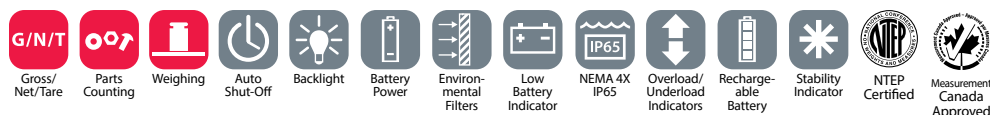

T32M

Economical Metal Indicator for Basic Industrial Applications

- T32MC and T32ME are OIML approved, NTEP certified, and Measurement Canada approved for use in all legal-for-trade applications.
- Application modes include weighing, simple parts counting, basic Checkweighing, display hold and accumulation of results.
- Constructed of painted steel housing and high-impact ABS faceplate, T32MC and T32ME are highly durable.

- Application** Weighing, Parts Counting, Checkweighing, Accumulation, Display Hold
- Display** T32MC: Backlit liquid crystal display (LCD) T32ME: Light-emitting diode display (LED)
- Operation** AC adapter (included)
- Communication** Easy access communication port including RS232 interface (included). External RS232-USB or RS232-Ethernet connectors available.
- Construction** Front ABS/rear painted steel housing and painted steel mounting bracket
- Design Features** User-configurable resolution up to 20,000d/6,000e, NTEP Certified and Measurement Canada Approved



Model	Item No.	Price USD
T32ME	83998166	259
T32MC	83998167	259

Accessories	Item No.	Price USD
Printer, Impact, SF40A, AM	30064203	798
Printer, Thermal, STP-103, US	80251992	622
Cable, RS232, IBM 9P, AV DV MB Ranger	80500525	155
Software, Winwedge	80850080	437
Column Kit, Painted, Floor Stand	30047153	86
Column Kit, Stainless Steel, Floor Stand	30047154	204
Interface Kit, RS232-USB	30304101	116
Interface Kit, RS232-Ethernet	30304102	116

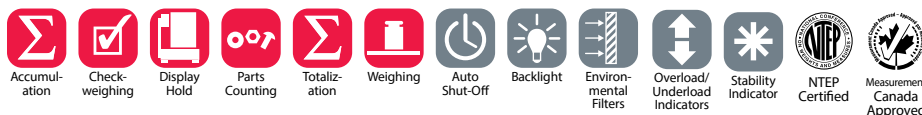

T31P

Economical ABS Plastic Indicator for Basic Industrial Applications

- T31P is OIML approved, NTEP certified and Measurement Canada approved for use in all legal-for-trade applications.
- The ultra-long-lasting internal rechargeable battery provides operation on a single charge for up to 120 hours.
- The reversible rear cover offers the flexibility for connected cables to exit above or below the indicator housing.

Application Weighing, Parts Counting

Display Backlit liquid crystal display (LCD)

Operation AC adapter (included) or rechargeable battery (included)

Communication Easy access communication port including RS232 interface (included). External RS232-USB or RS232-Ethernet connectors available.

Construction ABS housing and painted steel mounting bracket, non-slip rubber feet

Design Features User-configurable resolution up to 20,000d/6,000e, NTEP Certified and Measurement Canada Approved



Front mount handle accessory now available

Model	Item No.	Price USD
T31P	83998110	333

Accessories	Item No.	Price USD
Printer, Impact, SF40A, AM	30064203	798
Printer, Thermal, STP-103, US	80251992	622
Cable, RS232, IBM 9P, AV DV MB Ranger	80500525	155
Software, Winwedge	80850080	437
Column Kit, Painted, Floor Stand	30047153	86
Column Kit, Stainless Steel, Floor Stand	30047154	204
Interface Kit, RS232-USB	30304101	116
Interface Kit, RS232-Ethernet	30304102	116
Handle Kit, D3K	30381321	80

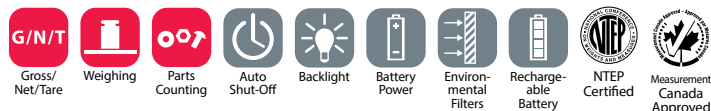

CKW Bases

High Quality Washdown Checkweighing Base

- The CKW base is NSF Certified, USDA-AMS Accepted, supports HACCP-certified systems, and is safe for use in food processing applications.
- Constructed with IP67 stainless steel, the CKW base is protected from harsh elements and can be thoroughly washed down to ensure cleanliness.
- The external level indicator and adjustable non-slip leveling feet assure that the base is stable and producing accurate results.



Construction 304 grade stainless steel platform with no visible threads, rounded corners, drain holes, extended skirt and open frame, IP67

Design Features No visible threads for conformance to food safety requirements, NSF Certified, USDA-AMS Accepted, and supports HACCP-certified systems with "NTEP Certified and Measurement Canada Approved"

Model	Capacity	Readability	Certified Readability	Platform Size	Item No.	Price USD
CKW3R	6 lb / 3 kg	0.001 lb / 0.5 g	0.002 lb / 1 g	10 in x 10 in / 254 mm x 254 mm	30379430	753
CKW6R	15 lb / 6 kg	0.002 lb / 1 g	0.005 lb / 2 g	10 in x 10 in / 254 mm x 254 mm	30379431	753
CKW15L	30 lb / 15 kg	0.005 lb / 2 g	0.01 lb / 5 g	12 in x 12 in / 305 mm x 305 mm	30379432	876
CKW30L	60 lb / 30 kg	0.01 lb / 5 g	0.02 lb / 10 g	12 in x 12 in / 305 mm x 305 mm	30379433	876



Defender® W Series Stainless Steel Bases

Top Quality Base for Washdown Industrial Weighing

- The stainless steel form-and-weld frame and stainless steel platform provide ample support for industrial weighing applications.
- Marked by durability, rigidity and structural integrity, Defender W Series bases are constructed to perform highly in industrial environments.
- Defender W Series bases have resolutions of up to 15,000d to meet the needs of industrial weighing applications that require extreme accuracy.



Construction 304 grade stainless steel platform, stainless steel form-and-weld frame, IP67 stainless steel load cell, level indicator

Design Features NTEP Certified and Measurement Canada Approved, Wheel kits (optional)

Model	Capacity	Readability	Certified Readability	Platform Size	Item No.	Price USD
D10WR	25 lb / 10 kg	0.002 lb / 1 g	0.005 lb / 2 g	12 in x 12 in / 305 mm x 305 mm	80251925	891
D25WR	50 lb / 25 kg	0.005 lb / 2 g	0.01 lb / 5 g	12 in x 12 in / 305 mm x 305 mm	80251926	891
D50WL	100 lb / 50 kg	0.01 lb / 5 g	0.02 lb / 10 g	18 in x 18 in / 457 mm x 457 mm	80251927	956
D100WL	250 lb / 100 kg	0.02 lb / 10 g	0.05 lb / 20 g	18 in x 18 in / 457 mm x 457 mm	80251928	1322
D250WX	500 lb / 250 kg	0.05 lb / 20 g	0.1 lb / 50 g	24 in x 24 in / 610 mm x 610 mm	80251929	2022



Defender® H Series Bases

High Quality Bases For Industrial Environments

- The black polyurethane painted steel form-and-weld frame and stainless steel platform provides ample support for industrial weighing applications.
- Marked by durability, rigidity and structural integrity, Defender H Series bases are constructed to perform highly in industrial environments.
- Defender H Series bases are high resolution and can meet the needs of industrial weighing applications that require extreme accuracy.



Construction 304 grade stainless steel platform, black polyurethane painted steel form-and-weld frame, IP67 aluminum load cell, level indicator

Design Features 150% capacity overload protection, NTEP Certified and Measurement Canada Approved, Wheel kits (optional)

Model	Capacity	Readability	Certified Readability	Platform Size	Item No.	Price USD
D15HR	30 lb / 15 kg	0.002 lb / 1 g	0.01 lb / 5 g	14 in x 12 in / 355 mm x 305 mm	30379448	760
D30HR	60 lb / 30 kg	0.005 lb / 2 g	0.02 lb / 10 g	14 in x 12 in / 355 mm x 305 mm	30379449	760
D60HR	150 lb / 60 kg	0.01 lb / 5 g	0.05 lb / 20 g	14 in x 12 in / 355 mm x 305 mm	30379450	760
D60HL				16 in x 20 in / 400 mm x 500 mm	30379451	760
D100HL	250 lb / 100 kg	0.02 lb / 10 g	0.1 lb / 50 g	16 in x 20 in / 400 mm x 500 mm	30379452	977
D150HX	300 lb / 150 kg			22 in x 17 in / 550 mm x 420 mm	30379453	1199
D300HX	600 lb / 300 kg	0.05 lb / 50 g	0.2 lb / 100 g	22 in x 17 in / 550 mm x 420 mm	30379454	1199



Defender® Q Series Bases

Top Quality Base for Industrial Weighing

- A black polyurethane painted steel form-and-weld frame with stainless steel platform provides ample support for industrial weighing applications.
- Marked by durability, rigidity and structural integrity, Defender Q Series bases are constructed to perform highly in industrial environments.
- Defender Q Series bases have resolutions of up to 15,000d to meet the needs of industrial weighing applications that require extreme accuracy.



Construction 304 grade stainless steel platform, painted carbon steel form-and-weld frame, IP67 aluminum load cell, level indicator

Design Features 150% capacity overload protection, NTEP Certified and Measurement Canada Approved, Wheel kits (optional)

Model	Protection Rating	Capacity	Readability	Certified Readability	Platform Size	Item No.	Price USD
D10QR	IP67	25 lb / 10 kg	0.002 lb / 1 g	0.005 lb / 2 g	12 in x 12 in / 305 mm x 305 mm	80251920	673
D25QR		50 lb / 25 kg	0.005 lb / 2 g	0.01 lb / 5 g	12 in x 12 in / 305 mm x 305 mm	80251921	757
D50QL		100 lb / 50 kg	0.01 lb / 5 g	0.02 lb / 10 g	18 in x 18 in / 457 mm x 457 mm	80251922	757
D100QL		250 lb / 100 kg	0.02 lb / 10 g	0.05 lb / 20 g	18 in x 18 in / 457 mm x 457 mm	80251923	1041
D250QX		500 lb / 250 kg	0.05 lb / 20 g	0.1 lb / 50 g	24 in x 24 in / 610 mm x 610 mm	80251924	1398



Defender® V Series Stainless Steel Bases

Economical Base for Washdown Industrial Weighing

- The sturdy tubular 304 stainless steel platform provides ample support for industrial weighing applications.
- The IP67 load cells ensure accurate and repeatable results.
- The non-slip adjustable rubber leveling feet provide stability during the weighing process.



30 lb model now available

Construction 304 grade stainless steel platform, stainless steel tubular frame, IP67 stainless steel load cell, level indicator

Design Features 125% capacity overload protection, NTEP Certified and Measurement Canada Approved, Wheel kits (optional)

Model	Capacity	Readability	Certified Readability	Platform Size	Item No.	Price USD
D15VR	30 lb / 15 kg	0.005 lb / 2g	0.01 lb / 5 g	14 in x 12 in / 355 mm x 305 mm	30379441	693
D30VR	60 lb / 30 kg	0.01 lb / 5 g	0.02 lb / 10 g	14 in x 12 in / 355 mm x 305 mm	30379442	693
D60VR	150 lb / 60 kg	0.02 lb / 10 g	0.05 lb / 20 g	14 in x 12 in / 355 mm x 305 mm	30379443	693
D60VL				21.7 in x 16.5 in / 550 mm x 420 mm	30379444	1176
D150VL	300 lb / 150 kg	0.05 lb / 20 g	0.1 lb / 50 g	21.7 in x 16.5 in / 550 mm x 420 mm	30379445	1176
D150VX				25.6 in x 19.7 in / 650 mm x 500 mm	30379446	1748
D300VX				25.6 in x 19.7 in / 650 mm x 500 mm	30379447	1748



Defender® B Series Bases

Economical Base for Industrial Weighing

- The sturdy tubular 304 stainless steel platform provides ample support for industrial weighing applications.
- The IP67 load cells ensure accurate and repeatable results.
- The non-slip adjustable rubber leveling feet provide stability during the weighing process.



30 lb model now available

Construction 304 grade stainless steel platform, black painted steel tubular frame, IP67 aluminum load cell, level indicator

Design Features 125% capacity overload protection, NTEP Certified and Measurement Canada Approved, Wheel kits (optional)

Model	Capacity	Readability	Certified Readability	Platform Size	Item No.	Price USD
D15BR	30lb / 15kg	0.005 lb / 2g	0.01 lb / 5 g	14 in x 12 in / 355 mm x 305 mm	30379434	634
D30BR	60 lb / 30 kg	0.01 lb / 5 g	0.02 lb / 10 g	14 in x 12 in / 355 mm x 305 mm	30379435	634
D60BR	150 lb / 60 kg	0.02 lb / 10 g	0.05 lb / 20 g	14 in x 12 in / 355 mm x 305 mm	30379436	634
D60BL				21.7 in x 16.5 in / 550 mm x 420 mm	30379437	634
D150BL	300 lb / 150 kg	0.05 lb / 20 g	0.1 lb / 50 g	21.7 in x 16.5 in / 550 mm x 420 mm	30379438	634
D150BX				25.6 in x 19.7 in / 650 mm x 500 mm	30379439	634
D300BX				25.6 in x 19.7 in / 650 mm x 500 mm	30379440	634



Aviator 7000*

Versatile Counter Top Price Computing Scale for Retail Business

- Quick-response light-touch keyboard with exchangeable preset card and keysheet layers.
- Standard alkaline D-cell or rechargeable NiMH batteries plus integrated carry handles for portability.
- Multiple connection possibilities - RS232 or USB to POS, RS232 to external printer.

- Application** Weighing, Price Computing
- Display** 4-line backlit LCD including 6-digit weight, 6-digit unit price, 7-digit total price and 4-digit preset tare line
- Operation** AC Adapter (Included) or 6 Alkaline (Not included) or 6 NiMH Rechargeable D- cell Batteries (available as an Accessory)
- Communication** RS232 (Available as an Accessory), USB (as an accessory)
- Construction** ABS housing with stainless steel platform
- Design Features** 100 PLU and 24 preset keys plus exchangeable preset card and keysheet layers, adjustable rubber non-slip feet & front level bubble, integrated adapter storage and carry handles, NTEP Certified



Model	Capacity	Readability	Certified Readability	Platform Size	Item No.	Price USD
A71P15DNUS	15 lb; 30 lb /	0.005 lb; 0.01 lb /	0.005 lb; 0.01 lb /	9.5 in x 13.3 in / 240 mm x 337 mm	72248760	406
A71P15DTNUS	6 kg; 15 kg	2 g; 5 g	2 g; 5 g		72248762	463
A71P30DNUS	30 lb; 60 lb /	0.01 lb; 0.02 lb /	0.01 lb; 0.02 lb /		72248761	406
A71P30DTNUS	15 kg; 30 kg	5 g; 10 g	5 g; 10 g		72248763	463

Accessories	Item No.	Price USD
Printer, Impact, SF40A, AM	30064203	798
Rechargeable Battery, x6, NiMH, bRite A71	72151831	187
SP, Keypad, Silicone, bRite A71	72231249	26
Keypad White Silicone Pad bRite A71	72231250	20
Cable, RJ45-RS232, POS, bRite A71	72237981	38
Cable, RJ45-USB, POS, bRite A71	72237984	38
Function Keyboard NA 100g OHAUS bLite	72241852	14

Accessories	Item No.	Price USD
In-Use-Cover, bRite A51 A71	72247038	30
In-Use-Cover, Pan, bRite A51 A71	72247039	20
Pan, Rectangle, Deep, bRite A51 A71	72247115	100
Cable, RJ45-RS232, Printer, bRite A71	72249531	38
Thermal Printer Head Assy bRite A71 AM	72253293	622
Paper Roll, (1), Printer, bRite A71	72255953	16
Printer, Thermal, STP-103, US	80251992	622

* Available exclusively in U.S.



Calibration Weights



OHAUS' portfolio now includes the Troemner library of weights, backed by exclusive construction and more than 100 years of expertise. With a wide selection of weight classes backed by both ASTM and OIML, OHAUS weights offer a comprehensive range of 1mg to 2000kg, and are available with certifications.





Our weights and weight sets are backed by the world's leading supplier of precision weights and mass standards. Since 1838, Troemner has enhanced its reputation as being the premier precision weight company by having industry recognized metrologists and highly trained calibrators on staff. Troemner's production of precision weights involves using the finest materials and equipment available in a state-of-the-art facility. For these important reasons, Troemner is capable of providing unmatched measurements and metrological analysis, to provide our customers with the precision weights they need.

Only the finest raw materials are selected in order to manufacture high quality weights. Troemner is the only supplier that has a special stainless steel blend called Troemner Alloy 8, which possesses closely controlled density (8.03 g/cm³), extremely low magnetic properties, good stability and resistance to corrosion.

Weight Selector Guide

Troemner UltraClass - For analytical and microbalances with readability as low as 1 g. These are the most precise two-piece weights available, with weight tolerances 40 to 50% better than ANSI/ASTM Class 1. Ultra Class weights combine high precision with the advantage of two-piece construction (1 g and larger) to avoid costly issues associated with one-piece weights.

ANSI/ASTM Class 1 - Can be used as a reference standard in calibrating other weights and is appropriate for calibrating high-precision analytical balances with a readability as low as 0.1 mg to 0.01 mg.

ANSI/ASTM Class 4 - For calibration of semi-analytical balances and for student use.

ANSI/ASTM Class 6 - This class meets the specifications of OIML R 111 Class M2.

OIML Class E1 - Used as a primary reference for calibrating other reference standards and weights where the stability of the environment and careful handling are assured. Class E1 weights have no method of adjustment and are not suitable for general laboratory use. The uncertainty is guaranteed to be 1/3 the tolerance.

OIML Class E2 - Can be used as a reference standard in calibrating other weights and is appropriate for calibrating high-precision analytical balances with a readability as low as 0.1 mg to 0.01 mg.

OIML Class F1 - Appropriate for calibrating high-precision top loading balances with a readability as low as 0.01 g to 0.001 g.

OIML Class F2 - For calibration of semi-analytical balances and for student use.

NIST Class F - Primarily used to test commercial weighing devices by state and local weights and measures officials, device installers, and service technicians.

Troemner UltraClass Individual Weights

Weight tolerance is equal to ANSI/ASTM E617 Class 0

- UltraClass weights combine high precision with the advantage of two-piece construction (1 g and larger) avoiding costly replacement issues associated with one-piece weights.
- Weights are designed so the specifications on surface finish, markings, construction, material density, and magnetic properties become more restrictive as the weight tolerances decrease.
- Individual weights 1 mg through 10 kg are supplied in durable polycarbonate cases. Case lids lock tightly to ensure that your weight is held securely and kept clean and dust free.



Without Certificate		
Model	Item No.	Price USD
50 kg	30390204	9661
30 kg	30390203	6545
25 kg	30390202	5185
20 kg	30390201	2805
10 kg	30390200	2401
5 kg	30390199	1298
3 kg	30390198	1123
2 kg	30390197	876
1 kg	30390196	553
500 g	30390195	269
300 g	30390194	198
200 g	30390193	186
100 g	30390192	121
50 g	30390191	98
30 g	30390190	98
20 g	30390189	82
10 g	30390188	82
5 g	30390187	82
3 g	30390186	82
2 g	30390185	82
1 g	30390184	82
500 mg	30390183	81
300 mg	30390182	81
200 mg	30390181	81
100 mg	30390180	81
50 mg	30390179	81
30 mg	30390178	81
20 mg	30390177	81
10 mg	30390176	81
5 mg	30390175	81
3 mg	30390174	81
2 mg	30390173	81
1 mg	30390172	81

Traceable Certificate		
Model	Item No.	Price USD
50 kg	30390236	10328
30 kg	30390235	6578
25 kg	30390234	5247
20 kg	30390233	2948
10 kg	30390232	2526
5 kg	30390231	1356
3 kg	30390230	1183
2 kg	30390229	943
1 kg	30390228	625
500 g	30390227	310
300 g	30390226	254
200 g	30390225	227
100 g	30390224	126
50 g	30390223	122
30 g	30390222	121
20 g	30390221	100
10 g	30390220	100
5 g	30390219	92
3 g	30390218	92
2 g	30390217	92
1 g	30390216	92
500 mg	30390215	90
300 mg	30390214	90
200 mg	30390213	90
100 mg	30390212	90
50 mg	30390211	90
30 mg	30390210	90
20 mg	30390209	90
10 mg	30390208	90
5 mg	30390207	90
3 mg	30390206	90
2 mg	30390205	90
1 mg	30390204	90

NVLAP Certificate		
Model	Item No.	Price USD
50 kg	30390269	10550
30 kg	30390268	7253
25 kg	30390267	5333
20 kg	30390266	3041
10 kg	30390265	2860
5 kg	30390264	1525
3 kg	30390263	1265
2 kg	30390262	1026
1 kg	30390261	710
500 g	30390260	350
300 g	30390259	294
200 g	30390258	286
100 g	30390257	186
50 g	30390256	168
30 g	30390255	168
20 g	30390254	156
10 g	30390253	147
5 g	30390252	147
3 g	30390251	147
2 g	30390250	147
1 g	30390249	147
500 mg	30390248	133
300 mg	30390247	133
200 mg	30390246	133
100 mg	30390245	133
50 mg	30390244	133
30 mg	30390243	133
20 mg	30390242	133
10 mg	30390241	133
5 mg	30390240	133
3 mg	30390239	133
2 mg	30390238	133
1 mg	30390237	133



ASTM Class 1 Individual Weights

Adjusted to meet ASTM Class 1 Tolerances

- Can be used as a reference standard in calibrating other weights and is appropriate for calibrating high-precision analytical balances with a readability as low as 0.1 mg to 0.01 mg.
- Weights are designed so the specifications on surface finish, markings, construction, material density, and magnetic properties become more restrictive as the weight tolerances decrease.
- Individual weights 1 mg through 10 kg are supplied in durable polycarbonate cases. Case lids lock tightly to ensure that your weight is held securely and kept clean and dust free.



Without Certificate		
Model	Item No.	Price USD
50 kg	30391425	9347
30 kg	30391424	5951
25 kg	30391423	4711
20 kg	30391422	3205
10 kg	30391421	2190
5 kg	30391420	1190
3 kg	30391419	1018
2 kg	30391418	795
1 kg	30391417	505
500 g	30391416	237
300 g	30391415	181
200 g	80781143	176
100 g	80781141	109
50 g	80781139	97
30 g	30391411	88
20 g	80781135	89
10 g	80781133	85
5 g	80781131	82
3 g	30391407	77
2 g	80781127	77
1 g	80781125	77
500 mg	80781123	76
300 mg	30391403	76
200 mg	80781119	76
100 mg	80781117	76
50 mg	80781115	76
30 mg	30391399	76
20 mg	80781111	76
10 mg	80781109	76
5 mg	80781107	76
3 mg	30391395	76
2 mg	80781103	76
1 mg	80781101	76

Traceable Certificate		
Model	Item No.	Price USD
50 kg	30391607	10110
30 kg	30391606	6412
25 kg	30391605	4753
20 kg	30391604	3330
10 kg	30391603	2242
5 kg	30391602	1292
3 kg	30391601	1165
2 kg	30391600	877
1 kg	30391599	595
500 g	30391598	289
300 g	30391597	242
200 g	30391596	226
100 g	30391595	136
50 g	30391594	123
30 g	30391593	115
20 g	30391592	118
10 g	30391591	116
5 g	30391590	109
3 g	30391589	90
2 g	30391588	105
1 g	30391587	90
500 mg	30391586	87
300 mg	30391585	87
200 mg	30391584	87
100 mg	30391583	87
50 mg	30391582	87
30 mg	30391581	87
20 mg	30391580	87
10 mg	30391579	87
5 mg	30391578	87
3 mg	30391577	87
2 mg	30391576	87
1 mg	30391575	87

NVLAP Certificate		
Model	Item No.	Price USD
50 kg	30391458	10343
30 kg	30391457	6910
25 kg	30391456	4808
20 kg	30391455	3389
10 kg	30391454	2308
5 kg	30391453	1443
3 kg	30391452	1195
2 kg	30391451	945
1 kg	30391450	662
500 g	30391449	341
300 g	30391448	275
200 g	80781144	274
100 g	80781142	161
50 g	80781140	149
30 g	30391444	140
20 g	80781136	147
10 g	80781134	146
5 g	80781132	135
3 g	30391440	128
2 g	80781128	131
1 g	80781126	126
500 mg	80781124	119
300 mg	30391436	119
200 mg	80781120	119
100 mg	80781118	119
50 mg	80781116	119
30 mg	30391432	119
20 mg	80781112	119
10 mg	80781110	119
5 mg	80781108	119
3 mg	30391428	119
2 mg	80781104	119
1 mg	80781102	119

ASTM Class 4 Individual Weights

Adjusted to meet ASTM Class 4 Tolerances

- Can be used for calibration of semi-analytical balances and for student use.
- Weights are designed so the specifications on surface finish, markings, construction, material density, and magnetic properties become more restrictive as the weight tolerances decrease.
- Individual weights 1 mg through 10 kg are supplied in durable polycarbonate cases. Case lids lock tightly to ensure that your weight is held securely and kept clean and dust free.



Without Certificate		
Model	Item No.	Price USD
50 kg	30391295	9012
30 kg	30391294	5610
25 kg	30391293	4248
20 kg	30391292	2332
10 kg	30391291	1647
5 kg	30391290	1091
3 kg	30391289	891
2 kg	30391288	697
1 kg	30391287	445
500 g	30391286	208
300 g	30391285	146
200 g	30391284	130
100 g	80780063	84
50 g	80780075	69
30 g	30391281	69
20 g	80780068	60
10 g	80780062	60
5 g	80780074	48
3 g	30391277	48
2 g	80780067	48
1 g	80780061	48
500 mg	80780073	34
300 mg	30391273	32
200 mg	80780066	34
100 mg	80780060	34
50 mg	80780072	34
30 mg	30391269	32
20 mg	80780065	34
10 mg	80780059	34
5 mg	80780071	34
3 mg	30391265	32
2 mg	80780064	34
1 mg	80780058	33

Traceable Certificate		
Model	Item No.	Price USD
50 kg	30391108	8991
30 kg	30391107	5662
25 kg	30391106	4331
20 kg	30391105	2374
10 kg	30391104	1713
5 kg	30391103	1156
3 kg	30391102	940
2 kg	30391101	810
1 kg	30391100	489
500 g	30391099	254
300 g	30391098	186
200 g	30391097	170
100 g	30391096	93
50 g	30391095	78
30 g	30391094	78
20 g	30391093	94
10 g	30391092	91
5 g	30391091	57
3 g	30391090	57
2 g	30391089	83
1 g	30391088	57
500 mg	30391087	65
300 mg	30391086	51
200 mg	30391085	65
100 mg	30391084	65
50 mg	30391083	65
30 mg	30391082	49
20 mg	30391081	65
10 mg	30391080	65
5 mg	30391079	65
3 mg	30391078	51
2 mg	30391077	65
1 mg	30391076	65

NVLAP Certificate		
Model	Item No.	Price USD
50 kg	30391328	9159
30 kg	30391327	5831
25 kg	30391326	5848
20 kg	30391325	2541
10 kg	30391324	1875
5 kg	30391323	1233
3 kg	30391322	1016
2 kg	30391321	851
1 kg	30391320	534
500 g	30391319	286
300 g	30391318	225
200 g	30391317	208
100 g	80850287	137
50 g	80850297	130
30 g	30391314	130
20 g	80850292	126
10 g	80850286	122
5 g	80850296	118
3 g	30391310	118
2 g	80850291	117
1 g	80850285	113
500 mg	80850295	97
300 mg	30391306	95
200 mg	80850290	96
100 mg	80850284	96
50 mg	80850294	97
30 mg	30391302	96
20 mg	80850289	96
10 mg	80850283	97
5 mg	80850293	95
3 mg	30391298	96
2 mg	80850288	96
1 mg	80850282	96



Cal-Paks

Designed for Routine Maintenance of Your Balance

- The three weights included in the set will test the accuracy and linearity of your balance throughout its entire range.
- Cal-Pak components and carrying case are linked through the use of a unique serial number. You can trace your individual weights to the appropriate NVLAP Certificate and master carrying case.
- Cal-Paks are supplied in a case with accessories for care and handling of the weights including gloves and forceps.



Model	Item No.	Price USD
2 G-1 MG CAL-PAK ULTRAClass W/ NVLAP	30391799	391
5 G-1 MG CAL-PAK ULTRAClass W/ NVLAP	30391798	392
20 G-20 MG CAL-PAK CL 1 W/ NVLAP	30391797	385
20 G-200 MG CAL-PAK CL 1 W/ NVLAP	30391796	385
50 G-200 MG CAL-PAK CL 1 W/ NVLAP	30390007	374
50 G-2 G CAL-PAK CL 1 W/ NVLAP	30391795	374
100 G-20 MG CAL-PAK CL 1 W/NVLAP	30391794	374
100 G-200 MG CAL-PAK CL 1 W/NVLAP	30391793	374
100 G-2 G CAL-PAK CL 1 W/NVLAP	30391792	387
200 G-200 MG CAL-PAK CL 1 W/NVLAP	30391791	437
200 G-2 G CAL-PAK CL 1 W/NVLAP	30391790	437
500 G-20 MG CAL-PAK CL 1 W/NVLAP	30391789	552
500 G-200 MG CAL-PAK CL 1 W/NVLAP	30391788	552
500 G-2 G CAL-PAK CL 1 W/NVLAP	30391787	552
1 KG-2 G CAL-PAK CL 1 W/NVLAP	30391786	680
1 KG-20 G CAL-PAK CL 1 W/NVLAP	30391785	815
2 KG-2 G CAL-PAK CL 1 W/NVLAP	30391784	992
2 KG-20 G CAL-PAK CL 1 W/NVLAP	30391783	1271
5 KG-2 G CAL-PAK CL 1 W/NVLAP	30390006	1334
5 KG-2 G CAL-PAK CLASS 1 W/NVLAP	30390005	1422
5 KG-20 G CAL-PAK CL 1 W/NVLAP	30391782	1482
5 KG-20 G CAL-PAK CLASS 1 W/NVLAP	30390004	1459
5 KG-2 G CAL-PAK CL 1 W/NVLAP	30390003	1460
5 KG-2 G CAL-PAK CLASS 1 W/NVLAP	30390002	1552
5 KG-20 G CAL-PAK CL 1 W/NVLAP	30390001	1404
5 KG-20 G CAL-PAK CLASS 1 W/NVLAP	30390000	1552

Troemner UltraClass Weight Sets

Weight tolerance is equal to ANSI/ASTM E617 Class 0



- UltraClass weights combine high precision with the advantage of two-piece construction (1 g and larger) avoiding costly replacement issues associated with one-piece weights.
- Weights are designed so the specifications on surface finish, markings, construction, material density, and magnetic properties become more restrictive as the weight tolerances decrease.
- Weight sets 500 g and below include a polycarbonate case. Weight sets where the largest weight is 1 kg and above are supplied in a tough, lightweight, rugged case, designed to protect your weight set under any shipping circumstance.

Without Certificate		
Model	Item No.	Price USD
50 kg-1 g	30390097	24399
50 kg-1 mg	30390096	24844
30 kg-1 g	30390095	17035
30 kg-1 mg	30390094	17854
25 kg-1 g	30390093	16738
25 kg-1 mg	30390092	17257
20 kg-1 g	30390091	10861
20 kg-1 mg	30390090	11156
10 kg-1 g	30390089	8481
10 kg-1 mg	30390088	8927
5 kg-1 g	30390087	5804
5 kg-1 mg	30390086	6398
2 - 2 kg-1 g	30390011	4614
2 - 2 kg-1 mg	30390010	5060
2 kg-1 g	30390085	3869
2 kg-1 mg	30390084	4466
1 kg-1 g	30390083	2865
1 kg-1 mg	30390082	3497
500 g-1 g	30390081	1934
500 g-1 mg	30390080	2527
2 - 200 g-1 g	30390009	1095
2 - 200 g-1 mg	30390008	1548
200 g-1 g	30390079	991
200 g-1 mg	30390078	1414
100 g-1 g	30390077	830
100 g-100 mg	30390076	1012
100 g-10 mg	30390075	1219
100 g-5 mg	30390074	1270
100 g-1 mg	30390073	1322
50 g-1 g	30390072	888
50 g-100 mg	30390071	978
50 g-10 mg	30390070	1159
50 g- 5 mg	30390069	1227
50 g-1 mg	30390068	1398
20 g-1 g	30390067	746
20 g-100 mg	30390066	932
20 g-10 mg	30390065	1100
20 g-5 mg	30390064	1178
20 g-1 mg	30390063	1347
500 mg-10 mg	30390062	539
500 mg-1 mg	30390061	805

Traceable Certificate		
Model	Item No.	Price USD
50 kg-1 g	30390134	26227
50 kg-1 mg	30390133	27252
30 kg-1 g	30390132	18682
30 kg-1 mg	30390131	19487
25 kg-1 g	30390130	17072
25 kg-1 mg	30390129	17727
20 kg-1 g	30390128	12162
20 kg-1 mg	30390127	12895
10 kg-1 g	30390126	8791
10 kg-1 mg	30390125	9670
5 kg-1 g	30390124	6447
5 kg-1 mg	30390123	7364
2 - 2 kg-1 g	30390015	5350
2 - 2 kg-1 mg	30390014	6228
2 kg-1 g	30390122	4250
2 kg-1 mg	30390121	5057
1 kg-1 g	30390120	3311
1 kg-1 mg	30390119	4207
500 g-1 g	30390118	2417
500 g-1 mg	30390117	3298
2 - 200 g-1 g	30390013	1326
2 - 200 g-1 mg	30390012	2235
200 g-1 g	30390116	1160
200 g-1 mg	30390115	2044
100 g-1 g	30390114	995
100 g-100 mg	30390113	1242
100 g-10 mg	30390112	1575
100 g-5 mg	30390111	1628
100 g-1 mg	30390110	1750
50 g-1 g	30390109	1008
50 g-100 mg	30390108	1252
50 g-10 mg	30390107	1547
50 g- 5 mg	30390106	1642
50 g-1 mg	30390105	1773
20 g-1 g	30390104	877
20 g-100 mg	30390103	1060
20 g-10 mg	30390102	1442
20 g-5 mg	30390101	1349
20 g-1 mg	30390100	1677
500 mg-10 mg	30390099	843
500 mg-1 mg	30390098	990

NVLAP Certificate		
Model	Item No.	Price USD
50 kg-1 g	30390171	26812
50 kg-1 mg	30390170	27765
30 kg-1 g	30390169	19151
30 kg-1 mg	30390168	20324
25 kg-1 g	30390167	17479
25 kg-1 mg	30390166	18477
20 kg-1 g	30390165	12492
20 kg-1 mg	30390164	13656
10 kg-1 g	30390163	9312
10 kg-1 mg	30390162	10403
5 kg-1 g	30390161	7121
5 kg-1 mg	30390160	8103
2 - 2 kg-1 g	30390019	5730
2 - 2 kg-1 mg	30390018	6892
2 kg-1 g	30390159	4579
2 kg-1 mg	30390158	5716
1 kg-1 g	30390157	3709
1 kg-1 mg	30390156	4851
500 g-1 g	30390155	2748
500 g-1 mg	30390154	3913
2 - 200 g-1 g	30390017	1705
2 - 200 g-1 mg	30390016	3041
200 g-1 g	30390153	1539
200 g-1 mg	30390152	2711
100 g-1 g	30390151	1344
100 g-100 mg	30390150	1760
100 g-10 mg	30390149	2163
100 g-5 mg	30390148	2044
100 g-1 mg	30390147	2484
50 g-1 g	30390146	1289
50 g-100 mg	30390145	1648
50 g-10 mg	30390144	2044
50 g- 5 mg	30390143	1985
50 g-1 mg	30390142	2374
20 g-1 g	30390141	1008
20 g-100 mg	30390140	1473
20 g-10 mg	30390139	1773
20 g-5 mg	30390138	1840
20 g-1 mg	30390137	2126
500 mg-10 mg	30390136	1121
500 mg-1 mg	30390135	1392



ASTM Class 1 Weight Sets

Adjusted to meet ASTM Class 1 Tolerances

- Can be used as a reference standard in calibrating other weights and is appropriate for calibrating high-precision analytical balances with a readability as low as 0.1 mg to 0.01 mg.
- Weights are designed so the specifications on surface finish, markings, construction, material density, and magnetic properties become more restrictive as the weight tolerances decrease.
- Weight sets 500 g and below include a polycarbonate case. Weight sets where the largest weight is 1 kg and above are supplied in a tough, lightweight, rugged case, designed to protect your weight set under any shipping circumstance.



Without Certificate		
Model	Item No.	Price USD
50 kg-1 g	30391360	20978
50 kg-1 mg	30391359	21425
30 kg-1 g	30391358	14728
30 kg-1 mg	30391357	15250
25 kg-1 g	30391356	14432
25 kg-1 mg	30391355	14878
20 kg-1 g	30391354	9374
20 kg-1 mg	30391353	10861
10 kg-1 g	30391352	7367
10 kg-1 mg	30391351	7735
5 kg-1 g	30391350	5023
5 kg-1 mg	30391349	5505
2 - 2 kg-1 g	30390054	4019
2 - 2 kg-1 mg	30390053	4313
2 kg-1 g	30391348	3272
2 kg-1 mg	30391347	3869
1 kg-1 g	30391346	2455
1 kg-1 mg	30391345	3012
500 g-1 g	30391344	1667
500 g-1 mg	30391343	2261
2 - 200 g-1 g	80781033	882
2 - 200 g-1 mg	80781031	1333
200 g-1 g	30391342	812
200 g-1 mg	30391341	1216
100 g-1 g	80781029	694
100 g-100 mg	30391340	821
100 g-10 mg	30391339	1012
100 g-5 mg	30391338	1068
100 g-1 mg	80781027	1154
50 g-1 g	80781025	670
50 g-100 mg	30391337	812
50 g-10 mg	30391336	935
50 g- 5 mg	30391335	1001
50 g-1 mg	80781023	1106
20 g-1 g	30391334	627
20 g-100 mg	30391333	754
20 g-10 mg	30391332	895
20 g-5 mg	30391331	931
20 g-1 mg	30391330	1082
500 mg-10 mg	30391329	455
500 mg-1 mg	80781021	635

Traceable Certificate		
Model	Item No.	Price USD
50 kg-1 g	30391574	22858
50 kg-1 mg	30391573	23737
30 kg-1 g	30391572	16262
30 kg-1 mg	30391571	16996
25 kg-1 g	30391570	14800
25 kg-1 mg	30391569	15531
20 kg-1 g	30391568	10403
20 kg-1 mg	30391567	11210
10 kg-1 g	30391566	7621
10 kg-1 mg	30391565	8427
5 kg-1 g	30391564	5643
5 kg-1 mg	30391563	6375
2 - 2 kg-1 g	30390060	4615
2 - 2 kg-1 mg	30390059	5421
2 kg-1 g	30391562	3627
2 kg-1 mg	30391561	4389
1 kg-1 g	30391560	2886
1 kg-1 mg	30391559	3648
500 g-1 g	30391558	2097
500 g-1 mg	30391557	2902
2 - 200 g-1 g	30390058	1274
2 - 200 g-1 mg	30390057	2050
200 g-1 g	30391556	1060
200 g-1 mg	30391555	1834
100 g-1 g	30391554	877
100 g-100 mg	30391553	1086
100 g-10 mg	30391552	1424
100 g-5 mg	30391551	1442
100 g-1 mg	30391550	1628
50 g-1 g	30391549	913
50 g-100 mg	30391548	1083
50 g-10 mg	30391547	1292
50 g- 5 mg	30391546	1376
50 g-1 mg	30391545	1560
20 g-1 g	30391544	743
20 g-100 mg	30391543	916
20 g-10 mg	30391542	1242
20 g-5 mg	30391541	1177
20 g-1 mg	30391540	1459
500 mg-10 mg	30391539	731
500 mg-1 mg	30391538	912

NVLAP Certificate		
Model	Item No.	Price USD
50 kg-1 g	30391392	23297
50 kg-1 mg	30391391	24145
30 kg-1 g	30391390	16723
30 kg-1 mg	30391389	17677
25 kg-1 g	30391388	15149
25 kg-1 mg	30391387	16066
20 kg-1 g	30391386	10819
20 kg-1 mg	30391385	11824
10 kg-1 g	30391384	8072
10 kg-1 mg	30391383	9055
5 kg-1 g	30391382	6037
5 kg-1 mg	30391381	7032
2 - 2 kg-1 g	30390056	4996
2 - 2 kg-1 mg	30390055	5992
2 kg-1 g	30391380	3978
2 kg-1 mg	30391379	4975
1 kg-1 g	30391378	3212
1 kg-1 mg	30391377	4206
500 g-1 g	30391376	2398
500 g-1 mg	30391375	3535
2 - 200 g-1 g	80781034	1473
2 - 200 g-1 mg	80781032	2623
200 g-1 g	30391374	1292
200 g-1 mg	30391373	2417
100 g-1 g	80781030	1211
100 g-100 mg	30391372	1532
100 g-10 mg	30391371	1956
100 g-5 mg	30391370	1773
100 g-1 mg	80781028	2272
50 g-1 g	80781026	1160
50 g-100 mg	30391369	1459
50 g-10 mg	30391368	1822
50 g- 5 mg	30391367	1891
50 g-1 mg	80781024	2126
20 g-1 g	30391366	877
20 g-100 mg	30391365	1208
20 g-10 mg	30391364	1547
20 g-5 mg	30391363	1473
20 g-1 mg	30391362	1921
500 mg-10 mg	30391361	976
500 mg-1 mg	80781022	1162

ASTM Class 4 Weight Sets Adjusted to meet ASTM Class 4 Tolerances

- Can be used for calibration of semi-analytical balances and for student use.
- Weights are designed so the specifications on surface finish, markings, construction, material density, and magnetic properties become more restrictive as the weight tolerances decrease.
- Weight sets 500 g and below include a polycarbonate case. Weight sets where the largest weight is 1 kg and above are supplied in a tough, lightweight, rugged case, designed to protect your weight set under any shipping circumstance.



Without Certificate		
Model	Item No.	Price USD
50 kg - 1 g	30391228	17257
50 kg - 1 mg	30391227	17517
30 kg - 1 g	30391226	12050
30 kg - 1 mg	30391225	12534
25 kg - 1 g	30391224	11681
25 kg - 1mg	30391223	12276
20 kg - 1 g	30391222	7701
20 kg - 1 mg	30391221	9032
10 kg - 1 g	30391220	6027
10 kg -1 mg	30391219	6355
5 kg -1 g	30391218	4152
5 kg - 1 mg	30391217	4508
2 - 2kg-1 g	30390048	3272
2 - 2 kg-1 mg	30390047	3853
2 kg - 1 g	30391216	2707
2 kg - 1 mg	30391215	3156
1 kg - 1 g	30391214	2038
1 kg - 1 mg	30391213	2501
500 g - 1 g	30391212	1363
500 g - 1 mg	30391211	1755
2 - 200 g - 1 g	30390046	518
2 - 200 g - 1 mg	30390045	792
200 g - 1 g	30391210	443
200 g - 1 mg	30391209	632
100 g - 1 g	30391208	496
100 g - 100 mg	30391207	474
100 g - 10 mg	30391206	549
100 g - 5 mg	30391205	587
100 g - 1 mg	80780101	700
50 g - 1 g	30391204	399
50 g - 100 mg	30391203	469
50 g - 10 mg	30391202	599
50 g - 5 mg	30391201	549
50 g - 1 mg	80780111	620
20 g - 1 g	30391200	366
20 g - 100 mg	30391199	436
20 g - 10 mg	30391198	483
20 g - 5 mg	30391197	527
20 g - 1 mg	30391196	587
500 mg - 10 mg	30391195	225
500 mg - 1 mg	80780100	327

Traceable Certificate		
Model	Item No.	Price USD
50 kg - 1 g	30391075	19780
50 kg - 1 mg	30391074	20511
30 kg - 1 g	30391073	14022
30 kg - 1 mg	30391072	14652
25 kg - 1 g	30391071	12822
25 kg - 1mg	30391070	13482
20 kg - 1 g	30391069	9012
20 kg - 1 mg	30391068	9670
10 kg - 1 g	30391067	6593
10 kg -1 mg	30391066	7253
5 kg -1 g	30391065	4838
5 kg - 1 mg	30391064	5567
2 - 2kg-1 g	30390044	4029
2 - 2 kg-1 mg	30390043	4688
2 kg - 1 g	30391063	3151
2 kg - 1 mg	30391062	3788
1 kg - 1 g	30391061	2490
1 kg - 1 mg	30391060	3151
500 g - 1 g	30391059	1816
500 g - 1 mg	30391058	2481
2 - 200 g - 1 g	30390042	810
2 - 200 g - 1 mg	30390041	1126
200 g - 1 g	30391057	678
200 g - 1 mg	30391056	1026
100 g - 1 g	30391055	657
100 g - 100 mg	30391054	662
100 g - 10 mg	30391053	810
100 g - 5 mg	30391052	885
100 g - 1 mg	30391051	1131
50 g - 1 g	30391050	540
50 g - 100 mg	30391049	678
50 g - 10 mg	30391048	947
50 g - 5 mg	30391047	877
50 g - 1 mg	30391046	933
20 g - 1 g	30391045	462
20 g - 100 mg	30391044	588
20 g - 10 mg	30391043	678
20 g - 5 mg	30391042	717
20 g - 1 mg	30391041	890
500 mg - 10 mg	30391040	440
500 mg - 1 mg	30391039	465

NVLAP Certificate		
Model	Item No.	Price USD
50 kg - 1 g	30391262	20491
50 kg - 1 mg	30391261	20981
30 kg - 1 g	30391260	14483
30 kg - 1 mg	30391259	15317
25 kg - 1 g	30391258	13157
25 kg - 1mg	30391257	13993
20 kg - 1 g	30391256	9414
20 kg - 1 mg	30391255	10331
10 kg - 1 g	30391254	6999
10 kg -1 mg	30391253	7867
5 kg -1 g	30391252	5246
5 kg - 1 mg	30391251	5978
2 - 2kg-1 g	30390052	4316
2 - 2 kg-1 mg	30390051	5325
2 kg - 1 g	30391250	3494
2 kg - 1 mg	30391249	4418
1 kg - 1 g	30391248	2916
1 kg - 1 mg	30391247	3664
500 g - 1 g	30391246	2125
500 g - 1 mg	30391245	2952
2 - 200 g - 1 g	30390050	1051
2 - 200 g - 1 mg	30390049	1760
200 g - 1 g	30391244	917
200 g - 1 mg	30391243	1619
100 g - 1 g	30391242	817
100 g - 100 mg	30391241	1110
100 g - 10 mg	30391240	1326
100 g - 5 mg	30391239	1376
100 g - 1 mg	80850265	1560
50 g - 1 g	30391238	751
50 g - 100 mg	30391237	967
50 g - 10 mg	30391236	1292
50 g - 5 mg	30391235	1417
50 g - 1 mg	80850264	1459
20 g - 1 g	30391234	662
20 g - 100 mg	30391233	778
20 g - 10 mg	30391232	1141
20 g - 5 mg	30391231	950
20 g - 1 mg	30391230	1310
500 mg - 10 mg	30391229	712
500 mg - 1 mg	80850263	783

ASTM Class 1 Electronic Balance Weights

Adjusted to meet ASTM Class 1 Tolerances

- Can be used to check or verify the accuracy of your balance and/or scale between calibrations.
- Weights are available in a cylindrical design up through 5 kg and a stackable grip-handle design from 5 kg through 30 kg for all necessary testing, calibration and adjustment of electronic scales and balances.
- Weights 10 g through 10 kg are supplied in a high quality polycarbonate case; a nylon glove is included to protect weights during use.



Without Certificate		
Model	Item No.	Price USD
30 kg grip	80781007	2031
25 kg grip	30391488	1732
24 kg grip	30391487	1682
20 kg grip	80781005	1482
16 kg grip	30391485	1346
10 kg grip	80781003	963
8 kg grip	30391483	929
5 kg grip	80781001	702
5 kg cyl	30391481	447
4 kg grip	30391480	652
4 kg cyl	80780027	382
3 kg cyl	30391478	297
2 kg cyl	80780024	202
1500 g cyl	30391476	183
1000 g cyl	80780021	162
600 g cyl	30391474	152
500 g cyl	80780029	131
400 g cyl	80780026	129
300 g cyl	30391471	107
200 g cyl	80780023	96
160 g cyl	30391469	101
150 g cyl	30391468	93
100 g cyl	80780020	81
80 g cyl	30391466	90
70 g cyl	30391465	82
60 g cyl	30391464	78
50 g cyl	80780028	72
40 g cyl	80780025	72
30 g cyl	30391461	72
20 g cyl	80780022	72
10 g cyl	30391459	72

Traceable Certificate		
Model	Item No.	Price USD
30 kg grip	30391520	2206
25 kg grip	30391519	1804
24 kg grip	30391518	1767
20 kg grip	30391517	1532
16 kg grip	30391516	1390
10 kg grip	30391515	1056
8 kg grip	30391514	998
5 kg grip	30391513	748
5 kg cyl	30391512	494
4 kg grip	30391511	682
4 kg cyl	30391510	462
3 kg cyl	30391509	368
2 kg cyl	30391508	263
1500 g cyl	30391507	265
1000 g cyl	30391506	206
600 g cyl	30391505	202
500 g cyl	30391504	179
400 g cyl	30391503	176
300 g cyl	30391502	159
200 g cyl	30391501	156
160 g cyl	30391500	158
150 g cyl	30391499	158
100 g cyl	30391498	108
80 g cyl	30391497	125
70 g cyl	30391496	125
60 g cyl	30391495	125
50 g cyl	30391494	104
40 g cyl	30391493	104
30 g cyl	30391492	104
20 g cyl	30391491	104
10 g cyl	30391490	104

NVLAP Certificate		
Model	Item No.	Price USD
30 kg grip	80781008	2303
25 kg grip	30391537	1841
24 kg grip	30391536	1770
20 kg grip	80781006	1552
16 kg grip	30391535	1420
10 kg grip	80781004	1092
8 kg grip	30391534	1035
5 kg grip	80781002	842
5 kg cyl	30391533	574
4 kg grip	30391532	798
4 kg cyl	80850275	530
3 kg cyl	30391531	446
2 kg cyl	80850272	322
1500 g cyl	30391530	334
1000 g cyl	80850269	260
600 g cyl	30391529	270
500 g cyl	80850277	249
400 g cyl	80850274	237
300 g cyl	30391528	224
200 g cyl	80850271	208
160 g cyl	30391527	227
150 g cyl	30391526	225
100 g cyl	80850268	156
80 g cyl	30391525	156
70 g cyl	30391524	156
60 g cyl	30391523	156
50 g cyl	80850276	156
40 g cyl	80850273	156
30 g cyl	30391522	156
20 g cyl	80850270	156
10 g cyl	30391521	156

ASTM Class 4 Electronic Balance Weights

Adjusted to meet ASTM Class 4 Tolerances

- Can be used to check or verify the accuracy of your balance and/or scale between calibrations.
- Weights are available in a cylindrical design up through 5 kg and a stackable grip-handle design from 5 kg through 30 kg for all necessary testing, calibration and adjustment of electronic scales and balances.
- Weights 10 g through 10 kg are supplied in a high quality polycarbonate case; a nylon glove is included to protect weights during use.



Without Certificate		
Model	Item No.	Price USD
30 kg grip	30391139	1397
25 kg grip	30391138	1245
24 kg grip	30391137	1184
20 kg grip	30391136	1014
16 kg grip	30391135	887
10 kg grip	30391134	660
8 kg grip	30391133	777
5 kg grip	30391132	438
5 kg cyl	30391131	348
4 kg grip	30391130	480
4 kg cyl	30391129	338
3 kg cyl	30391128	269
2 kg cyl	80780145	169
1500 g cyl	30391126	169
1000 g cyl	80780143	136
600 g cyl	30391124	140
500 g cyl	80780141	102
400 g cyl	80780139	116
300 g cyl	80780137	90
200 g cyl	80780135	80
160 g cyl	30391119	95
150 g cyl	30391118	75
100 g cyl	80780133	68
80 g cyl	30391116	80
70 g cyl	30391115	78
60 g cyl	30391114	73
50 g cyl	30391113	64
40 g cyl	30391112	64
30 g cyl	30391111	64
20 g cyl	30391110	64
10 g cyl	30391109	64

Traceable Certificate		
Model	Item No.	Price USD
30 kg grip	30391170	1575
25 kg grip	30391169	1249
24 kg grip	30391168	1213
20 kg grip	30391167	1066
16 kg grip	30391166	983
10 kg grip	30391165	736
8 kg grip	30391164	767
5 kg grip	30391163	495
5 kg cyl	30391162	392
4 kg grip	30391161	495
4 kg cyl	30391160	396
3 kg cyl	30391159	339
2 kg cyl	30391158	206
1500 g cyl	30391157	229
1000 g cyl	30391156	165
600 g cyl	30391155	179
500 g cyl	30391154	143
400 g cyl	30391153	136
300 g cyl	30391152	125
200 g cyl	30391151	119
160 g cyl	30391150	130
150 g cyl	30391149	136
100 g cyl	30391148	80
80 g cyl	30391147	104
70 g cyl	30391146	104
60 g cyl	30391145	104
50 g cyl	30391144	88
40 g cyl	30391143	88
30 g cyl	30391142	88
20 g cyl	30391141	88
10 g cyl	30391140	88

NVLAP Certificate		
Model	Item No.	Price USD
30 kg grip	30391194	1581
25 kg grip	30391193	1328
24 kg grip	30391192	1265
20 kg grip	30391191	1108
16 kg grip	30391190	985
10 kg grip	30391189	760
8 kg grip	30391188	864
5 kg grip	30391187	518
5 kg cyl	30391186	442
4 kg grip	30391185	575
4 kg cyl	30391184	412
3 kg cyl	30391183	349
2 kg cyl	80780146	250
1500 g cyl	30391182	305
1000 g cyl	80780144	209
600 g cyl	30391181	207
500 g cyl	80780142	198
400 g cyl	80780140	184
300 g cyl	80780138	176
200 g cyl	80780136	170
160 g cyl	30391180	190
150 g cyl	30391179	190
100 g cyl	80780134	129
80 g cyl	30391178	129
70 g cyl	30391177	129
60 g cyl	30391176	129
50 g cyl	30391175	122
40 g cyl	30391174	122
30 g cyl	30391173	122
20 g cyl	30391172	122
10 g cyl	30391171	122



OIML E1 & E2 Individual Weights

Manufactured to meet OIML R 111 weight specifications

- OIML R 111 weight specifications are designed so the specifications on surface finish, markings, construction, material density and magnetic properties become more restrictive as weight tolerances decrease in order to enable the weight to maintain its tolerance over time.
- Weights 1 g and above are one-piece construction. Weights 1 g and larger are cylindrical in shape with a tapered neck for easy gripping. They are perfectly flat on top to stack easily on center. Weight bottoms are slightly recessed to expose the smallest possible area to wear.
- Individual weights 1 mg through 10 kg are supplied in durable polycarbonate cases. Case lids lock tightly to ensure that your weight is held securely and kept clean and dust free.



E1 Weights NVLAP		
Model	Item No.	Price USD
50 kg	30390927	9915
20 kg	30390928	4513
10 kg	30390929	2969
5 kg	30390930	2199
2 kg	30390931	1605
1 kg	30390932	1093
500 g	30390933	896
200 g	30390934	731
100 g	30390935	645
50 g	30390936	578
20 g	30390937	547
10 g	30390938	522
5 g	30390939	504
2 g	30390940	486
1 g	30390941	486
500 mg	30390942	263
200 mg	30390943	263
100 mg	30390944	263
50 mg	30390945	263
20 mg	30390946	263
10 mg	30390947	263
5 mg	30390948	263
2 mg	30390949	263
1 mg	30390950	263

E2 Weights NVLAP		
Model	Item No.	Price USD
50 kg	30390903	8530
20 kg	80780306	2769
10 kg	80780305	2142
5 kg	80780304	1068
2 kg	80780303	752
1 kg	80780302	526
500 g	80780301	384
200 g	80780300	265
100 g	80780299	176
50 g	80780298	150
20 g	80780297	137
10 g	80780296	137
5 g	80780295	126
2 g	80780294	126
1 g	80780293	126
500 mg	80780292	118
200 mg	80780291	118
100 mg	80780290	118
50 mg	80780289	118
20 mg	80780288	118
10 mg	80780287	118
5 mg	80780286	118
2 mg	80780285	118
1 mg	80780284	118

OIML F1 & F2 Individual Weights

Manufactured to meet OIML R 111 weight specifications

- OIML R 111 weight specifications are designed so the specifications on surface finish, markings, construction, material density and magnetic properties become more restrictive as weight tolerances decrease in order to enable the weight to maintain its tolerance over time.
- Weights 1 g and above are two-piece construction. OIML Calibration Weights 1 g and larger are cylindrical in shape with a tapered neck for easy gripping. They are perfectly flat on top to stack easily on center. Weight bottoms are slightly recessed to expose the smallest possible area to wear.
- Individual weights 1 mg through 10 kg are supplied in durable polycarbonate cases. Case lids lock tightly to ensure that your weight is held securely and kept clean and dust free.



F1 Weights Without Certificate		
Model	Item No.	Price USD
50 kg	80780330	6331
20 kg	80780329	2268
10 kg	80780328	1633
5 kg	80780327	793
2 kg	80780326	469
1 kg	80780325	324
500 g	80780324	199
200 g	80780323	146
100 g	80780322	105
50 g	80780321	91
20 g	80780320	87
10 g	80780319	84
5 g	80780318	81
2 g	80780317	81
1 g	80780316	81
500 mg	80780315	37
200 mg	80780314	37
100 mg	80780313	37
50 mg	80780312	37
20 mg	80780311	37
10 mg	80780310	37
5 mg	80780309	37
2 mg	80780308	37
1 mg	80780307	37

F1 Weights NVLAP Certificate		
Model	Item No.	Price USD
50 kg	30390901	6272
20 kg	80780353	2386
10 kg	80780352	1746
5 kg	80780351	909
2 kg	80780350	590
1 kg	80780349	438
500 g	80780348	303
200 g	80780347	236
100 g	80780346	146
50 g	80780345	132
20 g	80780344	132
10 g	80780343	132
5 g	80780342	119
2 g	80780341	119
1 g	80780340	119
500 mg	80780339	84
200 mg	80780338	84
100 mg	80780337	84
50 mg	80780336	84
20 mg	80780335	84
10 mg	80780334	84
5 mg	80780333	84
2 mg	80780332	84
1 mg	80780331	84

F2 Weights Without Certificate		
Model	Item No.	Price USD
50 kg	30390853	4439
20 kg	30390854	1955
10 kg	30390855	1158
5 kg	30390856	498
2 kg	30390857	331
1 kg	30390858	224
500 g	30390859	141
200 g	30390860	106
100 g	30390861	75
50 g	30390862	69
20 g	30390863	62
10 g	30390864	54
5 g	30390865	55
2 g	30390866	55
1 g	30390867	53
500 mg	30390868	24
200 mg	30390869	24
100 mg	30390870	24
50 mg	30390871	24
20 mg	30390872	24
10 mg	30390873	24
5 mg	30390874	20
2 mg	30390875	19
1 mg	30390876	20

F2 Weights NVLAP Certificate		
Model	Item No.	Price USD
50 kg	30390877	4555
20 kg	30390878	2133
10 kg	30390879	1285
5 kg	30390880	626
2 kg	30390881	416
1 kg	30390882	308
500 g	30390883	191
200 g	30390884	160
100 g	30390885	113
50 g	30390886	105
20 g	30390887	103
10 g	30390888	90
5 g	30390889	94
2 g	30390890	94
1 g	30390891	94
500 mg	30390892	66
200 mg	30390893	66
100 mg	30390894	66
50 mg	30390895	66
20 mg	30390896	66
10 mg	30390897	66
5 mg	30390898	59
2 mg	30390899	59
1 mg	30390900	59



OIML E1 & E2 Weight Sets

Manufactured to meet OIML R 111 weight specifications

- OIML R 111 weight specifications are designed so the specifications on surface finish, markings, construction, material density and magnetic properties become more restrictive as weight tolerances decrease in order to enable the weight to maintain its tolerance over time.
- Weights 1 g and above are one-piece construction. Weights 1 g and larger are cylindrical in shape with a tapered neck for easy gripping. They are perfectly flat on top to stack easily on center. Weight bottoms are slightly recessed to expose the smallest possible area to wear.
- Weight sets 500 g and below include a polycarbonate case. Weight sets where the largest weight is 1 kg and above are supplied in a tough, lightweight, rugged case, designed to protect your weight set under any shipping circumstance.



E1 Sets NVLAP		
Model	Item No.	Price USD
50 kg - 1 g	30390904	37412
50 kg - 1 mg	30390905	38600
20 kg - 1 g	30390906	17815
20 kg - 1 mg	30390907	19004
10 kg - 1 g	30390908	14252
10 kg - 1 mg	30390909	14727
5 kg-1 kg	30390910	6652
5 kg - 1 g	30390911	10590
5 kg - 1 mg	30390912	11402
2 kg - 1 g	30390913	6652
2 kg - 1 mg	30390914	8196
(2) 2 kg - 1 g	30390037	7958
(2) 2 kg - 1 mg	30390038	9501
1 kg - 1 g	30390915	5582
1 kg - 1 mg	30390916	7008
500 g - 1 g	30390917	4751
500 g - 1 mg	30390918	6414
200 g - 1 g	30390919	4039
200 g - 1 mg	30390920	4988
(2) 200 g - 1 g	30390039	4394
(2) 200 g - 1 mg	30390040	5345
100 g - 1 g	30390921	3683
100 g - 1 mg	30390922	4988
50 g - 1 g	30390923	3207
50 g - 1 mg	30390924	4157
5 g - 1 mg	30390925	3207
500 mg - 1 mg	30390926	2019

E2 Sets NVLAP		
Model	Item No.	Price USD
50 kg - 1 g	80780407	21498
50 kg - 1 mg	80780406	21853
20 kg - 1 g	80780405	9977
20 kg - 1 mg	80780404	10451
10 kg - 1 g	80780403	7958
10 kg - 1 mg	80780402	8196
5 kg-1 kg	80780401	3381
5 kg - 1 g	80780400	5464
5 kg - 1 mg	80780399	6295
2 kg - 1 g	80780398	3801
2 kg - 1 mg	80780397	4633
(2) 2 kg - 1 g	80780396	4157
(2) 2 kg - 1 mg	80780395	4633
1 kg - 1 g	80780394	2732
1 kg - 1 mg	80780393	3493
500 g - 1 g	80780392	2376
500 g - 1 mg	80780391	2852
200 g - 1 g	80780390	1544
200 g - 1 mg	80780389	2256
(2) 200 g - 1 g	80780388	2138
(2) 200 g - 1 mg	80780387	2613
100 g - 1 g	80780386	1218
100 g - 1 mg	80780385	1900
50 g - 1 g	80780384	1068
50 g - 1 mg	80780383	1781
5 g - 1 mg	80780382	1395
500 mg - 1 mg	80780381	1092

OIML F1 & F2 Weight Sets

Manufactured to meet OIML R 111 weight specifications



- OIML R 111 weight specifications are designed so the specifications on surface finish, markings, construction, material density and magnetic properties become more restrictive as weight tolerances decrease in order to enable the weight to maintain its tolerance over time.
- Weights 1 g and above are two-piece construction. OIML Calibration Weights 1 g and larger are cylindrical in shape with a tapered neck for easy gripping. They are perfectly flat on top to stack easily on center. Weight bottoms are slightly recessed to expose the smallest possible area to wear.
- Weight sets 500 g and below include a polycarbonate case. Weight sets where the largest weight is 1 kg and above are supplied in a tough, lightweight, rugged case, designed to protect your weight set under any shipping circumstance.

F1 Weights Without Certificate		
Model	Item No.	Price USD
50 kg - 1 g	80780434	14274
50 kg - 1 mg	80780433	13777
20 kg - 1 g	80780432	6951
20 kg - 1 mg	80780431	7323
10 kg - 1 g	80780430	4470
10 kg - 1 mg	80780429	4965
5 kg - 1 g	80780428	1738
5 kg - 1 mg	80780427	2855
5 kg - 1 mg	80780426	3041
2 kg - 1 g	80780425	1987
2 kg - 1 mg	80780424	2298
(2) 2 kg - 1 g	80780423	2174
(2) 2 kg - 1 mg	80780422	3047
1 kg - 1 g	80780421	1304
1 kg - 1 mg	80780420	1613
500 g - 1 g	80780419	992
500 g - 1 mg	80780418	1241
200 g - 1 g	80780417	723
200 g - 1 mg	80780416	968
(2) 200 g - 1 g	80780415	718
(2) 200 g - 1 mg	80780414	992
100 g - 1 g	80780413	559
100 g - 1 mg	80780412	805
50 g - 1 g	80780411	495
50 g - 1 mg	80780410	744
5 g - 1 mg	80780409	495
500 mg - 1 mg	80780408	342

F1 Weights NVLAP Certificate		
Model	Item No.	Price USD
50 kg - 1 g	80780461	15440
50 kg - 1 mg	80780460	16034
20 kg - 1 g	80780459	8313
20 kg - 1 mg	80780458	8907
10 kg - 1 g	80780457	4751
10 kg - 1 mg	80780456	5227
5 kg - 1 g	80780455	2257
5 kg - 1 g	80780454	3059
5 kg - 1 mg	80780453	4741
2 kg - 1 g	80780452	2257
2 kg - 1 mg	80780451	2613
(2) 2 kg - 1 g	80780450	2613
(2) 2 kg - 1 mg	80780449	4066
1 kg - 1 g	80780448	1544
1 kg - 1 mg	80780447	2801
500 g - 1 g	80780446	1566
500 g - 1 mg	80780445	1543
200 g - 1 g	80780444	981
200 g - 1 mg	80780443	1901
(2) 200 g - 1 g	80780442	1158
(2) 200 g - 1 mg	80780441	2131
100 g - 1 g	80780440	653
100 g - 1 mg	80780439	1100
50 g - 1 g	80780438	836
50 g - 1 mg	80780437	1022
5 g - 1 mg	80780436	758
500 mg - 1 mg	80780435	717

F2 Weights Without Certificate		
Model	Item No.	Price USD
50 kg - 1 g	30390807	11915
50 kg - 1 mg	30390808	12164
20 kg - 1 g	30390809	6454
20 kg - 1 mg	30390810	6951
10 kg - 1 g	30390811	4221
10 kg - 1 mg	30390812	4633
5 kg - 1 g	30390813	1862
5 kg - 1 g	30390814	1553
5 kg - 1 mg	30390815	2562
2 kg - 1 g	30390816	1304
2 kg - 1 mg	30390817	1794
(2) 2 kg - 1 g	30390029	1428
(2) 2 kg - 1 mg	30390030	1614
1 kg - 1 g	30390818	870
1 kg - 1 mg	30390819	1386
500 g - 1 g	30390820	833
500 g - 1 mg	30390821	994
200 g - 1 g	30390822	694
200 g - 1 mg	30390823	847
(2) 200 g - 1 g	30390031	620
(2) 200 g - 1 mg	30390032	807
100 g - 1 g	30390824	452
100 g - 1 mg	30390825	641
50 g - 1 g	30390826	478
50 g - 1 mg	30390827	615
5 g - 1 mg	30390828	362
500 mg - 1 mg	30390829	305

F2 Weights NVLAP Certificate		
Model	Item No.	Price USD
50 kg - 1 g	30390830	12115
50 kg - 1 mg	30390831	12708
20 kg - 1 g	30390832	6830
20 kg - 1 mg	30390833	7126
10 kg - 1 g	30390834	3919
10 kg - 1 mg	30390835	4394
5 kg - 1 g	30390836	2019
5 kg - 1 g	30390837	2019
5 kg - 1 mg	30390838	2858
2 kg - 1 g	30390839	1634
2 kg - 1 mg	30390840	2326
(2) 2 kg - 1 g	30390033	2257
(2) 2 kg - 1 mg	30390034	2613
1 kg - 1 g	30390841	1129
1 kg - 1 mg	30390842	1863
500 g - 1 g	30390843	1073
500 g - 1 mg	30390844	1188
200 g - 1 g	30390845	707
200 g - 1 mg	30390846	1313
(2) 200 g - 1 g	30390035	981
(2) 200 g - 1 mg	30390036	1158
100 g - 1 g	30390847	505
100 g - 1 mg	30390848	862
50 g - 1 g	30390849	558
50 g - 1 mg	30390850	818
5 g - 1 mg	30390851	608
500 mg - 1 mg	30390852	504



ASTM Class 6 Weights - Cylindrical

Adjusted to Meet or Exceed ASTM Class 6 Tolerances

- Weights from 1 g to 2 kg are Stainless Steel and Weights 500 mg and below are Aluminum.
- Weight Sets include a Weight Case.
- Individual Weights do not include a case



Cylindrical Weights

Model	Item No.	Price USD
Weight Set, 500 mg-1 mg, ASTM 6, Cyl	80850110	71
Weight Set, 50 g-10 mg, ASTM 6, Cyl	80850111	167
Weight Set, 100 g-1 mg, ASTM 6, Cyl	80850112	201
Weight Set, 200 g-1 mg, ASTM 6, Cyl	80850113	246
Weight Set, 500 g-1 g, ASTM 6, Cyl	80850114	315
Weight Set, 1 kg-1 g, ASTM 6, Cyl	80850115	432
Weight Set, 2 kg-1 g, ASTM 6, Cyl	80850116	657
Weight Set, 50 g-1 g, ASTM 6, Cyl	80850117	138
Weight, 1 g, ASTM 6, Cyl, Body	80850118	14
Weight, 2 g, ASTM 6, Cyl, Body	80850119	14
Weight, 5 g, ASTM 6, Cyl, Body	80850120	15
Weight, 10 g, ASTM 6, Cyl, Body	80850121	16
Weight, 20 g, ASTM 6, Cyl, Body	80850122	19
Weight, 50 g, ASTM 6, Cyl, Body	80850123	21
Weight, 100 g, ASTM 6, Cyl, Body	80850124	30
Weight, 200 g, ASTM 6, Cyl, Body	80850125	40
Weight, 300 g, ASTM 6, Cyl, Body	80850126	51
Weight, 500 g, ASTM 6, Cyl, Body	80850127	63
Weight, 1 kg, ASTM 6, Cyl, Body	80850128	111
Weight, 2 kg, ASTM 6, Cyl, Body	80850129	176

Hooked Weights

Model	Item No.	Price USD
Weight Set, 1 kg-10 g, ASTM 6, Hooked	80850130	164
Weight, 10 g, Hooked	80850131	19
Weight, 20 g, Hooked	80850132	19
Weight, 50 g, Hooked	80850133	20
Weight, 100 g, Hooked	80850134	21
Weight, 200 g, Hooked	80850135	31
Weight, 500 g, Hooked	80850136	42
Weight, 1 kg, Hooked	80850137	80

Slotted Weights

Model	Item No.	Price USD
Weight Set, Slotted 500 g-10 g	80850138	135
Weight Set, Slotted 500 g-1 g	80850139	173
Weight Set, 1 g, ASTM 6, Slotted	80850140	21
Weight Set, 2 g, ASTM 6, Slotted	80850141	21
Weight Set, 5 g, ASTM 6, Slotted	80850142	21
Weight Set, 10 g, ASTM 6, Slotted	80850143	21
Weight Set, 20 g, ASTM 6, Slotted	80850144	21
Weight Set, 50 g, ASTM 6, Slotted	80850145	21
Weight Set, 100 g, ASTM 6, Slotted	80850146	23
Weight Set, 200 g, ASTM 6, Slotted	80850147	29
Weight Set, 500 g, ASTM 6, Slotted	80850148	49
Weight, 50 g, Hanger	80850149	29

NIST Class F Cast Iron Grip Weights

Manufactured to meet NIST Handbook 105-1 specifications

- Cast Iron Grip Handle Weights are primarily used to test commercial weighing devices by state and local weights and measures officials, device installers, and service technicians.
- Cast Iron Grip Handle Weights larger than 5 kg/10 lb are legal-for-trade, which means their design is acceptable for use in checking weighing devices where the price of the item being purchased is based on its weight.
- All surfaces are smooth and free of scratches, dents and pores as outlined in NIST Handbook 105-1.



Without Certificate		
Model	Item No.	Price USD
5000 lb	30391735	14919
3000 lb	30391734	9358
2500 lb	30391733	8400
2000 lb	30391732	7426
1500 lb	30391731	6731
1250 lb	30391730	5622
1000 lb	30391729	2682
500 lb	30391728	1686
250 lb	30391727	1546
200 lb	30391726	1347
100 lb	80850311	592
50 lb	80850310	167
30 lb	30391723	184
25 lb	80850309	119
20 lb	80850308	94
10 lb	80850307	78
5 lb	80850306	60

Traceable Certificate		
Model	Item No.	Price USD
5000 lb	30391764	16432
3000 lb	30391763	9676
2500 lb	30391762	8936
2000 lb	30391761	7587
1500 lb	30391760	6257
1250 lb	30391759	5843
1000 lb	30391758	3223
500 lb	30391757	2177
250 lb	30391756	1829
200 lb	30391755	1609
100 lb	30391754	828
50 lb	30391753	219
30 lb	30391752	198
25 lb	30391751	185
20 lb	30391750	152
10 lb	30391749	125
5 lb	30391748	110

NVLAP Certificate		
Model	Item No.	Price USD
5000 lb	30391781	16818
3000 lb	30391780	10415
2500 lb	30391779	9104
2000 lb	30391778	7716
1500 lb	30391777	6386
1250 lb	30391776	5974
1000 lb	30391775	3326
500 lb	30391774	2280
250 lb	30391773	1932
200 lb	30391772	1712
100 lb	30391771	893
50 lb	30391770	256
30 lb	30391769	239
25 lb	30391768	189
20 lb	30391767	189
10 lb	30391766	166
5 lb	30391765	142

Without Certificate		
Model	Item No.	Price USD
2000 kg	30391718	14586
1000 kg	30391717	7431
500 kg	30391716	3016
250 kg	30391715	1729
200 kg	30391714	1486
100 kg	30391713	1363
50 kg	80850305	599
25 kg	80850304	189
20 kg	80850303	141
10 kg	80850302	135
5 kg	80850301	82
2 kg	80850300	71

Traceable Certificate		
Model	Item No.	Price USD
2000 kg	30391747	15819
1000 kg	30391746	7813
500 kg	30391745	3610
250 kg	30391744	2065
200 kg	30391743	1867
100 kg	30391742	1641
50 kg	30391741	794
25 kg	30391740	251
20 kg	30391739	201
10 kg	30391738	156
5 kg	30391737	125
2 kg	30391736	108

NVLAP Certificate		
Model	Item No.	Price USD
2000 kg	30391706	16206
1000 kg	30391705	7943
500 kg	30391704	3713
250 kg	30391703	2169
200 kg	30391702	1969
100 kg	30391701	1744
50 kg	30391700	844
25 kg	30391699	293
20 kg	30391698	246
10 kg	30391697	198
5 kg	30391696	156
2 kg	30391695	141



NIST Class F Stainless Steel Individual Weights

Manufactured to meet NIST Handbook 105-1 specifications

- Stainless Steel Test Weights are primarily used to test commercial weighing devices by state and local weights and measures officials, device installers, and service technicians.
- Weights 5 kg /10 lb and below must be made of stainless steel of quality no lower than 300 series. Adjusting cavities are typically on the top of the weight and must be tamper resistant.
- All surfaces have a satin finish and conform to specifications in NIST Handbook 105-1.



Without Certificate		
Model	Item No.	Price USD
20 kg grip	30390593	822
16 kg grip	30390592	807
10 kg grip	30390591	596
8 kg grip	30390590	563
5 kg grip	30390589	350
5000 g	30390588	222
4000 g	30390587	204
3000 g	30390586	186
2000 g	30390585	131
1000 g	30390584	76
500 g	30390582	69
400 g	30390580	66
300 g	30390579	64
200 g	30390577	47
100 g	30390575	44
50 g	30390573	38
30 g	30390572	37
20 g	30390571	35
10 g	30390570	35
5 g	30390569	29
3 g	30390568	29
2 g	30390567	29
1 g	30390566	29

Traceable Certificate		
Model	Item No.	Price USD
20 kg grip	30390657	920
16 kg grip	30390656	902
10 kg grip	30390655	654
8 kg grip	30390654	618
5 kg grip	30390653	382
5000 g	30390652	267
4000 g	30390651	256
3000 g	30390650	243
2000 g	30390649	199
1000 g	30390648	155
500 g	30390646	145
400 g	30390644	143
300 g	30390643	120
200 g	30390641	104
100 g	30390639	94
50 g	30390637	91
30 g	30390636	90
20 g	30390635	90
10 g	30390634	90
5 g	30390633	83
3 g	30390632	83
2 g	30390631	83
1 g	30390630	83

NVLAP Certificate		
Model	Item No.	Price USD
20 kg grip	30390721	978
16 kg grip	30390720	969
10 kg grip	30390719	698
8 kg grip	30390718	679
5 kg grip	30390717	467
5000 g	30390716	327
4000 g	30390715	311
3000 g	30390714	296
2000 g	30390713	238
1000 g	30390712	184
500 g	30390710	173
400 g	30390708	173
300 g	30390707	142
200 g	30390705	127
100 g	30390703	112
50 g	30390701	112
30 g	30390700	103
20 g	30390699	103
10 g	30390698	103
5 g	30390697	93
3 g	30390696	93
2 g	30390695	93
1 g	30390694	93

Without Certificate		
Model	Item No.	Price USD
20 lb. grip	30390550	546
10 lb. grip	30390549	333
10 lb.	30390548	217
5 lb.	30390547	141
4 lb.	30390546	133
3 lb.	30390545	124
2 lb.	30390544	87
1 lb.	30390542	64
12 oz	30390540	53
8 oz	30390539	50
8 oz cube	30390538	113
4 oz	30390537	45
4 oz cube	30390536	101
2 oz	30390535	40
2 oz cube	30390534	91
1 oz	30390533	37

Traceable Certificate		
Model	Item No.	Price USD
20 lb. grip	30390614	591
10 lb. grip	30390613	461
10 lb.	30390612	278
5 lb.	30390611	218
4 lb.	30390610	211
3 lb.	30390609	204
2 lb.	30390608	171
1 lb.	30390606	156
12 oz	30390604	106
8 oz	30390603	102
8 oz cube	30390602	149
4 oz	30390601	99
4 oz cube	30390600	141
2 oz	30390599	96
2 oz cube	30390598	133
1 oz	30390597	94

NVLAP Certificate		
Model	Item No.	Price USD
20 lb. grip	30390678	666
10 lb. grip	30390677	567
10 lb.	30390676	334
5 lb.	30390675	261
4 lb.	30390674	256
3 lb.	30390673	249
2 lb.	30390672	207
1 lb.	30390670	191
12 oz	30390668	127
8 oz	30390667	127
8 oz cube	30390666	174
4 oz	30390665	118
4 oz cube	30390664	166
2 oz	30390663	117
2 oz cube	30390662	160
1 oz	30390661	112

NIST Class F Stainless Steel Weight Sets

Manufactured to meet NIST Handbook 105-1 specifications



- Stainless Steel Test Weights are primarily used to test commercial weighing devices by state and local weights and measures officials, device installers, and service technicians.
- Weights 5 kg /10 lb and below must be made of stainless steel of quality no lower than 300 series. Adjusting cavities are typically on the top of the weight and must be tamper resistant.
- All surfaces have a satin finish and conform to specifications in NIST Handbook 105-1.

Without Certificate		
Model	Item No.	Price USD
5000 g-1 mg	30390403	857
5000 g-1 mg	30390397	1493
5000 g-1 g	30390405	753
5000 g-1 g	30390399	1377
2000 g-1 mg	30390406	637
2000 g-1 g	30390408	559
2000 g-10 mg	30390407	605
2000 g-1 mg	30390400	1438
1000 g-1 g	30390411	476
500 g-1 g	30390414	373
100 g-1 mg	30390415	266
50 g-1 g	30390420	180
50 g-10 mg	30390419	227

Traceable Certificate		
Model	Item No.	Price USD
5000 g-1 mg	30390459	939
5000 g-1 mg	30390453	1592
5000 g-1 g	30390461	848
5000 g-1 g	30390455	1497
2000 g-1 mg	30390462	693
2000 g-1 g	30390464	632
2000 g-10 mg	30390463	665
2000 g-1 mg	30390456	1552
1000 g-1 g	30390467	562
500 g-1 g	30390470	480
100 g-1 mg	30390471	396
50 g-1 g	30390476	201
50 g-10 mg	30390475	358

NVLAP Certificate		
Model	Item No.	Price USD
5000 g-1 mg	30390515	1143
5000 g-1 mg	30390509	1717
5000 g-1 g	30390517	1027
5000 g-1 g	30390511	1629
2000 g-1 mg	30390518	841
2000 g-1 g	30390520	768
2000 g-10 mg	30390519	817
2000 g-1 mg	30390512	1669
1000 g-1 g	30390523	684
500 g-1 g	30390526	587
100 g-1 mg	30390527	490
50 g-1 g	30390532	252
50 g-10 mg	30390531	432

Without Certificate		
Model	Item No.	Price USD
10 lb-1/32 oz	30390384	813
10 lb-.001 lb	30390383	824
5 lb-.001 lb	30390373	1166
5 lb-.001 lb	30390375	1154
5 lb-1/32 oz	30390376	1136
5 lb-.05 oz	30390374	1165
5 lb-1/32 oz	30390387	550
4 oz-1/32 oz	30390379	213
.2 lb-.001 lb	30390381	229

Traceable Certificate		
Model	Item No.	Price USD
10 lb-1/32 oz	30390440	1246
10 lb-.001 lb	30390439	1260
5 lb-.001 lb	30390429	1467
5 lb-.001 lb	30390431	1441
5 lb-1/32 oz	30390432	1442
5 lb-.05 oz	30390430	1467
5 lb-1/32 oz	30390443	921
4 oz-1/32 oz	30390435	335
.2 lb-.001 lb	30390437	357

NVLAP Certificate		
Model	Item No.	Price USD
10 lb-1/32 oz	30390496	1517
10 lb-.001 lb	30390495	1542
5 lb-.001 lb	30390485	1726
5 lb-.001 lb	30390487	1709
5 lb-1/32 oz	30390488	1693
5 lb-.05 oz	30390486	1726
5 lb-1/32 oz	30390499	1109
4 oz-1/32 oz	30390491	570
.2 lb-.001 lb	30390493	455



SF40A

OHAUS Value in a Full-Featured, Portable Printer

- The statistics and totalization modes and real time clock complement OHAUS weighing instruments' application modes and offer functionality that assists the reporting processes.
- SF40A helps support the efficiency of the weighing and recording processes. RS232 interface and PC configuration software make setting up and using the printer fast and simple.
- With the ability to print in 13 different languages, SF40A can print in the language of the connected device to support universal operation.

Application	Impact Printing, Statistics, Totalization
Display	Not Applicable
Operation	AC adapter (included)
Communication	RS232 (included)
Construction	ABS Housing
Design Features	Status indicator, 40 characters per line, compatible with continuous label paper, perform zero and tare operations directly from the printer



Model	Item No.	Price USD
SF40A	30064203	798



STP103

Economical Palm-Sized Thermal Printer

- This ultra compact printer has a very small footprint and also features very low power consumption, requiring limited resources from your workspace.
- The extremely fast STP103 offers 42 column printing at a speed of approximately 11.8 lines per second.
- Loading paper into the printer is quick and easy and when the paper becomes low, the printer will suspend printing in order to prevent printing errors resulting from lack of paper.

Application	Thermal Printing
Display	Not Applicable
Operation	AC Adapter (Included)
Communication	RS232 (included)
Construction	ABS Housing
Design Features	Status indicator, paper feeder, graphical printing capabilities

Model	Item No.	Price USD
Printer, Thermal, STP103, 120vac US	80251992	622



Adapters

Accessories	Item No.	Price USD
Cable Kit, Loadcell Adapter, T51 T71	80500736	56

Anti-Theft Devices

Accessories	Item No.	Price USD
Anti-Theft Device, SP PA AV NV	80850000	72
Anti-Theft Device, MB AX EX	80850043	185

Auxiliary Displays

Accessories	Item No.	Price USD
Auxiliary Display, TAD7, SP SPJ TA TAJ	80251395	54
Auxiliary Display, PAD7, PA AX EX	80251396	54
Auxiliary Display, AVD7, AV PAJ	80251397	121

Base Mounts

Accessories	Item No.	Price USD
Base Mount Kit, Painted, T51P T71P	80500722	45
Handle Kit, D3K	30381321	80

Carrying Cases

Accessories	Item No.	Price USD
Carrying Case, CS	80010624	51
Carrying Case, V31	80251216	103
Carrying Case, FD V51	80251394	103
Carrying Case, EB EC	80251532	167
Carrying Case, SP	80850028	103
Carrying Case, Ranger	80850083	304
Carrying Case, TR TC R31 TC31 V71	80850084	304
Carrying Case, NVT	83032224	94
Carrying Case, NVL	83032225	94
Carrying Case, NV	83032226	94
Portable Bag STARTER	30031635	50

Column Mounts

Accessories	Item No.	Price USD
Column Kit, Painted, Floor Stand	30047153	86
Column Kit, SST, Floor Stand	30047154	204
Column Kit, EX-HiCap	30078082	122
Column Kit, Painted, R71	30095408	122
Column Kit, 230mm, SST, CKW	71167972	201
Wall Mount, Bracket	72197817	20
Column Adapter, Painted, T31P T51P T71P	72209339	21
Column Adapter, SST, T32XW T51XW T71XW	72209340	42
Column Kit, 680mm, SST, CKW	80251059	224
Column Kit, 350mm, Painted, T31P	80251743	71
Column Kit, 700mm, Painted, T31P	80251744	79
Column Kit, 350mm, SST, T32XW	80251745	161
Column Kit, 700mm, SST, T32XW	80251746	201
Column Kit, 350mm, Painted, T51P T71P	80500723	61
Column Kit, 680mm, Painted, T51P T71P	80500724	71
Column Kit, 350mm, SST, T51XW T71XW	80500725	138
Column Kit, 680mm, SST, T51XW T71XW	80500726	176
Column Kit, EX	83021102	133

Density Determination Kits

Accessories	Item No.	Price USD
Density Kit, SP SPJ	71147378	16
Density Kit, Solids	80253384	624

Dust Covers

Accessories	Item No.	Price USD
Dust Cover, Balance with Draft Shield	30093334	39
Stacking Kit, x6, STX SPX SKX SJX/E	30268987	51
Stacking Kit, x1, STX SPX SKX SJX/E	30268988	17
Dust Cover, Dial-O-Gram Cent-O-Gram	80780005	32
Dust Cover, Triple Beam	80780017	32
Dust Cover, Storage, Harvard	80850262	32

Interface Cables and Kits

Accessories	Item No.	Price USD
Ethernet Kit, R31 RC31 R71 V71	30037447	122
RS232 Kit, R31 RC31 R71 V71	30037448	122
USB Kit, R31 RC31 V71	30037449	122
Cable, RS422, 9m, EX EX-HiCap	30078078	122
Cable, Extension, 9m, R71	30101495	86
Ethernet Kit, T72XW	30132163	122
USB with I/O Kit, T72XW	30132164	136
COM2 Kit, T72XW	30132165	122
USB Extension Cable, EX	30217067	83
RS232 Interface, STX SPX ST3100M	30268982	133
USB Host Interface, STX SPX	30268983	133
USB Device Interface, STX SPX ST3100M	30268984	92
Bluetooth Interface, STX SPX	30268985	252
Ethernet Interface, STX SPX	30268986	144
RS422/485 Kit, T51 T71	80500731	79
RS232 Kit, T51 T71	80500733	59
RS232 Kit, 2nd, AV	80850092	155
RS232 Kit, 2nd, EX EX-HiCap	83021081	155
Ethernet Kit, EX EX-HiCap	83021082	155
Cable, USB, Type A-B	83021085	155
RS232 Kit, SP TA Navigator	83032107	133
USB Kit, SP TA NV NVL NVT	83032108	133
Ethernet Kit, NV NVL NVT	83032109	133
USB Kit, AV	83033014	155
Interface Kit, RS232-USB	30304101	116
Interface Kit, RS232-Ethernet	30304102	116

Pans, Stands, Bowls

Accessories	Item No.	Price USD
Pan, SST, R21 RC21 R31 RC31 V71	30037452	47
Platform, SST, 300x225mm, V22 V41	30251753	46
Pan Cover, SST, CL	80010623	14
Pan, SST, Flat, FD V51	80251141	48
Pan, SST, Sandwich, V31	80251147	66
Holder, SST, French Fries, V31	80251148	66
Holder, SST, Ice Cream Cone, V31	80251149	66
Pan, SST, C11P	80251248	42
Bowl, 1050ml, CS	80850075	42
Pan Cover, SST, CS	80850076	47

In-Use Covers

Accessories	Item No.	Price USD
In-Use-Cover, DV	12103498	66
In-Use-Cover, Large Housing, AV	12103879	31
In-Use-Cover, Small Housing, AV	12103980	31
In-Use-Cover, AR	12104951	42
In-Use-Cover, Small, RC RD RP	21203719	66
In-Use-Cover, Large, RC RD RP	21203720	78
In-Use-Cover, V71	30037445	30
In-Use-Cover, R21 RC21 R31 RC31	30037451	30
In-Use-Cover, Set(10), V71	30037469	61
In-Use-Cover, STARTER	30058734	19
In-Use-Cover wo DS AX	30111777	23
In-Use-Cover DS AX	30111792	23
Accessory, In Use Cover, R71	30135320	35
In-Use-Cover, Scout	30269022	17
In-Use-Cover, Set(3), SP	71168909	44
In-Use-Cover, bRite A51 A71	72247038	30
In-Use-Cover, Pan, bRite A51 A71	72247039	20
Cover In-Use R11P RC11P	80120028	42
In-Use-Cover, FD V51	80251140	32
In-Use-Cover, MB23 MB27	80252475	31
In-Use-Cover, EP VP	80850042	66
In-Use-Cover, MB35 MB45	80850085	63
In-Use-Cover, PA	83020221	37
In-Use-Cover, NVT	83032221	26
In-Use-Cover, NVL	83032222	26
In-Use-Cover, NV	83032223	26
In-Use-Cover, Terminal, EX	83033633	66
In-Use-Cover, ST5000	30129897	22

Relay Kits

Accessories	Item No.	Price USD
Relay Kit, AC, CKW	71167967	392
Relay Kit, DC, CKW	71173377	392
Relay Kit, AC, T51 T71	80500720	282
Relay Kit, DC, T51 T71	80500727	242

Rechargeable Batteries

Accessories	Item No.	Price USD
Rechargeable Battery, EX-HiCap R71	30041295	311
Rechargeable Battery Kit, CKW	71167966	371
Rechargeable Battery Kit, T51 T71	80500729	182
Rechargeable Battery, NVL NVT	83032106	45

Weighing & Measuring Accessories

Miscellaneous

Accessories	Item No.	Price USD
Scoop, Gold	30020842	23
PCBA Kit, 2nd Platform, RC31	30037446	122
Hook, R21 RC21 R31 RC31 V71	30037450	87
Wheel Kit, Set(4), EX-HiCap	30041470	133
Holder, Attached, Electrode	30058732	37
Holder, Stand Alone, Electrode	30058733	73
PCBA Kit, 2nd Platform, R71	30097590	123
Discrete I/O Kit, 2-In/4-Out, R71	30097591	122
Static Ionizer, ION-100A, AM	30130302	1403
Pipette Adjustment Kit, EX Semi-Micro	30252145	1168
Thermal Printer Head Assy bRite A71 AM	72253293	622
Subject Box	80000053	83
PCBA Kit, Alibi Memory, R71 T71	80500503	97
Kit, Rod and Clamp	80780011	60
Test Tube, 310-00 311-00	80780018	32
Weight Set, 2 x 1 kg, 1 x 500 g	80780108	61
Clamp, Gas Cylinder	80850312	79
Cable, RS422, Extension, EX EX-HiCap	83021083	86
Draft Shield Kit, EX	83021084	754
Foot Switch Kit, EX EX-HiCap	83021086	147
Seal kit, STARTER portables	83032962	38
Wheel Kit, Defenders	30372146	105

Moisture Analyzer Accessories

Accessories	Item No.	Price USD
Temp. Calibration Kit, MB Series	11113857	477
Holder, Pan, MB35 MB45	11113873	116
Scoop, Accessory, MB90 MB120	30284477	39
In-Use-Cover, Accessory, MB90 MB120	30284478	63
Holder, Pan, MB Series	80252476	63
Cage, Sample, MB Series	80252477	82
Pan, Reusable, Set(3), 7 mm, MB Series	80252478	68
Pan, Reusable, Set(3), 14 mm, MB Series	80252479	72
Pan, Aluminum, Set(100), MB200	80780012	66
Pan, Aluminum, Set(80), MB Series	80850086	51
Filter, Glass Fiber, Set(200)	80850087	83
Pan, Reusable(3), D90mm, MB45	80850088	166

Ramps

Accessories	Item No.	Price USD
Foot Plate, Set(2), Painted, VE VN	72198344	46
Ramp, 48 in x 26.4 in long, Painted, VN	80252565	630
Ramp, 60 in x 26.4 in long, Painted, VN	80252566	718
Ramp, 60 in x 48 in, 2.5 K/5 K, VX	80252766	832
Ramp, 60 in x 48 in, 5 K, VX	80252767	1050
Ramp, 60 in x 48 in, 10 K, VX	80252795	1716
Ramp, 60 in x 48 in, 10 K, VX	80252796	1899

Printer Cables

Accessories	Item No.	Price USD
Cable, PC, 9 Pin, NV AV	12106964	160
Cable, RS9 M/F, 1.5 m	12122603	155
Adapter, 9 Pin-9 Pin, PC-SF40A	30059316	29
Cable, RJ45-RS232, Printer, bRite A71	72249531	38
Adapter, 25 Pin-9 Pin, STP103	80251930	29
Adapter, 25 Pin -9 Pin, CBM910-SPU TA	80251934	29
Cable, RS232, CBM910-AV DV EX MB PA TxxP	80252571	155
Cable, RS232, CBM910-TC TR	80252573	155
Cable, RS232, CBM910-CKW TxxXW	80252574	172
Cable, ST103-AR EP VP	80252580	155
Cable, ST103-AV DV EX MB PA TxxP	80252581	155
Cable, ST103-TC TR	80252583	155
Cable, ST103-CKW55 TxxXW	80252584	172
Cable, 25 Pin, PC-Indicator	80500431	147
Cable, PC, 9 Pin, TR TC CD	80500433	147
Cable, 25 Pin-9 Pin, PC-TxxP	80500524	155
Cable, RS232, IBM 9P, AV DV MB Ranger	80500525	155
Cable, RS232 Connector, Ranger	80500526	155
Cable, RS232, CKW TxxXW	80500552	142
Cable, RS232, Ranger	80500556	155
Cable, CBM910-EP VP AR	80500570	155
Cable, SF42-AV DV MB Ranger	80500571	155
Adapter, 25 Pin-9 Pin, SF42 SRP275	80500572	54

Scoops

Accessories	Item No.	Price USD
Scoop, 110 x 90 x 30 mm, Black	80250048	29
Scoop, Flat Bottomed, SST, 0.6 l	80250400	59
Scoop, Large, Flat Bottomed, SST	80250954	74
Scoop and Counter Weight	80780001	49
Scoop, PP, 0.8 l	80780006	32
Scoop and Counter Weight, Poly	80780014	44
Scoop and Counter Weight, SST	80780015	103
Scoop and Counter Weight, 1.75 l	80780016	47
Scoop, Small, Analytical	80850321	31
Scoop, Large, PAJ	80850322	32
Scoop, Poly, 0.6l	80850359	33
Scoop, Small, PAJ	80850364	23

Software

Accessories	Item No.	Price USD
Software, Winwedge	80850080	437

Printer Supplies

Accessories	Item No.	Price USD
Paper Roll, Set(5), SF42	12101511	63
Ink Ribbon, SF40A SF42A	12120798	44
Paper Roll, Set (2), 57.5mm, SF40A	12120799	14
Axis, Paper Roll, SF40A	30063920	14
Paper Roll, (1), Thermal, STP103	80251931	16
Paper Roll, (1), CBM910	80251932	15
Ink Ribbon, CBM910	80251933	44

Wall Mounts

Accessories	Item No.	Price USD
Wall Mount Kit, SST, CKW	71167964	194
Wall Mount Kit, Painted, T51P T71P	72200227	47
Wall Mount Kit, Painted, T31P	80251747	34
Wall Mount Kit, SST, T32XW	80251748	42
Wall Mount Kit, SST, T51XW T71XW	80500735	65

Weight Accessories

Accessories	Item No.	Price USD
Weight Set, Metric, 1119-D0	80780008	212
Forceps, 70 mm, 2-3/8 in.	80780009	19
Forceps, 3-3/8	80780010	19

Laboratory Equipment



OHAUS is now offering equipment designed for every area of the laboratory, giving you the opportunity to Do More. From stirrers to shakers, lifts to clamps, our newly expanded portfolio is filled with products perfect for life sciences laboratories, giving you countless opportunities to fill every inch of your laboratory.



Frontier™ 5000 Series Micro

Smooth and Dependable High-Speed Microliter Centrifuge for Life Science Separation Applications

- The intuitive control panel with rotary knob puts the ability to quickly set and recall speed and g-force, as well as control the temperature (R model only) at your fingertips.
- A powerful brushless induction motor, 10 acceleration and deceleration ratings, and memory for up to 99 commonly-used parameters are a few of Frontier 5515(R)'s features that propel high-performance.
- Frontier 5515(R) has a lid locking system and sensor that stops the centrifuge if the rotors become imbalanced, protecting the operator from being injured by the spinning rotors.



- Application** Centrifugation
- Display** LCD, Backlight, 2 lines
- Operation** AC Power (Included)
- Construction** Brushless quiet motor, small footprint
- Design Features** High sample throughput, multi-safety control, personal program function

Model	Speed Range	Temp Range	Max g-force	Capacity	Dimensions (L x W x H)	Item No.	Price USD
FC5515	200 rpm-15,200 rpm	Air Cooled	21,953 g	12 x 5 ml; 4 x 8 place PCR Strips	15.43 x 11.3 x 11.5" (392 x 287 x 292 mm)	30130867	2652
FC5515R		-20° to 40°C			21.85 x 11.3 x 11.5" (555 x 287 x 292 mm)	30130869	5911

Accessories	Item No.	Price USD
Rotor, Angle, 24 x 1.5/2.0 ml	30130870	665
Rotor, Angle, 24 x 1.5/2.0 ml, Sealable	30130871	889
Rotor, Angle, 30 x 1.5/2.0 ml, Sealable	30130872	1193
Rotor, Angle, 12 x 5 ml, Sealable	30130873	1331

Accessories	Item No.	Price USD
Rotor, Angle, 4 x 8-Place PCR Stripes	30130874	1562
Rotor, Angle, 44 x 1.5/2.0 ml	30130879	952
Rotor, Hematocrit, 24x Capillaries	30130881	573

Frontier™ 5000 Series Multi Pro

Powerful and Versatile Universal Centrifuges for Virtually Every Lab Application

- Our multi-purpose centrifuges offer a high-speed centrifugation platform which can be customized to fit workflow needs using a wide variety of rotors and accessories.
- The intuitive design of the centrifuges & accessories enable easy access to parameter settings, and quick rotation between applications.
- The performance of these centrifuges is propelled by German engineering, and high-quality components for reliable use.

Application Centrifugal Separation, General Sample Preparation, Cell Pelleting, Protein Separation, Nucleic Acid Separation, Cell Concentrating, Chemical Separation, Diagnostics, Environmental Sample Preparation, Blood Sample Processing

Display Backlit Liquid Crystal Display (LCD)

Operation Designed to be used with a variety of rotors and accessories

Construction Corrosion-resistant stainless steel chamber with Polycarbonate/ABS plastic lid

Design Features Ten acceleration & deceleration rates, selection of running time from 10 s to 99 h 59 min or continuous, quick spin, CFC-free refrigeration system, sample temp. indication (refrigerated models), lid-locking system, over-speed protection, dual imbalance sensing



Model	Speed Range	Temp Range	Max g-force	Capacity	Dimensions (L x W x H)	Item No.	Price USD
FC5714	200 rpm–14,000 rpm	Air Cooled	18,624 g	4 × 100 ml	19.4 x 14.25 x 14.25" (14.25 x 362 x 362 mm)	30314811	2925
FC5718	200 rpm–18,000 rpm	Air Cooled	23,542 g		19.65 x 16.06 x 13.82" (499 x 408 x 351 mm)	30314813	4225
FC5718R		-20° to 40°C			28.78 x 16.02 x 14.13" (731 x 407 x 359 mm)	30314815	6316
FC5816	200 rpm–15,000 rpm	Air Cooled	21,379 g	6 × 250 ml	21.18 x 21.18 x 13.94" (538 x 446 x 354 mm)	30314817	5045
FC5816R	200 rpm–16,000 rpm	-20° to 40°C	24,325 g		21.18 x 28.46 x 28.46" (28.46 x 723 x 354 mm)	30314819	7895

Accessories	Item No.	Price USD
Rotor, Angle, 24 × 1.5/2.0 ml, ID, Sealable	30304361	978
Rotor, Swing out, 4 × 250 ml, ID	30314820	1363
Rotor, Angle, 6 × 250 ml FB, ID	30314821	3361
Rotor, Swing out, 4 × 100 ml, ID	30314822	1128
Rotor, Swing out, 4 × 100 ml, ID, Sealable	30314823	948
Rotor, Swing out, 2 × 3MTP, ID	30314824	1646
Rotor, Angle, 6 × 85 ml RB, ID, Hi	30314825	1875
Rotor, Angle, 6 × 85 ml RB, ID	30314826	1899
Rotor, Angle, 4 × 85 ml RB, ID, Hi	30314827	1936
Rotor, Swing out, 16 × 50 ml, ID	30314828	2019
Rotor, Angle, 10 × 50 ml FA, ID	30314829	2407

Accessories	Item No.	Price USD
Rotor, Angle, 6 × 50 ml RB/FA, ID	30314830	818
Rotor, Angle, 6 × 50 ml RB, ID, Hi	30314831	1645
Rotor, Angle, 30 × 15 ml RB/FA, ID	30314832	1280
Rotor, Angle, 20 × 10 ml RB, ID, Hi	30314833	1693
Rotor, Angle, 12 × 15 ml RB/FA, ID	30314834	829
Rotor, Angle, 44 × 1.5/2.0 ml, ID	30314835	1041
Rotor, Angle, 30 × 1.5/2.0 ml, ID, Sealable	30314836	1324
Rotor, Angle, 24 × 1.5/2.0 ml, ID	30314838	738
Rotor, Angle, 12 × 1.5/2.0 ml, ID	30314839	1185
Rotor, Angle, 64 × 0.5 ml, ID	30314840	1202
Rotor, Angle, 4 × 8-w PCR Strip, ID	30314841	1716

Frontier™ 5000 Series Multi

Reliable and Compact Multi-Function Centrifuge For Standard Life Science Separation Applications

- With an easy-to-turn control knob, a large LCD display and capabilities to set and view speed in both rpm and g-force, enjoy precise results and enhanced functionality with extremely simple operation.
- Frontier 5706 can accommodate standard tube sizes from 1.5 mL to 50 mL and can hold six 50 mL tubes and twelve 15 mL tubes during one process, providing centrifugation for a wide variety of applications.
- Frontier 5706 has a lid locking system and sensor that stops the centrifuge if the rotors become imbalanced, protecting the operator from being injured by the spinning rotors.



- Application** Centrifugation
- Display** LCD, Backlight, 2 lines
- Operation** AC Power (Included)
- Construction** Brushless quiet motor, small footprint
- Design Features** Easy installation design

Model	Maximum Speed	Max g-force	Capacity	Dimensions (L x W x H)	Item No.	Price USD
FC5706 120V	200 rpm–6,000 rpm	4,427 g	6 × 50 ml	15.4 x 11.5 x 10.5" (392 x 291 x 266 mm)	30130876	2183

Accessories	Item No.	Price USD
Rotor, Angle, 12 x 15mL, round/conical bottom	30130877	506
Rotor, Angle, 6 x 50mL, round/conical bottom	30130878	898
Rotor, Swing Out, 6 × 5 ml RB	30130880	602

Frontier™ 5000 Series Mini

Powerful and Convenient Mini Centrifuge for Simple and Quick Life Science Separation Applications

- With a low voltage power input, quiet brushless motor and a rubber base that absorbs vibrations, Frontier 5306 minimizes operational noise and reduces disruptions in the laboratory.
- Frontier 5306 is designed with operator safety in mind, and includes a rotor imbalance sensor and two safety switches which immediately stop the rotors should the lid open during use.
- Frontier 5306 takes simple one-step operation to a new level. Simply place your sample in the centrifuge, close the lid, and it will begin to rotate without the press of a button for reliable use.



Two rotors and adapters are included

Application	Sample preparation
Operation	AC adapter (included)
Construction	Brushless quiet motor, auto shut-off safety switches
Design Features	One-touch operation

Model	Maximum Speed	Max g-force	Capacity	Dimensions (L x W x H)	Item No.	Price USD
FC5306	6,000 rpm	2,000 g	8 × 1.5 ml / 2.0 ml; 4 × 8 place PCR Strips	6.6 x 5.9 x 5" (168 x 150 x 128 mm)	30134157	298

Accessories	Item No.	Price USD
Adapter for 0.2 ml Tube (8PCS/Package)	30129561	44
Adapter for 0.5 ml Tube (8PCS/Package)	30129562	44

Frontier™ 5000 Rotors

Offering Flexibility to Maximize Sample Preparation

- Choose from a range of rotors to be used with Frontier centrifuges to match capacities and flexibility required for your basic to high-performance sample preparation needs.
- Designed with usability in mind, the Frontier rotors can be effortlessly installed or removed in a few quick and simple steps, and users have easy access to the samples.
- The sturdy rotors are constructed of high-quality materials, built to last through demanding workflows from autoclave sterilization to sub-zero temperature.



Application Centrifugation Accessory

Construction Aluminum or polypropylene material

Model	Rotor Style	Capacity	Max g-force	Maximum Speed	Item No.	Price USD
R-A8 × 2/6M	Angle	8 × 1.5 / 2.0 ml	2,560 g	6,000 rpm	30129559	44
R-A4 × PCR/6		4 × 0.2 ml PCR8	2,260 g		30129560	44
R-A24 × 2/15M		24 × 1.5 / 2.0 ml	21,953 g	15,200 rpm	30130870	665
R-A24 × 2/15MS					30130871	889
R-A30 × 2/13MS		30 × 1.5 / 2.0 ml	19,150 g	13,500 rpm	30130872	1193
R-A12 × 5/14MS		12 × 5 ml	19,978 g	14,500 rpm	30130873	1331
R-A4 × PCR/15		4 × 0.2 ml PCR8	15,342 g	15,000 rpm	30130874	1562
R-A12 × 15/6M		12 × 15 ml	4,427 g	6,000 rpm	30130877	506
R-A6 × 50/6M		6 × 50 ml			30130878	898
R-A44 × 2/13M		44 × 1.5 / 2.0 ml	17,317 g	13,500 rpm	30130879	952
R-S6 × 5/4		Swing out	6 × 5 ml	1,817 g	4,000 rpm	30130880
R-A24 × CAP/12	Angle	24 × Capillaries	14,970 g	12,000 rpm	30130881	573
R-A24 × 2/16MIS		24 × 1.5 / 2.0 ml	24,325 g	16,000 rpm	30304361	978
R-S4 × 250/4MI	Swing out	4 × 250 ml	3,780 g	4,500 rpm	30314820	1363
R-A6 × 250/8MI	Angle	6 × 250 ml	10,016 g	8,000 rpm	30314821	3361
R-S4 × 100/4MI	Swing out	4 × 100 ml	3,350 g	4,500 rpm	30314822	1128
R-S4 × 100/5MIS			3,885 g	5,000 rpm	30314823	948
R-S6 × MTP/4MI		2 × 3 MTP	2,716 g	4,500 rpm	30314824	1646
R-A6 × 85/14MI	Angle	6 × 85 ml	20,984 g	13,500 rpm	30314825	1875
R-A6 × 85/13MI			21,726 g	13,000 rpm	30314826	1899
R-A4 × 85/12MI		4 × 85 ml	14,809 g	12,000 rpm	30314827	1936
R-S16 × 50/4MI	Swing out	16 × 50 ml	3,735 g	4,500 rpm	30314828	2019
R-A10 × 50/10MI	Angle	10 × 50 ml	16,022 g	10,500 rpm	30314829	2407
R-A6 × 50/6MI		6 × 50 ml	4,427 g	6,000 rpm	30314830	818
R-A6 × 50/13MI			15,869 g	13,000 rpm	30314831	1645
R-A30 × 15/4MI			30 × 15 ml	2,830 g	4,500 rpm	30314832
R-A20 × 10/12MI		20 × 10 ml	15,775 g	12,000 rpm	30314833	1693
R-A12 × 15/6MI		12 × 15 ml	4,427 g	6,000 rpm	30314834	829
R-A44 × 2/16MI		44 × 1.5 / 2.0 ml	24,039 g	16,000 rpm	30314835	1041
R-A30 × 2/14MIS		30 × 1.5 / 2.0 ml	20,595 g	14,000 rpm	30314836	1324
R-A24 × 2/16MI		24 × 1.5 / 2.0 ml	24,325 g	16,000 rpm	30314838	738
R-A12 × 2/18MI		12 × 1.5 / 2.0 ml	23,542 g	18,000 rpm	30314839	1185
R-A64 × 0.5/13I		64 × 0.5 ml	16,298 g	13,500 rpm	30314840	1202
R-A4 × PCR/15I		4 × 8-w PCR Strip	15,343 g	15,000 rpm	30314841	1716

Multi Pro Centrifuge Rotors & Accessories

Frontier rotors extend the functionality of Frontier centrifuges by increasing the number of tubes of varied types and sizes that can be used in conjunction with each of the centrifuge models. Easy to clean and operate, the rotors are durably constructed to withstand demanding centrifugation.

Fixed Angle Rotor 24x1.5/2.0ml

Description	Item No.	Price USD
Rotor, Angle, 24x1.5/2.0ml, ID, Sealable	30304361	978

Compatible to	FC5714	FC5718	FC5718R	FC5816	FC5816R
Max. Speed	14000 rpm	14000 rpm	15000 rpm	15000 rpm	16000 rpm
Max. RCF	18624 xg	18624 xg	21379 xg	21379 xg	24325 xg



Accessories	Vol./Tube	Diameter	Tube type	No.of tubes/rotor	Item No.	Price USD
Adapter, 1x0.5ml D8mm, 6/pk	0.5ml	8mm	Eppendorf tube	24	30130885	44
Adapter, 1x0.2/0.4ml D6mm, 6/pk	0.2/0.4ml	6mm	Eppendorf tube	24	30130884	44

Fixed Angle Rotor 6x250ml FB

Description	Item No.	Price USD
Rotor, Angle, 6x250ml FB, ID	30314821	3361

Compatible to	FC5714	FC5718	FC5718R	FC5816	FC5816R
Max. Speed	-	-	-	8000 rpm	8000 rpm
Max. RCF	-	-	-	10016 xg	10016 xg



Accessories	Vol./Tube	Diameter	Tube type	No.of tubes/rotor	Item No.	Price USD
Adapter, 1x50ml D30mm FA, 2/pk	50ml	30mm	Conical bottom	6	30304374	234
Adapter, 1x50ml D29mm RB, 2/pk	50ml	29mm	Round bottom	6	30304373	234
Adapter, 2x30ml D26mm RB, 2/pk	30ml	26mm	Round bottom	12	30304372	234
Adapter, 4x15ml D17mm FA, 2/pk	15ml	17mm	Conical bottom	24	30304371	234
Adapter, 5x10ml D16mm RB, 2/pk	10ml	16mm	Round bottom	30	30304370	234
Adapter, 8x1.5ml D11mm, 2/pk	1.5ml	11mm	Eppendorf tube	48	30304369	234

Multi Pro Centrifuge Rotors & Accessories

Fixed Angle Rotor 6x85ml RB

Description	Item No.	Price USD
Rotor, Angle, 6x85ml RB, ID, Hi	30314825	1875

Compatible to	FC5714	FC5718	FC5718R	FC5816	FC5816R
Max. Speed	-	11000 rpm	13500 rpm	-	-
Max. RCF	-	13932 xg	20984 xg	-	-



Accessories	Vol./Tube	Diameter	Tube type	No.of tubes/rotor	Item No.	Price USD
Adapter, 1x50ml D29mm RB, 2/pk, v2	50ml	29mm	Round bottom	6	30314895	165
Adapter, 1x50ml D29mm FA, 2/pk	50ml	29mm	Conical bottom	6	30314896	165
Adapter, 1x30ml D25mm RB, 2/pk	30ml	25mm	Round bottom	6	30314894	165
Adapter, 1x16ml D18mm RB, 2/pk	16ml	18mm	Round bottom	6	30314899	165
Adapter, 1x15ml D17mm FA, 2/pk	15ml	17mm	Conical bottom	6	30314897	165
Adapter, 2x15ml D17mm RB, 2/pk	15ml	17mm	Round bottom	12	30314898	165
Adapter, 1x15ml D17mm RB, 2/pk	15ml	17mm	Round bottom	6	30314893	165

Fixed Angle Rotor 6x85ml RB

Description	Item No.	Price USD
Rotor, Angle, 6x85ml RB, ID	30314826	1899

Compatible to	FC5714	FC5718	FC5718R	FC5816	FC5816R
Max. Speed	-	9000 rpm	9000 rpm	11000 rpm	13000 rpm
Max. RCF	-	10413 xg	10413 xg	15555 xg	21726 xg



Accessories	Vol./Tube	Diameter	Tube type	No.of tubes/rotor	Item No.	Price USD
Adapter, 1x50ml D29mm RB, 2/pk, v2	50ml	29mm	Round bottom	6	30314895	165
Adapter, 1x50ml D29mm FA, 2/pk	50ml	29mm	Conical bottom	6	30314896	165
Adapter, 1x30ml D25mm RB, 2/pk	30ml	25mm	Round bottom	6	30314894	165
Adapter, 1x16ml D18mm RB, 2/pk	16ml	18mm	Round bottom	6	30314899	165
Adapter, 1x15ml D17mm FA, 2/pk	15ml	17mm	Conical bottom	6	30314897	165
Adapter, 2x15ml D17mm RB, 2/pk	15ml	17mm	Round bottom	12	30314898	165
Adapter, 1x15ml D17mm RB, 2/pk	15ml	17mm	Round bottom	6	30314893	165

Multi Pro Centrifuge Rotors & Accessories

Fixed Angle Rotor 4x85ml RB

Description	Item No.	Price USD
Rotor, Angle, 4x85ml RB, ID, Hi	30314827	1936

Compatible to	FC5714	FC5718	FC5718R	FC5816	FC5816R
Max. Speed	-	12000 rpm	12000 rpm	12000 rpm	12000 rpm
Max. RCF	-	14809 xg	14809 xg	14809 xg	14809 xg



Accessories	Vol./Tube	Diameter	Tube type	No.of tubes/rotor	Item No.	Price USD
Adapter, 1x50ml D29mm RB, 2/pk, v2	50ml	29mm	Round bottom	4	30314895	165
Adapter, 1x50ml D29mm FA, 2/pk	50ml	29mm	Conical bottom	4	30314896	165
Adapter, 1x30ml D25mm RB, 2/pk	30ml	25mm	Round bottom	4	30314894	165
Adapter, 1x16ml D18mm RB, 2/pk	16ml	18mm	Round bottom	4	30314899	165
Adapter, 1x15ml D17mm FA, 2/pk	15ml	17mm	Conical bottom	4	30314897	165
Adapter, 2x15ml D17mm RB, 2/pk	15ml	17mm	Round bottom	8	30314898	165
Adapter, 1x15ml D17mm RB, 2/pk	15ml	17mm	Round bottom	4	30314893	165

Fixed Angle Rotor 10x50ml FA

Description	Item No.	Price USD
Rotor, Angle, 10x50ml FA, ID	30314829	2407

Compatible to	FC5714	FC5718	FC5718R	FC5816	FC5816R
Max. Speed	-	7500 rpm	7500 rpm	9000 rpm	10500 rpm
Max. RCF	-	8174 xg	8174 xg	11771 xg	16022 xg



Accessories	Vol./Tube	Diameter	Tube type	No.of tubes/rotor	Item No.	Price USD
Adapter, 1x15ml D17mm RB, 2/pk, v2	15ml	17mm	Round bottom	10	30130894	151
Adapter, 1x7ml D13.5mm RB, 2/pk	7ml	13.5mm	Round bottom	10	30130889	104
Adapter, 1x5ml D13.5mm, 2/pk	5ml	13.5mm	Round bottom	10	30130890	94
Adapter, 1x1.5/2.0ml D11mm, 6/pk	1.5/2.0ml	11mm	Eppendorf tube	10	30130886	173

Multi Pro Centrifuge Rotors & Accessories

Fixed Angle Rotor 6x50ml RB/FA

Description	Item No.	Price USD
Rotor, Angle, 6x50ml RB/FA, ID	30314830	818



Compatible to	FC5714	FC5718	FC5718R	FC5816	FC5816R
Max. Speed	6000 rpm	6000 rpm	6000 rpm	-	-
Max. RCF	4427 xg	4427 xg	4427 xg	-	-

Accessories	Vol./Tube	Diameter	Tube type	No.of tubes/rotor	Item No.	Price USD
Adapter, 1x30ml D26mm, 2/pk	30ml	26mm	Round bottom	6	30130891	218
Adapter, 1x16ml D18mm, 2/pk	16ml	18mm	Round bottom	6	30130892	218
Adapter, 1x15ml D17mm, 2/pk	15ml	17mm	Round bottom	6	30130893	218
Adapter, 1x15ml D17mm RB, 2/pk, v2	15ml	17mm	Round/Conical bottom	6	30130894	151
Adapter, 1x7ml D13.5mm RB, 2/pk	7ml	13.5mm	Round bottom	6	30130889	104
Adapter, 1x5ml D13.5mm, 2/pk	5ml	13.5mm	Round bottom	6	30130890	94
Adapter, 1x1.5/2.0ml D11mm, 6/pk	1.5/2.0ml	11mm	Eppendorf tube	6	30130886	173

Fixed Angle Rotor 6x50ml RB

Description	Item No.	Price USD
Rotor, Angle, 6x50ml RB, ID, Hi	30314831	1645



Compatible to	FC5714	FC5718	FC5718R	FC5816	FC5816R
Max. Speed	-	12000 rpm	12000 rpm	13000 rpm	13000 rpm
Max. RCF	-	13522 xg	13522 xg	15869 xg	15869 xg

Accessories	Vol./Tube	Diameter	Tube type	No.of tubes/rotor	Item No.	Price USD
Adapter, 1x30ml D26mm, 2/pk	30ml	26mm	Round bottom	6	30130891	218
Adapter, 1x16ml D18mm, 2/pk	16ml	18mm	Round bottom	6	30130892	218
Adapter, 1x15ml D17.5mm FA, 2/pk	15ml	17.5mm	Conical bottom	6	30314892	185
Adapter, 1x15ml D17mm, 2/pk	15ml	17mm	Round bottom	6	30130893	218

Multi Pro Centrifuge Rotors & Accessories

Fixed Angle Rotor 30x15ml RB/FA

Description	Item No.	Price USD
Rotor, Angle, 30x15ml RB/FA, ID	30314832	1280



Compatible to	FC5714	FC5718	FC5718R	FC5816	FC5816R
Max. Speed	4500 rpm	4500 rpm	4500 rpm	4500 rpm	4500 rpm
Max. RCF	2830 xg	2830 xg	2830 xg	2830 xg	2830 xg

Accessories	Vol./Tube	Diameter	Tube type	No.of tubes/rotor	Item No.	Price USD
Adapter, 1x7ml D13.5mm RB, 2/pk	7ml	13.5mm	Round bottom	30	30130889	104
Adapter, 1x5ml D13.5mm, 2/pk	5ml	13.5mm	Round bottom	30	30130890	94
Adapter, 1x1.5/2.0ml D11mm, 6/pk	1.5/2.0ml	11mm	Eppendorf tube	30	30130886	173

Fixed Angle Rotor 20x10ml RB

Description	Item No.	Price USD
Rotor, Angle, 20x10ml RB, ID, Hi	30314833	1693



Compatible to	FC5714	FC5718	FC5718R	FC5816	FC5816R
Max. Speed	-	12000 rpm	12000 rpm	12000 rpm	12000 rpm
Max. RCF	-	15775 xg	15775 xg	15775 xg	15775 xg

Fixed Angle Rotor 12x15ml RB/FA

Description	Item No.	Price USD
Rotor, Angle, 12x15ml RB/FA, ID	30314834	829



Compatible to	FC5714	FC5718	FC5718R	FC5816	FC5816R
Max. Speed	6000 rpm	6000 rpm	6000 rpm	-	-
Max. RCF	4427 xg	4427 xg	4427 xg	-	-

Accessories	Vol./Tube	Diameter	Tube type	No.of tubes/rotor	Item No.	Price USD
Adapter, 1x7ml D13.5mm RB, 2/pk	7ml	13.5mm	Round bottom	12	30130889	104
Adapter, 1x5ml D13.5mm, 2/pk	5ml	13.5mm	Round bottom	12	30130890	94
Adapter, 1x1.5/2.0ml D11mm, 6/pk	1.5/2.0ml	11mm	Eppendorf tube	12	30130886	173

Multi Pro Centrifuge Rotors & Accessories

Fixed Angle Rotor 44x1.5/2.0ml

Description	Item No.	Price USD
Rotor, Angle, 44x1.5/2.0ml, ID	30314835	1041

Compatible to	FC5714	FC5718	FC5718R	FC5816	FC5816R
Max. Speed	-	13500 rpm	13500 rpm	15000 rpm	16000 rpm
Max. RCF	-	17113 xg	17113 xg	21128 xg	24039 xg



Accessories	Vol./Tube	Diameter	Tube type	No.of tubes/rotor	Item No.	Price USD
Adapter, 1x0.5ml D8mm, 6/pk	0.5ml	8mm	Eppendorf tube	44	30130885	88
Adapter, 1x0.2/0.4ml D6mm, 6/pk	0.2/0.4ml	6mm	Eppendorf tube	44	30130884	88

Fixed Angle Rotor 30x1.5/2.0ml

Description	Item No.	Price USD
Rotor, Angle, 30x1.5/2.0ml, ID, Sealable	30314836	1324

Compatible to	FC5714	FC5718	FC5718R	FC5816	FC5816R
Max. Speed	12000 rpm	13000 rpm	14000 rpm	-	-
Max. RCF	15131 xg	17758 xg	20595 xg	-	-



Accessories	Vol./Tube	Diameter	Tube type	No.of tubes/rotor	Item No.	Price USD
Adapter, 1x0.5ml D8mm, 6/pk	0.5ml	8mm	Eppendorf tube	30	30130885	88
Adapter, 1x0.2/0.4ml D6mm, 6/pk	0.2/0.4ml	6mm	Eppendorf tube	30	30130884	88

Fixed Angle Rotor 24x1.5/2.0ml

Description	Item No.	Price USD
Rotor, Angle, 24x1.5/2.0ml, ID	30314838	738

Compatible to	FC5714	FC5718	FC5718R	FC5816	FC5816R
Max. Speed	14000 rpm	14000 rpm	15000 rpm	15000 rpm	16000 rpm
Max. RCF	18624 xg	18624 xg	21379 xg	21379 xg	24325 xg



Accessories	Vol./Tube	Diameter	Tube type	No.of tubes/rotor	Item No.	Price USD
Adapter, 1x0.5ml D8mm, 6/pk	0.5ml	8mm	Eppendorf tube	24	30130885	88
Adapter, 1x0.2/0.4ml D6mm, 6/pk	0.2/0.4ml	6mm	Eppendorf tube	24	30130884	88

Multi Pro Centrifuge Rotors & Accessories

Fixed Angle Rotor 12x1.5/2.0ml

Description	Item No.	Price USD
Rotor, Angle, 12x1.5/2.0ml, ID	30314839	1185

Compatible to	FC5714	FC5718	FC5718R	FC5816	FC5816R
Max. Speed	-	18000 rpm	18000 rpm	-	-
Max. RCF	-	23542 xg	23542 xg	-	-



Accessories	Vol./Tube	Diameter	Tube type	No.of tubes/rotor	Item No.	Price USD
Adapter, 1x1.5ml for over16000xg, 6/pk	1.5ml	11mm	Eppendorf tube	12	30314900	89
Adapter, 1x0.5ml D8mm, 6/pk	0.5ml	8mm	Eppendorf tube	12	30130885	88
Adapter, 1x0.2/0.4ml D6mm, 6/pk	0.2/0.4ml	6mm	Eppendorf tube	12	30130884	88

Fixed Angle Rotor 64x0.5ml

Description	Item No.	Price USD
Rotor, Angle, 64x0.5ml, ID	30314840	1202

Compatible to	FC5714	FC5718	FC5718R	FC5816	FC5816R
Max. Speed	-	13500 rpm	13500 rpm	-	-
Max. RCF	-	16298 xg	16298 xg	-	-



Fixed Angle Rotor 4x8-w PCR Strip

Description	Item No.	Price USD
Rotor, Angle, 4x8-w PCR Strip, ID	30314841	1716

Compatible to	FC5714	FC5718	FC5718R	FC5816	FC5816R
Max. Speed	-	15000 rpm	15000 rpm	-	-
Max. RCF	-	15343 xg	15343 xg	-	-



Multi Pro Centrifuge Rotors & Accessories

Swing Out Rotors 4x250ml

Description	Item No.	Price USD
Rotor, Swing out, 4x250ml, ID	30314820	1363

Compatible to	FC5714	FC5718	FC5718R	FC5816	FC5816R
Max. Speed	-	-	-	4500 rpm	4500 rpm
Max. RCF	-	-	-	3780 xg	3780 xg



Accessories	Vol./Tube	Diameter	Tube type	No.of tubes/rotor	Item No.	Price USD
Screw Cap, Rack of 250ml Rotor, 2/pk	-	-	-	-	30314901	112
O-ring, Rack of 250ml Rotor, 10/pk	-	-	-	-	30314902	57
Rack, 1x250ml D62mm FB, 2/pk	250ml	62mm	Flat bottom	4	30314903	272
Rack, 1x100ml D41mm RB, 2/pk	100ml	41mm	Round bottom	4	30314904	272
Rack, 1x50ml D34mm RB, 2/pk, v3	50ml	34mm	Round bottom	4	30314907	272
Rack, 3x50ml D29mm RB, 2/pk	50ml	29mm	Round bottom	12	30314905	272
Rack, 3x50ml D29mm FA, 2/pk	50ml	29mm	Conical bottom	12	30314906	272
Rack, 2x50ml D29mm Rim, 2/pk	50ml	29mm	Skirted conical bottom	8	30314908	272
Rack, 1x50ml D29mm Rim, 2/pk, v3	50ml	29mm	Skirted conical bottom	4	30314909	272
Rack, 5x25ml D24.5mm RB, 2/pk	25ml	24.5mm	Round bottom	20	30314910	272
Rack, 3x25ml D24.5mm Rim, 2/pk	25ml	24.5mm	Skirted conical bottom	12	30314911	272
Rack, 9x15ml D17mm RB, 2/pk	15ml	17mm	Round bottom	36	30314912	272
Rack, 7x15ml D17mm FA, 2/pk	15ml	17mm	Conical bottom	28	30314913	272
Rack, 7x15ml D17mm Rim, 2/pk	15ml	17mm	Skirted conical bottom	28	30314914	272
Rack, 8x10ml D16mm RB, 2/pk	10ml	16mm	Round bottom	32	30314915	272
Rack, 8x4-10ml D16mm Vac, 2/pk	4-10ml	16mm	Vacutainer	32	30304367	272
Rack, 14x5-7ml D13mm RB, 2/pk	5-7ml	13mm	Round bottom	56	30314916	272
Rack, 10x1.6-7ml D13mm Vac, 2/pk	1.6-7ml	13mm	Vacutainer	40	30314917	272
Adapter, 9x1.5/2.0ml D11mm, 2/pk	1.5/2.0ml	11mm	Eppendorf tube	36	30304368	251

Multi Pro Centrifuge Rotors & Accessories

Swing Out Rotor 4x100ml

Description	Item No.	Price USD
Rotor, Swing out, 4x100ml, ID	30314822	1128

Compatible to	FC5714	FC5718	FC5718R	FC5816	FC5816R
Max. Speed	4500 rpm	4500 rpm	4500 rpm	-	-
Max. RCF	3350 xg	3350 xg	3350 xg	-	-



Accessories	Vol./Tube	Diameter	Tube type	No.of tubes/rotor	Item No.	Price USD
Rack, 1x100ml D46mm RB, 2/pk	100ml	46mm	Round bottom	4	30314842	236
Rack, 1x85ml D38mm RB, 2/pk	85ml	38mm	Round bottom	4	30314843	236
Rack, 1x50ml D34mm RB, 2/pk	50ml	34mm	Round bottom	4	30314844	236
Rack, 1x50ml D29mm RB, 2/pk	50ml	29mm	Round bottom	4	30314845	236
Rack, 1x50ml D29mm FA, 2/pk	50ml	29mm	Conical bottom	4	30314846	236
Rack, 1x50ml D29mm Rim, 2/pk	50ml	29mm	Skirted conical bottom	4	30314847	236
Rack, 1x30ml D25mm Rim, 2/pk	30ml	25mm	Skirted conical bottom	4	30314848	236
Rack, 1x25ml D25mm RB, 2/pk	25ml	25mm	Round bottom	4	30314849	236
Rack, 7x15ml D17mm RB, 2/pk	15ml	17mm	Round bottom	28	30314852	236
Rack, 2x15ml D17mm FA, 2/pk	15ml	17mm	Conical bottom	8	30314850	236
Rack, 1x15ml D17mm Rim, 2/pk	15ml	17mm	Skirted conical bottom	4	30314851	236
Rack, 5x4-10ml D16mm Sar, 2/pk	4-10ml	16mm	Sarstedt	20	30314858	236
Rack, 9x5-7ml D13mm RB, 2/pk	5-7ml	13mm	Round bottom	36	30314853	236
Rack, 7x5-7ml D13mm RB, 2/pk	5-7ml	13mm	Round bottom	28	30314856	236
Rack, 7x5-7ml D13mm Vac, 2/pk	5-7ml	13mm	Vacutainer	28	30314857	236
Rack, 10x1.5ml D11mm, 2/pk	1.5ml	11mm	Eppendorf tube	40	30314854	236
Rack, 9x4.5ml D12mm FB, 2/pk	4.5ml	12mm	Flat bottom	36	30314855	236

Multi Pro Centrifuge Rotors & Accessories

Swing Out Rotors 4x100ml

Description	Item No.	Price USD
Rotor, Swing out, 4x100ml, ID, Sealable	30314823	948



Compatible to	FC5714	FC5718	FC5718R	FC5816	FC5816R
Max. Speed	4000 rpm	5000 rpm	5000 rpm	-	-
Max. RCF	2486 xg	3885 xg	3885 xg	-	-

Accessories	Vol./Tube	Diameter	Tube type	No.of tubes/rotor	Item No.	Price USD
Bucket, 100ml w/o Cap, 2/pk	-	-	-	-	30314860	282
Bucket, 100ml w/ Cap, Sealable, 2/pk	-	-	-	-	30314861	339
Screw Cap, 100ml Bucket, Sealable, 2/pk	-	-	-	-	30314862	98
O-ring, 100ml Bucket, Sealable, 10/pk	-	-	-	-	30314863	47
Rack, 1x100ml D40mm RB, 2/pk	100ml	40mm	Round bottom	4	30314864	212
Rack, 1x85ml D38mm RB, 2/pk, v2	85ml	38mm	Round bottom	4	30314865	212
Rack, 1x50ml D34mm RB, 2/pk, v2	50ml	34mm	Round bottom	4	30314866	212
Rack, 1x50ml D29mm RB, 2/pk, v2	50ml	29mm	Round bottom	4	30314867	212
Rack, 1x50ml D29mm FA, 2/pk, v2	50ml	29mm	Conical bottom	4	30314868	212
Bucket, 2x50ml D29mm FA, w/ Rack, 2/pk	50ml	29mm	Conical bottom	8	30314881	451
Rack, 1x50ml D29mm Rim, 2/pk, v2	50ml	29mm	Skirted conical bottom	4	30314869	212
Rack, 1x30ml D25mm Rim, 2/pk, v2	30ml	25mm	Skirted conical bottom	4	30314870	212
Rack, 1x25ml D25mm RB, 2/pk, v2	25ml	25mm	Round bottom	4	30314871	212
Rack, 1x15ml D17mm FA, 2/pk	15ml	17mm	Conical bottom	4	30314872	212
Rack, 2x15ml D17mm FA, 2/pk, v2	15ml	17mm	Conical bottom	8	30314873	212
Rack, 2x15ml D17mm Rim, 2/pk	15ml	17mm	Skirted conical bottom	8	30314874	212
Rack, 4x15ml D17mm RB, 2/pk	15ml	17mm	Round bottom	16	30314875	212
Bucket, 3x15ml D17mm FA, w/ Rack, 2/pk	15ml	17mm	Conical bottom	12	30314882	453
Rack, 3x10ml D17mm Sar, 2/pk	10ml	17mm	Sarstedt	12	30314878	212
Rack, 4x10ml D17mm Vac, 2/pk	10ml	17mm	Vacutainer	16	30314880	212
Rack, 7x5-7ml D13mm RB, 2/pk, v2	5-7ml	13mm	Round bottom	28	30314876	212
Rack, 4x5-7ml D13mm RB, 2/pk	5-7ml	13mm	Round bottom	16	30314879	212
Rack, 5x1.5ml D11mm, 2/pk	1.5ml	11mm	Eppendorf tube	20	30314877	212

Multi Pro Centrifuge Rotors & Accessories

Swing Out Rotors 2x3MTP

Description	Item No.	Price USD
Rotor, Swing out, 2x3MTP, ID	30314824	1646

Compatible to	FC5714	FC5718	FC5718R	FC5816	FC5816R
Max. Speed	4500 rpm	4500 rpm	4500 rpm	4500 rpm	4500 rpm
Max. RCF	2716 xg	2716 xg	2716 xg	2716 xg	2716 xg



Accessories	Vol./Tube	Diameter	Tube type	No.of tubes/rotor	Item No.	Price USD
Bucket, 3xMTP, 2/pk	MTP	-	-	6	30314890	2781
Adapter, 48x1.5/2.0ml D11mm, 2/pk	1.5/2.0ml	11mm	Eppendorf tube	96	30314891	733

Swing Out Rotors 16x50ml

Description	Item No.	Price USD
Rotor, Swing out, 16x50ml, ID	30314828	2019

Compatible to	FC5714	FC5718	FC5718R	FC5816	FC5816R
Max. Speed	-	-	-	4500 rpm	4500 rpm
Max. RCF	-	-	-	3735 xg	3735 xg



Accessories	Vol./Tube	Diameter	Tube type	No.of tubes/rotor	Item No.	Price USD
Rack, 4x50ml D29mm FA, 2/pk	50ml	29mm	Conical bottom	16	30304375	370
Rack, 10x15ml D17mm FA, 2/pk	15ml	17mm	Conical bottom	40	30314583	370
Rack, 12x4-10ml D16mm Vac/Sar, 2/pk	4-10ml	16mm	Vacutainer/Sarstedt	48	30314585	370
Rack, 14x5-7ml D13mm Vac/Sar, 2/pk	5-7ml	13mm	Vacutainer/Sarstedt	56	30314584	370

Open Air Shakers Selector Guide



Product Family	Light Duty Orbital Shaker	Light Duty Orbital Shaker	Light Duty Orbital Shaker	Light Duty Orbital Shaker
Model	SHLD0415AL	SHLD0403DG	SHLD0415DG	SHLDMP03DG
Speed Range	40 to 300 rpm	100 to 1200 rpm	40 to 300 rpm	100 to 1200 rpm
Timer	N/A	1 second to 160 hours	1 second to 160 hours	1 second to 160 hours
Motion	Orbital	Orbital	Orbital	Orbital
Orbit	15 mm	3 mm	15 mm	3 mm
Max Weight Capacity	8 lbs	8 lbs	8 lbs	4 microplates / 2 micro-tube racks
Audible Alarm	—	●	●	●
Load Sensor	—	—	—	—
Motor Type	Brushless DC Motor	Brushless DC Motor	Brushless DC Motor	Brushless DC Motor
CO ₂ Environment	●	●	●	●
Overload Protection	—	●	●	●
User Calibration (Speed)	—	—	—	—
RS232 Interface	—	—	—	—
Included Tray (L x W)	11.75 x 8.75"	11.75 x 8.75"	11.75 x 8.75"	11 x 7.75"
Tray / Platform Options (L x W)	N/A	Adjustable Platform	Adjustable Platform	N/A



Product Family	Extreme Environment Shakers	Heavy Duty Shaker	Heavy Duty Shaker	Heavy Duty Shaker
Model	SHEX1619DG	SHHD1619AL	SHHD1619DG	SHHD2325AL
Speed Range	15 to 500 rpm	25 to 500 rpm	15 to 500 rpm	25 to 500 rpm
Timer	1 second to 160 hours	1 to 120 minutes	1 second to 160 hours	1 to 120 minutes
Motion	Orbital	Orbital	Orbital	Orbital
Orbit	19 mm	19 mm	19 mm	25 mm
Max Weight Capacity	35 lbs	35 lbs	35 lbs	50 lbs
Audible Alarm	●	—	●	—
Load Sensor	●	—	●	—
Motor Type	Brushless DC Motor	Brushless DC Motor	Brushless DC Motor	Brushless DC Motor
CO ₂ Environment	●	●	●	●
Overload Protection	●	—	●	—
User Calibration (Speed)	●	—	●	—
RS232 Interface	●	—	●	—
Included Tray (L x W)	11 x 13"	11 x 13"	11 x 13"	18 x 24"
Tray / Platform Options (L x W)	11 x 13", 13 x 13", 18 x 18", 18 x 24" Adjustable Platform Separatory Funnel Platform	11 x 13", 13 x 13", 18 x 18", 18 x 24" Adjustable Platform Separatory Funnel Platform	11 x 13", 13 x 13", 18 x 18", 18 x 24" Adjustable Platform Separatory Funnel Platform	18 x 24", 18 x 30" Adjustable Platform Large Vessel Carrier Platform



Product Family	Heavy Duty Orbital Shaker	Heavy Duty Orbital Shaker	Heavy Duty Orbital Shaker	Heavy Duty Orbital Shaker	Heavy Duty Orbital Shaker
Model	SHHD2325DG	SHHD4525DG	SHHD4550DG	SHHD6825DG	SHHD6850DG
Speed Range	20 to 500 rpm	15 to 500 rpm	15 to 300 rpm	15 to 500 rpm	15 to 300 rpm
Timer	1 second to 160 hours	1 second to 160 hours	1 second to 160 hours	1 second to 160 hours	1 second to 160 hours
Motion	Orbital	Orbital	Orbital	Orbital	Orbital
Orbit	25 mm	25 mm	51 mm	25 mm	51 mm
Max Weight Capacity	50 lbs	100 lbs	100 lbs	150 lbs	150 lbs
Audible Alarm	●	●	●	●	●
Load Sensor	●	●	●	●	●
Motor Type	Brushless DC Motor	Brushless DC Motor	Brushless DC Motor	Brushless DC Motor	Brushless DC Motor
CO ₂ Environment	●	●	●	●	●
Overload Protection	●	●	●	●	●
User Calibration (Speed)	●	●	●	●	●
RS232 Interface	●	●	●	●	●
Included Tray (L x W)	18 x 24"	24 x 24"	24 x 24"	24 x 36"	24 x 36"
Tray / Platform Options (L x W)	18 x 24", 18 x 30" Adjustable Platform Large Vessel Carrier Platform	24 x 24" Large Vessel Carrier Platform	24 x 24" Large Vessel Carrier Platform	24 x 36" Large Vessel Carrier Platform	24 x 36" Large Vessel Carrier Platform



Product Family	Rocking Shaker	Rocking Shaker	Waving Shaker	Waving Shaker	Reciprocating Shaker
Model	SHRK04DG	SHRK07AL1	SHWV02DG	SHWV02AL	SHRC0719DG
Speed Range	1 to 50 rpm*	1 to 75 rpm*	1 to 30 rpm*	1 to 75 rpm*	20 to 300 rpm
Timer	1 second to 160 hours	1 minute to 120 minutes	1 second to 160 hours	1 minute to 120 minutes	1 second to 160 hours
Motion	Rocking	Rocking	Waving	Waving	Reciprocating
Orbit	Tilt Angle: 0 to 15°	Tilt Angle: 0 to 15°	Tilt Angle: 0 to 20° *	Tilt Angle: 0 to 16°	Stroke: 19 mm
Max Weight Capacity	10 lbs**	16 lbs**	5 lbs**	5 lbs**	15 lbs
Audible Alarm	●	—	●	—	●
Load Sensor	—	—	—	—	●
Motor Type	Stepper Motor	Stepper Motor	Stepper Motor	Stepper Motor	Brushless DC Motor
CO ₂ Environment	●	—	●	—	●
Overload Protection	●	—	●	—	●
User Calibration (Speed)	—	—	—	—	●
RS232 Interface	—	—	—	—	●
Included Tray (L x W)	12.75 x 10"	14 x 11"	11.75 x 8.75"	14 x 11"	11 x 13"
Tray / Platform Options (L x W)	Stacking Tray	Stacking Tray	Stacking Tray	—	11 x 13", 13 x 13", 18 x 18", 18 x 24" Separatory Funnel Platform

● Yes * Maximum speed/tilt angle may vary with heavy or unbalanced loads. ** Centered on tray.

Light Duty Orbital Shakers

- Variable speed microprocessor control
- Low profile design
- 15 mm orbit

The OHAUS Light Duty Analog Shaker is an economical shaker designed for educational labs or basic shaking applications.



Operating Features:

Low Profile Design: Takes up less space and easily fits into most hoods and incubators.

Microprocessor Control: The variable speed microprocessor control provides consistent uniform shaking action.

Triple Eccentric Drive: Permanently lubricated ball bearings and maintenance free, brushless DC motor provide reliable service and continuous duty operation.

Adjustment Knob: Basic speed knob with dial settings from 1 to 10.

Safety Features:

Speed Ramping Feature: Slowly increases speed to desired set-point to avoid splashing.

Spill-Resistant Design: Channels fluids away from internal components.

Operating Conditions:

Unit can be run in cold rooms, incubators, and CO₂ environments from 0 to 40°C (32 to 104°F), maximum 80% relative humidity, non-condensing.

Applications:

Blotting techniques, staining/destaining, and general shaking procedures.

Ordering Information:

Units include a detachable, 3-wire cord and plug. Units are also supplied with an 11.75 × 8.75" (29.9 × 22.2 cm) non-skid rubber mat.

Model	Speed Range	Orbit	Maximum Weight Capacity	Tray Material	Tray Dimensions (L × W)	Item No.	Price USD
SHLD0415AL	40 to 300 rpm	15 mm (0.6")	8 lbs (3.6 kg)	Aluminum	11.75 × 8.75" (29.9 × 22.2 cm)	30391891	1371

Light Duty Orbital Shakers

- General purpose shaker
- LED displays for speed and time
- 3 mm or 15 mm orbit

The OHAUS Digital Light Duty Orbital Shaker is ideal for a wide variety of shaking applications. Tray includes a non-skid rubber mat. Remove the mat to mount a variety of optional flask clamps or test tube racks directly onto the tray.

Operating Features:

Low Profile Design: Takes up less space and easily fits into most hoods and incubators.

Microprocessor Control: The variable speed microprocessor control provides consistent uniform shaking action. Microprocessor will display last set-point and will restart if power is interrupted.

Triple Eccentric Drive: Permanently lubricated ball bearings and maintenance free, brushless DC motor provide reliable service and continuous duty operation.

LED Display: Touchpad controls with easy-to-read, independent LED displays for speed and time allow operator to view both settings at once. Provides repeatable and accurate results every time and is easily visible across lab benches. Timer will display elapsed time or, when programmed to user defined limit, will shut off unit when time reaches zero. Display will show last used settings, even after power has been turned off.

Safety Features:

Overload Protection: Audible and visual signals will activate when system detects an obstruction or overload of the tray.

Speed Ramping Feature: Slowly increases speed to desired set-point to avoid splashing.

Audible Alarm: In timed mode, alarm will sound when the time reaches zero.

Spill-Resistant Design: Channels fluids away from internal components.

Operating Conditions:

Units can be run in cold rooms, incubators, and CO₂ environments.

SHLD0403DG: -10 to 60°C (14 to 140°F)

SHLD0415DG: -10 to 40°C (14 to 104°F)

Maximum 80% relative humidity, non-condensing.

Applications:

Cell cultures, immunoassays, and protein studies.

Ordering Information:

Units include a detachable, 3-wire cord and plug. Units are also supplied with an 11.75 × 8.75" (29.9 × 22.2 cm) non-skid rubber mat.



Model	Speed Range	Speed Accuracy	Timer	Orbit	Maximum Weight Capacity	Tray Material	Tray Dimensions (L × W)	Item No.	Price USD
SHLD0403DG	100 to 1200 rpm	+/-2% above 100 rpm	1 second to 160 hours	3 mm (0.12")	8 lbs (3.6 kg)	Aluminum	11.75 × 8.75" (29.9 × 22.2 cm)	30391898	1721
SHLD0415DG	40 to 300 rpm	+/-2 rpm below 100 rpm	1 second to 160 hours	15 mm (0.6")	8 lbs (3.6 kg)	Aluminum	11.75 × 8.75" (29.9 × 22.2 cm)	30391912	1831

Light Duty Orbital Shakers

- Holds up to 4 microplates or 2 micro-tube racks
- Accepts deep well plates
- Timer with audible alarm

The OHAUS Microplate Shaker is ideal for immunoassays and general microplate shaking, and is designed to be used in a variety of environmental conditions.



Operating Features:

Low Profile Design: Takes up less space and easily fits into most hoods and incubators. Base offers durability and added stability.

Microprocessor Control: The variable speed microprocessor control provides consistent uniform shaking action. Microprocessor will display last set-point and will restart if power is interrupted.

Triple Eccentric Drive: Permanently lubricated ball bearings and maintenance free, brushless DC motor provide reliable service and continuous duty operation.

LED Display: Touchpad controls with easy-to-read, independent LED displays for speed and time allow operator to view all settings at once. Provides repeatable and accurate results every time and is easily visible across lab benches. Timer will display elapsed time or, when programmed to user defined limit, will shut off unit when time reaches zero. Display will show last used settings, even after power has been turned off.

Safety Features:

Overload Protection: Audible and visual signals will activate when system detects an obstruction or overload of the tray.

Speed Ramping Feature: Slowly increases speed to desired set-point to avoid splashing.

Audible Alarm: In timed mode, alarm will sound when the time reaches zero.

Spill-Resistant Design: Channels fluids away from internal components.

Operating Conditions:

Unit can be run in cold rooms, incubators, and CO₂ environments from -10 to 60°C (14 to 140°F), maximum 80% relative humidity, non-condensing.

Applications:

ELISA assays and DNA studies.

Ordering Information:

Units include a detachable, 3-wire cord and plug.

Model	Speed Range	Speed Accuracy	Timer	Orbit	Maximum Weight Capacity	Tray Material	Tray Dimensions (L x W)	Item No.	Price USD
SHLDMP03DG	100 to 1200 rpm	± 2%	1 second to 160 hours	3 mm (0.12")	4 microplates or 2 micro-tube racks	Aluminum	11 × 7.75" (27.9 × 19.7 cm)	30391905	1393

Extreme Environment Shakers

- Designed for use in CO₂ Incubators
- Can withstand extreme environments up to 100% humidity
- Remote controller magnetically attaches to most incubators

The OHAUS Extreme Environment Orbital Shaker is designed for a wide range of applications including cell cultures that require CO₂ and humidity for optimal cell growth. The microprocessor control provides consistent uniform shaking while safely ramping to the set speed.

Operating Features:

Accu-Drive Shaking System: The exclusive patented Accu-Drive Shaking System delivers exceptional speed control, accuracy, and durability. The shaking system continuously monitors shaking speed and maintains set-point, even under changing loads. When unit is set to a speed above 100 rpm, the speed accuracy is $\pm 1\%$ of set speed. When set under 100 rpm, speed accuracy is ± 1 rpm.

Microprocessor Control: The variable speed microprocessor control provides consistent uniform shaking action. Microprocessor will display last set-point and will restart if power is interrupted.

Triple Eccentric Drive: Permanently lubricated ball bearings and maintenance free, brushless DC motor provide reliable service and continuous duty operation.

Remote Controller: The control module is designed to sit outside of the incubator. Settings can be easily viewed or changed from outside of the incubator without disturbing the incubator's atmosphere. The thin ribbon cable is 5.5 feet long and easily passes underneath an incubator door via incubator's utility port. Controller magnetically attaches to most incubator doors or can sit on a lab bench.

LED Display: Touchpad controls with easy-to-read, independent LED displays for speed and time allow operator to view both settings at once. Provides repeatable and accurate results every time and is easily visible across lab benches. Timer will display elapsed time or, when programmed to user defined limit, will shut off unit when time reaches zero. Display will show last used settings, even after power has been turned off.

RS232 Interface: Provides two-way communication for data logging and unit control.

Speed Calibration Mode: Allows user to automatically recalibrate speed display.

Safety Features:

Overload Protection: Audible and visual signals will activate when system detects an obstruction.

Speed Ramping Feature: Slowly increases speed to desired set-point to avoid splashing.

Audible Alarm: In timed mode, alarm will sound when the time reaches zero. Alarm has optional mute function which can be set from the Touchpad control.

Spill-Resistant Design: Channels fluids away from internal components.

Operating Conditions:

Unit can be run in cold rooms, incubators, and CO₂ environments from -10 to 60°C (14 to 140°F), up to 100% humidity.

Applications:

Cell cultures, solubility studies, and extraction procedures.

Ordering Information:

Unit includes a detachable, 3-wire cord and plug. Unit is also supplied with an 11 × 13" (27.9 × 33 cm) non-skid rubber mat.



Model	Speed Range	Speed Accuracy	Timer	Orbit	Maximum Weight Capacity	Tray Material	Tray Dimensions (L × W)	Item No.	Price USD
SHEX1619DG	15 to 500 rpm	above 100 rpm $\pm 1\%$ of set speed below 100 rpm ± 1 rpm	1 second to 160 hours	0.75" (19 mm)	35 lbs (16 kg)	Aluminum	11 × 13" (27.9 × 33 cm)	30391809	3618

Heavy Duty Orbital Shakers

- Microprocessor controls
- Continuous or timed operation
- 35 lb weight capacity

The OHAUS 16 kg Capacity Analog Heavy Duty Orbital Shaker is designed for a wide range of applications that require basic shaking control. Shaker provides reproducible motion that is evenly distributed throughout the entire surface of the tray.

Operating Features:

Microprocessor Control: The variable speed microprocessor control provides consistent uniform shaking action. The shaker will automatically restart after a power interruption.

Triple Eccentric Drive: Permanently lubricated ball bearings and maintenance free, brushless DC motor provide reliable service and continuous duty operation.

Adjustment Knobs: Basic speed and time knobs with dial settings from 1 to 10.

Safety Features:

Speed Ramping Feature: Slowly increases speed to desired set-point to avoid splashing.

Spill-Resistant Design: Channels fluids away from internal components.

Operating Conditions:

Unit can be run in cold rooms, incubators, and CO₂ environments from 0 to 40°C (32 to 104°F), maximum 80% relative humidity, non-condensing.

Applications:

Bacterial suspensions, staining/destaining, and general mixing.

Ordering Information:

Unit includes a detachable, 3-wire cord and plug. Unit is also supplied with an 11 × 13" (27.9 × 33 cm) non-skid rubber mat.



Model	Speed Range	Timer	Orbit	Maximum Weight Capacity	Tray Material	Tray Dimensions (L × W)	Item No.	Price USD
SHHD1619AL	25 to 500 rpm	1 minute to 120 minutes	19 mm (0.75")	35 lbs (16 kg)	Aluminum	11 × 13" (27.9 × 33 cm)	30391307	2180

Heavy Duty Orbital Shakers

- Exceptional speed control, accuracy and durability
- LED displays for speed and time
- Calibration mode for speed

The OHAUS 16 kg Capacity Digital Heavy Duty Orbital Shaker is designed for a wide range of applications, including cell cultures, that require accurate and repeatable results. The microprocessor control provides consistent uniform shaking while safely ramping to the set speed.

Operating Features:

Accu-Drive Shaking System: The exclusive patented Accu-Drive Shaking System delivers exceptional speed control, accuracy, and durability. The shaking system continuously monitors shaking speed and maintains set-point, even under changing loads. When unit is set to a speed above 100 rpm, the speed accuracy is $\pm 1\%$ of set speed. When set under 100 rpm, speed accuracy is ± 1 rpm.

Microprocessor Control: The variable speed microprocessor control provides consistent uniform shaking action. Microprocessor will display last set-point and will restart if power is interrupted.

Triple Eccentric Drive: Permanently lubricated ball bearings and maintenance free, brushless DC motor provide reliable service and continuous duty operation.

LED Display: Touchpad controls with easy-to-read, independent LED displays for speed and time allow operator to view both settings at once. Provides repeatable and accurate results every time and is easily visible across lab benches. Timer will display elapsed time or, when programmed to user defined limit, will shut off unit when time reaches zero. Display will show last used settings, even after power has been turned off.

RS232 Interface: Provides two-way communication for data logging and unit control.

Speed Calibration Mode: Allows user to automatically recalibrate speed display.

Safety Features:

Load Sensor: A built-in load sensor detects unbalanced conditions and automatically reduces rpm to a safe speed to protect samples.

Overload Protection: Audible and visual signals will activate when system detects an obstruction or overload of the tray.

Speed Ramping Feature: Slowly increases speed to desired set-point to avoid splashing.

Audible Alarm: In timed mode, alarm will sound when the time reaches zero. Alarm has optional mute function which can be set from the Touchpad control.

Spill-Resistant Design: Channels fluids away from internal components.

Operating Conditions:

Unit can be run in cold rooms, incubators, and CO₂ environments from -10 to 60°C (14 to 140°F), maximum 80% relative humidity, non-condensing.

Applications:

Cell cultures, solubility studies, and extraction procedures.

Ordering Information:

Unit includes a detachable, 3-wire cord and plug. Unit is also supplied with an 11 × 13" (27.9 × 33 cm) non-skid rubber mat.



Model	Speed Range	Speed Accuracy	Timer	Motion Advanced 3500, orbital Advanced 3750, reciprocating	Maximum Weight Capacity Advanced 3500	Tray Material	Tray Dimensions (L × W)	Item No.	Price USD
SHHD1619DG	15 to 500 rpm	above 100 rpm $\pm 1\%$ of set speed below 100 rpm ± 1 rpm	1 second to 160 hours	19 mm (0.75") orbit 19 mm (0.75") stroke	35 lbs (16 kg)	Aluminum	11 × 13" (27.9 × 33 cm)	30391807	2889

Heavy Duty Orbital Shakers

- Microprocessor controls
- Continuous or timed operation
- 50 lb weight capacity

The OHAUS Analog 23 kg Capacity Heavy Duty Orbital Shaker is designed for applications with heavy duty loads. Shaker provides reproducible motion that is evenly distributed throughout the entire surface of the tray.

Operating Features:

Microprocessor Control: The variable speed microprocessor control provides consistent uniform shaking action. The shaker will automatically restart after a power interruption.

Triple Eccentric Drive: Permanently lubricated ball bearings and maintenance free, brushless DC motor provide reliable service and continuous duty operation.

Adjustment Knobs: Basic speed and time knobs with dial settings from 1 to 10.

Safety Features:

Speed Ramping Feature: Slowly increases speed to desired set-point to avoid splashing.

Spill-Resistant Design: Channels fluids away from internal components.

Operating Conditions:

Unit can be run in cold rooms, incubators, and CO₂ environments from 0 to 40°C (32 to 104°F), maximum 80% relative humidity, non-condensing.

Applications:

Bacterial suspensions, staining/destaining, and general mixing.

Ordering Information:

Units include a 3-wire cord and plug. Units are also supplied with an 18 × 24" (45.7 × 61 cm) non-skid rubber mat.

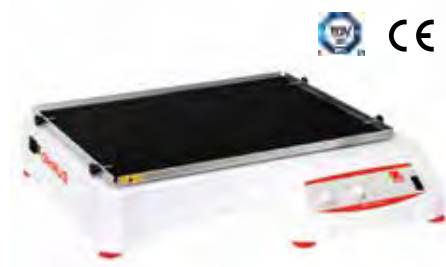

Model	Speed Range	Timer	Orbit	Maximum Weight Capacity	Tray Material	Tray Dimensions (L × W)	Item No.	Price USD
SHHD2325AL	25 to 500 rpm	1 minute to 120 minutes	25 mm (1")	50 lbs (22.7 kg)	Aluminum	18 × 24" (45.7 × 61 cm)	30391835	5072

Heavy Duty Orbital Shakers

- Patented Accu-Drive Shaking System
- LED displays for speed and time
- 50 lb weight capacity

The OHAUS Digital 23 kg Capacity Heavy Duty Orbital Shaker is designed for a wide range of applications with larger or heavier loads that require accurate and repeatable results.



Operating Features:

Accu-Drive Shaking System: The exclusive patented Accu-Drive Shaking System delivers exceptional speed control, accuracy, and durability. The shaking system continuously monitors shaking speed and maintains set-point, even under changing loads. When unit is set to a speed above 100 rpm, the speed accuracy is $\pm 1\%$ of set speed. When set under 100 rpm, speed accuracy is ± 1 rpm.

Microprocessor Control: The variable speed microprocessor control provides consistent uniform shaking action. Microprocessor will display last set-point and will restart if power is interrupted.

Triple Eccentric Drive: Permanently lubricated ball bearings and maintenance free, brushless DC motor provide reliable service and continuous duty operation.

LED Display: Touchpad controls with easy-to-read, independent LED displays for speed and time allow operator to view both settings at once. Provides repeatable and accurate results every time and is easily visible across lab benches. Timer will display elapsed time or, when programmed to user defined limit, will shut off unit when time reaches zero. Display will show last used settings, even after power has been turned off.

RS232 Interface: Provides two-way communication for data logging and unit control.

Speed Calibration Mode: Allows user to automatically recalibrate speed display.

Safety Features:

Load Sensor: A built-in load sensor detects unbalanced conditions and automatically reduces rpm to a safe speed to protect samples.

Overload Protection: Audible and visual signals will activate when system detects an obstruction or overload of the tray.

Speed Ramping Feature: Slowly increases speed to desired set-point to avoid splashing.

Audible Alarm: In timed mode, alarm will sound when the time reaches zero. Alarm has optional mute function which can be set from the Touchpad control.

Spill-Resistant Design: Channels fluids away from internal components.

Operating Conditions:

Unit can be run in cold rooms, incubators, and CO₂ environments from -10 to 60°C (14 to 140°F), maximum 80% relative humidity, non-condensing.

Applications:

Cell cultures, solubility studies, and extraction procedures.

Ordering Information:

Units include a detachable, 3-wire cord and plug. Units are also supplied with an 18 × 24" (45.7 × 61 cm) non-skid rubber mat.

Model	Speed Range	Speed Accuracy	Timer	Orbit	Maximum Weight Capacity	Tray Material	Tray Dimensions (L × W)	Item No.	Price USD
SHHD2325DG	20 to 500 rpm	above 100 rpm $\pm 1\%$ of set speed below 100 rpm ± 1 rpm	1 second to 160 hours	25 mm (1")	50 lbs (22.7 kg)	Aluminum	18 × 24" (45.7 × 61 cm)	30391842	5315

Heavy Duty Orbital Shakers

- Patented Accu-Drive Shaking System
- 100 lb weight capacity
- Available with either 25 or 51 mm orbit



The OHAUS Digital 45 kg Capacity Orbital Shaker is a large capacity shaker. They have a more powerful drive mechanism and larger orbits for optimal shaking of large vessels.

Operating Features:

Accu-Drive Shaking System: The exclusive patented Shaking System delivers exceptional speed control, accuracy, and durability. The shaking system continuously monitors shaking speed and maintains set-point, even under changing loads. When unit is set to a speed above 100 rpm, the speed accuracy is $\pm 1\%$ of set speed. When set under 100 rpm, speed accuracy is ± 1 rpm.

Microprocessor Control: The variable speed microprocessor control provides consistent uniform shaking action. Microprocessor will display last set-point and will restart if power is interrupted.

Triple Eccentric Drive: Permanently lubricated ball bearings and maintenance free, brushless DC motor provide reliable service and continuous duty operation.

LED Display: Touchpad controls with easy-to-read, independent LED displays for speed and time allow operator to view both settings at once. Provides repeatable and accurate results every time and is easily visible across lab benches. Timer will display elapsed time or, when programmed to user defined limit, will shut off unit when time reaches zero. Display will show last used settings, even after power has been turned off.

RS232 Interface: Provides two-way communication for data logging and unit control.

Speed Calibration Mode: Allows user to automatically recalibrate speed display.

Safety Features:

Load Sensor: A built-in load sensor detects unbalanced conditions and automatically reduces rpm to a safe speed to protect samples.

Overload Protection: Audible and visual signals will activate when system detects an obstruction or overload of the tray.

Speed Ramping Feature: Slowly increases speed to desired set-point to avoid splashing.

Audible Alarm: In timed mode, alarm will sound when the time reaches zero. Alarm has optional mute function which can be set from the Touchpad control.

Spill-Resistant Design: Channels fluids away from internal components.

Operating Conditions:

Units can be run in cold rooms, incubators, and CO₂ environments from -10 to 60°C (14 to 140°F), maximum 80% relative humidity, non-condensing.

Applications:

Cell cultures, solubility studies, and extraction procedures.

Ordering Information:

Units include a detachable, 3-wire cord and plug. Units are also supplied with a 24 x 24" (61 x 61 cm) non-skid rubber mat.

Model	Speed Range	Speed Accuracy	Timer	Orbit	Maximum Weight Capacity	Tray Material	Tray Dimensions (L x W)	Item No.	Price USD
SHHD4525DG	15 to 500 rpm	above 100 rpm $\pm 1\%$ of set speed below 100 rpm ± 1 rpm	1 second to 160 hours	25 mm (1")	100 lbs (45.4 kg)	Aluminum	24 x 24" (61 x 61 cm)	30391863	6824
SHHD4550DG	15 to 300 rpm			51 mm (2")				30391870	7049

Heavy Duty Orbital Shakers

- Patented Accu-Drive Shaking System
- Available with either 25 or 51 mm orbit
- Calibration mode for speed



The OHAUS Digital 68 kg Capacity Orbital Shakers is the largest capacity shakers designed for the heaviest of loads. They have the most powerful drive mechanism of all the shakers and large orbits for optimal shaking of larger vessels.

Operating Features:

Accu-Drive Shaking System: The exclusive patented Accu-Drive Shaking System delivers exceptional speed control, accuracy, and durability. The system continuously monitors shaking speed and maintains set-point, even under changing loads. When unit is set to a speed above 100 rpm, the speed accuracy is $\pm 1\%$ of set speed. When set under 100 rpm, speed accuracy is ± 1 rpm.

Microprocessor Control: The variable speed microprocessor control provides consistent uniform shaking action. Microprocessor will display last set-point and will restart if power is interrupted.

Triple Eccentric Drive: Permanently lubricated ball bearings and maintenance free, brushless DC motor provide reliable service and continuous duty operation.

LED Display: Touchpad controls with easy-to-read, independent LED displays for speed and time allow operator to view both settings at once. Provides repeatable and accurate results every time and is easily visible across lab benches. Timer will display elapsed time or, when programmed to user defined limit, will shut off unit when time reaches zero. Display will show last used settings, even after power has been turned off.

RS232 Interface: Provides two-way communication for data logging and unit control.

Speed Calibration Mode: Allows user to automatically recalibrate speed display.

Safety Features:

Load Sensor: A built-in load sensor detects unbalanced conditions and automatically reduces rpm to a safe speed to protect samples.

Overload Protection: Audible and visual signals will activate when system detects an obstruction or overload of the tray.

Speed Ramping Feature: Slowly increases speed to desired set-point to avoid splashing.

Audible Alarm: In timed mode, alarm will sound when the time reaches zero. Alarm has optional mute function which can be set from the Touchpad control.

Spill-Resistant Design: Channels fluids away from internal components.

Operating Conditions:

Units can be run in cold rooms, incubators, and CO₂ environments from -10 to 60°C (14 to 140°F), maximum 80% relative humidity, non-condensing.

Applications:

Cell cultures, solubility studies, and extraction procedures.

Ordering Information:

Units include a detachable, 3-wire cord and plug. Units are also supplied with a 24 × 36" (61 × 91 cm) non-skid rubber mat.



Model	Speed Range	Speed Accuracy	Timer	Orbit	Maximum Weight Capacity	Tray Material	Tray Dimensions (L × W)	Item No.	Price USD
SHHD6825DG	15 to 500 rpm	above 100 rpm $\pm 1\%$ of set speed below 100 rpm ± 1 rpm	1 second to 160 hours	25 mm (1")	150 lbs (68 kg)	Aluminum	24 × 36" (61 × 91 cm)	30391877	7699
SHHD6850DG	15 to 300 rpm			51 mm (2")				30391884	8735

Rocking & Waving Shakers

- Variable control for speed, tilt and time
- 16 lb capacity
- Two-tier model doubles workable capacity

The OHAUS Analog Rocking Shaker is an easy and economical option for all of your rocking needs. The Rocking Shaker is ideal for cell culture and blotting applications and is designed to be used in a variety of environmental conditions. Rocker is supplied with an 14 × 11" (35.6 × 27.9 cm) non-skid rubber mat.

Operating Features:

Low Profile Design: Takes up less bench space and fits into most hoods and incubators. Two-tier option increases the capacity with the same footprint and provides a 3.5" (8.9 cm) clearance between platforms. Cast aluminum base offers durability and added stability

Microprocessor Control: The microprocessor control provides tilt adjustment which allows user to easily adjust rocking angle from 0 to 15° while unit is operating. Smooth speed control with low speed rocking motion.

Independent Control Knobs: Independent control knobs for speed, tilt, and time, allow for easy adjustments.

Safety Features:

Overload Protection: Audible signal will activate when system detects an obstruction or overload of the tray.

Speed Ramping Feature: Slowly increases speed to desired set-point to avoid splashing.

Timer: Timer will automatically stop rocking motion when timer reaches zero.

Spill-Resistant Design: Channels fluids away from internal components.

Operating Conditions:

Unit can be run in cold rooms, incubators, and CO₂ environments from -10 to 60°C (14 to 140°F), maximum 80% relative humidity, non-condensing.

Applications:

Staining and destaining gels, hybridization procedures, hematology, and blotting techniques.

Ordering Information:

Units include a detachable, 3-wire cord and plug. Units are also supplied with a 14 × 11" (35.6 × 27.9 cm) non-skid rubber mat. Two-tier models include a 2nd tray, non-skid mat and hardware.

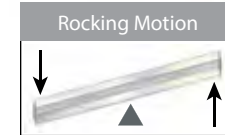

Model	Speed Range	Tilt Angle	Timer	Maximum Weight Capacity	Tray Material	Tray Dimensions (L × W)	Item No.	Price USD
SHRK07AL1	1 to 75 rpm*	0 to 15°*	1 minute to 120 minutes	16 lbs (7.3 kg)**	Aluminum	14 × 11" (35.6 × 27.9 cm)	30391959	1112
SHRK07AL2							30391966	1190

* Maximum speed/tilt angle may vary with heavy or unbalanced loads.

** Centered on tray.

Rocking & Waving Shakers

- Electronic tilt adjustment from 0 to 15° while unit is operating
- Displays for speed, tilt angle and time
- Timer with audible alarm

The OHAUS Digital Rocking Shaker is ideal for cell culture work and is designed to be used in a variety of environmental conditions.

Operating Features:

Low Profile Design: Takes up less space and easily fits into most hoods and incubators. Cast aluminum base offers durability and added stability.

Microprocessor Control: The microprocessor control provides electronic tilt angle adjustment which allows user to easily adjust rocking angle from 0 to 15° while unit is operating. Precise speed control provides smooth, low-speed rocking motion down to 1 rpm.

LED Display: Touchpad controls with easy-to-read, independent LED displays for speed and tilt angle, and time allow operator to view all settings at once. Provides repeatable and accurate results every time and is easily visible across lab benches. Timer will display elapsed time or, when programmed to user defined limit, will shut off unit when time reaches zero. Display will show last used settings, even after power has been turned off.

Safety Features:

Overload Protection: Audible and visual signals will activate when system detects an obstruction or overload of the tray.

Speed Ramping Feature: Slowly increases speed to desired set-point to avoid splashing.

Audible Alarm: In timed mode, alarm will sound when the time reaches zero.

Spill-Resistant Design: Channels fluids away from internal components.

Operating Conditions:

Unit can be run in cold rooms, incubators, and CO₂ environments from -10 to 60°C (14 to 140°F), maximum 80% relative humidity, non-condensing.

Applications:

Staining and destaining gels, hybridization procedures, hematology, and blotting techniques.

Ordering Information:

Units include a detachable, 3-wire cord and plug. Units are also supplied with a 12.75 × 10" (32.4 × 25.4 cm) non-skid rubber mat.



Model	Speed Range	Speed Accuracy	Tilt Angle	Timer	Maximum Weight Capacity	Tray Material	Tray Dimensions (L × W)	Item No.	Price USD
SHRK04DG	1 to 50 rpm*	± 1 rpm	0 to 15°*	1 second to 160 hours	10 lbs (4.5 kg)**	Aluminum	12.75 × 10" (32.4 × 25.4 cm)	30391994	1365

* Maximum speed/tilt angle may vary with heavy or unbalanced loads.

** Centered on tray.

Rocking & Waving Shakers

- Variable control for speed, tilt and time
- 5 lb capacity
- Large 14 × 11" tray

The OHAUS Analog Waving Shakers are an easy and economical option for all of your waving needs. Ideal for cell culture and blotting applications, and is designed to be used in a variety of environmental conditions.

Operating Features:

Low Profile Design: Takes up less space and easily fits into most hoods and incubators. Cast aluminum base offers durability and added stability.

Microprocessor Control: Provides tilt adjustment which allows user to easily adjust waving angle from 0 to 16° while unit is operating. Smooth speed control with low speed waving motion.

Independent Control Knobs: Independent control knobs for speed, tilt and time allow for easy adjustments.

Safety Features:

Overload Protection: Audible and visual signals will activate when system detects an obstruction or overload of the tray.

Speed Ramping Feature: Slowly increases speed to desired set-point to avoid splashing.

Timer: Timer, if engaged, will automatically stop waving motion when timer reaches zero.

Spill-Resistant Design: Channels fluids away from internal components.

Operating Conditions:

Unit can be run in cold rooms, incubators, and environments from -10 to 60°C (14 to 140°F), maximum 80% relative humidity, non-condensing.

Applications:

Staining and destaining gels, hybridization procedures, hematology, and blotting techniques.

Ordering Information:

Units include a detachable, 3-wire cord and plug. Units are also supplied with a 14 × 11" (35.6 × 27.9 cm) non-skid rubber mat.

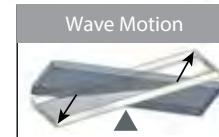

Model	Speed Range	Tilt Angle	Timer	Maximum Weight Capacity	Tray Material	Tray Dimensions (L × W)	Item No.	Price USD
SHWV02AL	1 to 75 rpm*	0 to 16°*	1 minute to 120 minutes	5 lbs (2.3 kg)**	Aluminum	14 × 11" (35.6 × 27.9 cm)	30391973	1533

* Maximum speed/tilt angle may vary with heavy or unbalanced loads.

** Centered on tray.

Rocking & Waving Shakers

- Electronic tilt adjustment from 0 to 20° while unit is operating
- Displays for speed and tilt angle, and time
- Timer with audible alarm

The OHAUS Digital Waving Shaker provides precise speed control and a smooth, low foaming, three dimensional, "wave" motion. Ideal for use in a wide range of laboratory applications and designed to be used in a variety of environmental conditions. Tray includes a non-skid rubber mat that is suitable for holding Petri dishes.

Operating Features:

Low Profile Design: Takes up less space and easily fits into most hoods and incubators. Cast aluminum base offers durability and added stability.

Microprocessor Control: The microprocessor control provides electronic tilt angle adjustment which allows user to easily adjust waving angle from 0 to 20° while unit is operating. Precise speed control provides smooth, low-speed waving motion down to 1 rpm.

LED Display: Touchpad controls with easy-to-read, independent LED displays for speed and tilt angle, and time allow operator to view all settings at once. Provides repeatable and accurate results every time and is easily visible across lab benches. Timer will display elapsed time or, when programmed to user defined limit, will shut off unit when time reaches zero. Display will show last settings, even after power has been turned off.

Safety Features:

Overload Protection: Audible and visual signals will activate when system detects an obstruction or overload of the tray.

Speed Ramping Feature: Slowly increases speed to desired set-point to avoid splashing.

Audible Alarm: In timed mode, alarm will sound when the time reaches zero.

Spill-Resistant Design: Channels fluids away from internal components.

Operating Conditions:

Unit can be run in cold rooms, incubators, and CO₂ environments from -10 to 60°C (14 to 140°F), maximum 80% relative humidity, non-condensing.

Applications:

Blood samples, DNA extractions, blotting techniques, and general mixing of various size tubes.

Ordering Information:

Units include a detachable, 3-wire cord and plug. Units are also supplied with an 11.75 × 8.75" (29.9 × 22.2 cm) non-skid rubber mat.

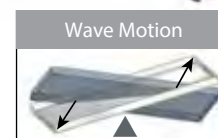

Model	Speed Range	Speed Accuracy	Tilt Angle	Timer	Maximum Weight Capacity	Tray Material	Tray Dimensions (L × W)	Item No.	Price USD
SHWV02DG	1 to 30 rpm*	± 1 rpm	0 to 20°*	1 second to 160 hours	5 lbs (2.3 kg)**	Aluminum	11.75 × 8.75" (29.9 × 22.2 cm)	30391947	1664

* Maximum speed/tilt angle may vary with heavy or unbalanced loads.

** Centered on tray.

Reciprocating Shakers

- Exceptional speed control, accuracy and durability
- LED displays for speed and time
- Calibration mode for speed

The OHAUS Digital Reciprocating Shakers are designed for a wide range of applications, including cell cultures, that require accurate and repeatable results. The microprocessor control provides consistent uniform shaking while safely ramping to the set speed.



Operating Features:

The shaking system in both models continuously monitors shaking speed and maintains set-point, even under changing loads. When unit is set to a speed above 100 rpm, the speed accuracy is $\pm 1\%$ of set speed. When set under 100 rpm, speed accuracy is ± 1 rpm.

Microprocessor Control: The variable speed microprocessor control provides consistent uniform shaking action. Microprocessor will display last set-point and will restart if power is interrupted.

Single Eccentric Drive: Permanently lubricated ball bearings and maintenance free, brushless DC motor provide reliable service and continuous duty operation. **LED Display:** Touchpad controls with easy-to-read, independent LED displays for speed and time allow operator to view both settings at once. Provides repeatable and accurate results every time and is easily visible across lab benches. Timer will display elapsed time or, when programmed to user defined limit, will shut off unit when time reaches zero. Display will show last used settings, even after power has been turned off.

RS232 Interface: Provides two-way communication for data logging and unit control.

Speed Calibration Mode: Allows user to automatically recalibrate speed display.

Safety Features:

Load Sensor: A built-in load sensor detects unbalanced conditions and automatically reduces rpm to a safe speed to protect samples.

Overload Protection: Audible and visual signals will activate when system detects an obstruction or overload of the tray.

Speed Ramping Feature: Slowly increases speed to desired set-point to avoid splashing.

Audible Alarm: In timed mode, alarm will sound when the time reaches zero. Alarm has optional mute function which can be set from the Touchpad control.

Spill-Resistant Design: Channels fluids away from internal components.

Operating Conditions:

Unit can be run in cold rooms, incubators, and CO₂ environments from -10 to 60°C (14 to 140°F), maximum 80% relative humidity, non-condensing.

Applications:

Cell cultures, solubility studies, and extraction procedures.

Ordering Information:

Unit includes a detachable, 3-wire cord and plug. Unit is also supplied with an 11 × 13" (27.9 × 33 cm) non-skid rubber mat.

Model	Speed Range	Speed Accuracy	Timer	Stroke	Maximum Weight Capacity	Tray Material	Tray Dimensions (L × W)	Item No.	Price USD
SHRC0719DG	20 to 300 rpm	above 100 rpm $\pm 1\%$ of set speed below 100 rpm ± 1 rpm	1 second to 160 hours	19 mm (0.75")	15 lbs (6.8 kg)	Aluminum	11 × 13" (27.9 × 33 cm)	30391828	2767

Incubating & Incubating Cooling Selector Guide



Product Family	Incubating Cooling Thermal Shakers	Incubating Light Duty Orbital Shaker	Incubating Light Duty Orbital Shakers
Model	ISTHBLCTS (Heat/Cool) ISTHBLHTS (Heat)	ISLD04HDG	ISLDMPHDG ISLDMPHDGL
Temperature Range	17 below ambient to 100°C / ambient +4 to 100°C	Ambient +5° to 65°C	Ambient +5° to 65°C
Speed Range	300 to 3000 rpm	100 to 1200 rpm	100 to 1200 rpm
Timer	1 minute to 99 hours, 59 min	1 second to 160 hours	1 second to 160 hours
Motion	Orbital	Orbital	Orbital
Orbit	3 mm	3 mm	3 mm
Max Weight Capacity	1 Block	8 lbs	4 Microplates / 2 Micro-Tube Racks
Audible Alarm	●	●	●
Load Sensor	●	—	—
Drive System	—	Triple Eccentric	Triple Eccentric
Motor Type	Brushless DC Motor	Brushless DC Motor	Brushless DC Motor
Set-Point Retention	● Displays Last Setting	● Displays Last Setting	● Displays Last Setting
Restart/Power Out	●	●	●
Ramp to Speed	●	●	●
Temperature Overshoot Protection	●	—	—
Overload Protection	●	●	●
User Calibration (Temperature)	●	●	●
User Calibration (Speed)	●	—	—
Interface	USB	—	—
Overall Dimensions (L x W x H)	10.59 x 10.31 x 5.39"	17 x 11 x 10.5"	17 x 11 x 7.75"
Included Tray (L x W)	N/A	11 x 7.75"	11 x 7.75"
Platform Options (L x W)	N/A	N/A	N/A

Incubating & Incubating Cooling Selector Guide



Product Family	Incubating Cooling Light Duty Orbital Shaker	Incubating Rocking Shaker	Incubating Waving Shaker
Model	ISICMBCDG	ISRK04HDG	ISWV02HDG
Temperature Range	10°C Below Ambient to 65°C	Ambient +5° to 65°C	Ambient +5° to 65°C
Speed Range	100 to 1200 rpm	1 to 50 rpm	1 to 30 rpm
Timer	1 second to 160 hours	1 second to 160 hours	1 second to 160 hours
Motion	Orbital	Rocking	Waving
Orbit	3 mm	Tilt Angle: 0 to 15° *	Tilt Angle: 0 to 20° *
Max Weight Capacity	2 Microplates 2 Modular Blocks	10 lbs**	5 lbs**
Audible Alarm	●	●	—
Load Sensor	—	—	—
Drive System	Triple Eccentric	Cable	Cable
Motor Type	Brushless DC Motor	Stepper Motor	Stepper Motor
Set-Point Retention	● Displays Last Setting	● Displays Last Setting	● Displays Last Setting
Restart/Power Out	●	●	—
Ramp to Speed	●	●	—
Temperature Overshoot Protection	—	—	—
Overload Protection	●	●	—
User Calibration (Temperature)	—	—	—
User Calibration (Speed)	—	—	—
Interface	—	—	—
Overall Dimensions (L x W x H)	16.49 x 10.11 x 10.98"	17 x 11 x 10.5"	17 x 11 x 10.5"
Included Tray (L x W)	N/A	10 x 7.5"	9.25 x 7.25"
Platform Options (L x W)	N/A	N/A	N/A

● Yes * Maximum speed/tilt angle may vary with heavy or unbalanced loads.
** Centered on tray.

Incubating Cooling Thermal Shakers

- 4.3" color LCD touchscreen display provides an intuitive interface
- Rapid heating, cooling and high speed shaking ability
- Internal memory stores five separate 5-step programs, unlimited with USB



The OHAUS Thermal Shakers and Cooling Thermal Shakers are designed for applications that require consistent and precise results. With heating, cooling and shaking capabilities. These shakers use interchangeable blocks to accommodate a wide variety of tubes and microplates. The easy-to-use, 4.3", color, LCD touchscreen allows the user to save and visibly track progress through the live status bar for five user defined programs, each with five individual steps. The unit's enhanced electronics and dual temperature sensors provide accurate, dependable temperature settings across the operating range.

Operating Features:

Low Profile Design: The low profile design minimizes the unit's footprint on the bench.

LCD Touchscreen: Enables faster setting of temperature, speed, and time which can all be viewed at once. Display features on-screen help topics with operational tips available in six languages. Touchscreen is compatible with rubber gloves used in labs. USB port can transfer information to a flash drive for data logging, program storage and software updates.

Program Control: Program control capabilities allow user programmable operation for automated use and memory. Storage for five separate 5-step programs, or unlimited number of programs with the use of the USB.

Temperature ramp rate: Adjustable temperature ramp rate feature separately defines the heating and cooling rate in increments of 0.5°C/min.

Single Point Calibration Mode: For maximum temperature accuracy, the single point calibration procedure allows the user to calibrate up to 6 different user defined temperatures.

Pulse Mode Feature: The unit is equipped with a pulse mode feature for quick vortex applications.

Safety Features:

Cool Touch Housing: Constructed from a high-quality, heat and chemical resistant polymer. The unit's housing remains cool to the touch throughout normal operating temperatures.

Maximum Temperature Limiting Function: Ensures the temperature will not exceed preset limits, allowing the user control of temperature sensitive samples.

Hot Top Indicator: A hot top warning light will illuminate when the temperature reaches 40°C, and will remain lit until the unit is sufficiently cooled.

Audible Alarm: In timed mode, an alarm will sound when the time reaches zero or set-point temperature is reached. Additionally, the heat function will automatically shut off if the unit recognizes an internal issue.

Automatic Block Recognition:

The unit will read the specific block being used and prevents potential over-speed programming.

Operating Conditions:

Unit can operate in conditions from 5 to 35°C (41 to 95°F), maximum 80% relative humidity, non-condensing.

Applications:

Cell cultures, DNA, RNA, and protein studies.

Ordering Information

Unit includes a detachable, 3-wire cord and plug . Unit is also supplied with a 1.5 mL block, clear rack, and cover.

Model	Temperature Range	Temperature Accuracy	Speed Range	Speed Accuracy	Timer	Orbit	Cooling Rate	Heating Rate	Item No.	Price USD
ISTHBLHTS	4°C above ambient to 100°C	± 1°C between 20°C and 45°C ± 2°C above 45°C	300 to 3000 rpm	± 2%	1 minute to 99 hours, 59 minutes	3 mm (0.12")	above ambient 2-3°C/min	5°C/min	30392003	3100
ISTHBLCTS	17°C below ambient to 100°C	± 0.5°C between 20°C and 45°C ± 2°C below 20°C and above 45°C					below ambient 0.5-1.0°C/min		30391996	3900

Incubating Cooling Thermal Shakers Modular Blocks



Microplate Block

Sample Type	Well Size	Well Depth	Dimensions (L x W x H)	Item No.	Price USD
Microplate Thermal Block with Lid	4.21 x 2.81 x 0.1" (10.7 x 7.1 x 0.25 cm)	0.9" (2.30 cm)	4.7 x 6.4 x 3.0" (11.9 x 16.3 x 7.6 cm)	30400126	1010

Sample Type	Well Diameter	Well Depth	Dimensions (L x W x H)	Item No.	Price USD
384 Well Plate Thermal Block with Lid	0.16" (0.40 cm)	0.32" (0.81 cm)	4.7 x 6.4 x 3.0" (11.9 x 16.3 x 7.6 cm)	30400127	1010
0.2 mL PCR Plate Thermal Block with Lid	0.25" (0.64 cm)	0.50" (1.27 cm)	4.7 x 6.4 x 3.0" (11.9 x 16.3 x 7.6 cm)	30400128	1010

Tube Blocks

Sample Type	No. of Wells	Well Diameter	Well Depth	Dimensions (L x W x H)	Item No.	Price USD
0.5 mL Microtubes*	30	0.31" (0.79 cm)	0.97" (2.46 cm)	4.0 x 5.6 x 1.8" (10.2 x 14.2 x 4.6 cm)	30400129	765
1.5 mL Microtubes*	24	0.44" (1.11 cm)	1.39" (3.53 cm)	4.0 x 5.6 x 2.1" (10.2 x 14.2 x 5.3 cm)	30400130	765
2.0 mL Microtubes*	24	0.45" (1.15 cm)	1.39" (3.53 cm)	4.0 x 5.6 x 2.1" (10.2 x 14.2 x 5.3 cm)	30400131	765
12 mm Tubes	24	0.47" (1.20 cm)	1.42" (3.61 cm)	4.0 x 5.6 x 2.2" (10.2 x 14.2 x 5.6 cm)	30400132	765

* Supplied with clear rack and cover

Racks and Covers

Description	Item No.	Price USD
Rack For 30 X 0.5 mL Tube Block	30400250	38
Rack For 24X1.5 / 24X2.0 mL Tube Blocks	30400251	38
Cover For 0.5mL/1.5mL/2.0mL Tube Blocks	30400252	26

Cryotube Block

Sample Type	No. of Wells	Well Diameter	Well Depth	Dimensions (L x W x H)	Item No.	Price USD
2.0 mL Cryotubes	24	0.50" (1.26 cm)	1.42" (3.6 cm)	4.0 x 5.6 x 2.2" (10.2 x 14.2 x 5.6 cm)	30400133	765

Conical Tube Blocks

Sample Type	No. of Wells	Well Diameter	Well Depth	Dimensions (L x W x H)	Item No.	Price USD
5 mL Eppendorf Tube Block	9	0.66" (1.68 cm)	1.93" (4.9 cm)	4.1 x 5.7 x 2.8" (10.4 x 14.5 x 7.1 cm)	30400134	765
15 mL Conical Tubes	9	0.68" (1.73 cm)	4.11" (10.44 cm)	4.2 x 5.7 x 5.0" (10.7 x 14.7 x 12.7 cm)	30400135	765
50 mL Conical Tubes	4	1.18" (3.0 cm)	3.97" (10.09 cm)	4.0 x 5.7 x 4.8" (10.2 x 14.5 x 12.2 cm)	30400136	765

Incubating Light Duty Orbital Shakers

- LED displays for temperature, speed and time
- Timer with audible alarm
- Calibration mode for temperature

The OHAUS Incubating Light Duty Orbital Shakers are designed to heat and shake a variety of samples.

Operating Features:

Microprocessor Control: The variable speed microprocessor control provides consistent uniform shaking action. Microprocessor will display last set-point and will restart if power is interrupted.

PID Temperature Controller: Maintains precise temperature control from ambient +5°C to 65°C. Easy-to-use controls allow users to adjust temperature in 1°C increments.

Triple Eccentric Drive: Permanently lubricated ball bearings and maintenance free, brushless DC motor provide reliable service and continuous duty operation.

LED Display: Touchpad controls with easy-to-read, independent LED displays for temperature, speed and time allow operator to view all settings at once. Provides repeatable and accurate results every time and is easily visible across lab benches. Timer will display elapsed time or, when programmed to user defined limit, will shut off unit when time reaches zero. Display will show last used settings, even after power has been turned off.

Temperature Calibration Mode: Allows user to calibrate unit to an external temperature device.

Safety Features:

Overload Protection: Audible and visual signals will activate when system detects an obstruction or overload of the tray.

Speed Ramping Feature: Slowly increases speed to desired set-point to avoid splashing.

Audible Alarm: In timed mode, alarm will sound when the time reaches zero.

Caution Hot Indicator: Symbol illuminates when the temperature of the air in the chamber reaches 40°C and remains lit until temperature cools down.

Spill-Resistant Design: Channels fluids away from internal components.

Polycarbonate Lid: Permits viewing of samples without disturbing internal temperature.

Operating Conditions:

Unit can be run in conditions from 5 to 40°C (41 to 104°F), maximum 80% relative humidity, non-condensing.

Applications:

Cell cultures, bacterial suspensions, and hybridizations.

Ordering Information:

Unit includes a detachable, 3-wire cord and plug.



Model	Temp. Range	Temp. Uniformity	Speed Range	Speed Accuracy	Timer	Orbit	Maximum Weight Capacity	Tray Dimensions (L x W)	Interior Dimensions (L x W x H)	Item No.	Price USD
ISLD04HDG	Ambient +5°C to 65°C	± 0.5°C at 37°C	100 to 1200 rpm	± 2% of set speed	1 second to 160 hours	3 mm (0.12")	8 lbs (3.6 kg)	11 x 7.75" (27.9 x 19.7 cm)	11.3 x 8.3 x 5.7" (28.7 x 21.1 x 14.5 cm)	30391924	3830

Incubating Light Duty Orbital Shakers



- LED displays for temperature, speed and time
- Timer with audible alarm
- Available with opaque lid for light sensitive samples

The OHAUS Incubating Microplate Shakers are optimized for shaking microplates, deep-well plates, or micro-tubes.

Operating Features:

Microprocessor Control: The variable speed microprocessor control provides consistent uniform shaking action. Microprocessor will display last set-point and will restart if power is interrupted.

PID Temperature Controller: Maintains precise temperature control from ambient +5°C to 65°C. Easy-to-use controls allow users to adjust temperature in 1°C increments.

Triple Eccentric Drive: Permanently lubricated ball bearings and maintenance free, brushless DC motor provide reliable service and continuous duty operation.

LED Display: Touchpad controls with easy-to-read, independent LED displays for temperature, speed, and time allow operator to view all settings at once. Provides repeatable and accurate results every time and is easily visible across lab benches. Timer will display elapsed time or, when programmed to user defined limit, will shut off unit when time reaches zero. Display will show last used settings, even after power has been turned off.

Temperature Calibration Mode: Allows user to calibrate unit to an external temperature device.

Safety Features:

Overload Protection: Audible and visual signals will activate when system detects an obstruction or overload of the tray.

Speed Ramping Feature: Slowly increases speed to desired set-point to avoid splashing.

Audible Alarm: In timed mode, alarm will sound when the time reaches zero.

Caution Hot Indicator: Symbol illuminates when the temperature of the air in the chamber reaches 40°C and remains lit until temperature cools down.

Spill-Resistant Design: Channels fluids away from internal components.

Polycarbonate Lid: Clear lid permits viewing of samples without disturbing internal temperature. Opaque lid prohibits light exposure to light sensitive samples.

Operating Conditions:

Unit can be run in conditions from 5 to 40°C (41 to 104°F), maximum 80% relative humidity, non-condensing.

Applications:

Immunoassays and hybridizations.

Ordering Information:

Units include a detachable, 3-wire cord and plug.



Model	Temp. Range	Temp. Uniformity	Speed Range	Speed Accuracy	Timer	Orbit	Maximum Weight Capacity	Tray Dimensions (L x W)	Item No.	Price USD
ISLDMPHDG	Ambient +5°C to 65°C	± 0.5°C at 37°C	100 to 1200 rpm	± 2%	1 second to 160 hours	3 mm (0.12")	4 micro-plates or 2 micro-tube racks	11 x 7.75" (27.9 x 19.7 cm)	30391938	3416
ISLDMPHDGL*									30391931	3416

*Unit includes opaque lid

Incubating Cooling Orbital Shakers

- Heats to 65°C and cools to 10°C below ambient
- LED displays for temperature, speed and time
- Calibration mode for temperature

The OHAUS Incubating/Cooling Orbital Shaker is microplate ready without the need for any additional accessories. Optional modular blocks can accommodate micro-tubes, centrifuge tubes, vials, or culture tubes. Unit holds microplates or modular blocks with a 5" (12.7 cm) tall interior capacity. Ideal for analyses that require a stable, controlled temperature.



Operating Features:

Microprocessor Control: The variable speed microprocessor control provides consistent uniform shaking action. Microprocessor will display last set-point and will restart if power is interrupted.

PID Temperature Controller: Maintains precise temperature control from 10°C below ambient to 65°C. Easy-to-use controls allow users to adjust temperature in 1°C increments.

Triple Eccentric Drive: Permanently lubricated ball bearings and maintenance free, brushless DC motor provide reliable service and continuous duty operation.

LED Display: Touchpad controls with easy-to-read, independent LED displays for temperature, speed, and time allow operator to view all settings at once. Provides repeatable and accurate results every time and is easily visible across lab benches. Timer will display elapsed time or, when programmed to user defined limit, will shut off unit when time reaches zero. Display will show last used settings, even after power has been turned off.

Temperature Calibration Mode: Allows user to calibrate unit to an external temperature device.

Safety Features:

Overload Protection: Audible and visual signals will activate when system detects an obstruction or overload of the tray.

Speed Ramping Feature: Slowly increases speed to desired set-point to avoid splashing.

Audible Alarm: In timed mode, alarm will sound when the time reaches zero. Alarm has optional mute function which can be set from the Touchpad control.

Caution Hot Indicator: Symbol illuminates when the temperature of the air in the chamber reaches 40°C and remains lit until temperature cools down.

Spill-Resistant Design: Channels fluids away from internal components.

Polycarbonate Lid: Permits viewing of samples without disturbing internal temperature.

Operating Conditions:

Unit can be run in conditions from 5 to 40°C (41 to 104°F), maximum 80% relative humidity, non-condensing.

Applications:

Cell and bacterial cultures, hybridizations, and enzyme reactions.

Ordering Information:

Unit includes a detachable, 3-wire cord and plug. Units are also supplied with an adapter bracket to hold optional modular blocks. See page 137 - 138 for block options.

Model	Temp. Range	Temp. Uniformity	Speed Range using Microplates	Speed Range using Modular Blocks	Speed Accuracy	Timer	Orbit	Maximum Weight Capacity	Item No.	Price USD
ISICMBCDG	10°C below ambient to 65°C	± 0.5°C at 37°C	100 to 1200 rpm	100 to 600 rpm	± 2%	1 second to 160 hours	3 mm (0.12")	2 micro-plates or 2 modular blocks	30391945	4716

Incubating Light Duty Orbital Shakers Modular Blocks



Modular Blocks

Modular Blocks are constructed from a solid anodized aluminum block. The close contact of tubes to block walls allow for maximum temperature transfer.

Block dimensions (L × W × H): 3.75 × 3 × 2" (9.5 × 7.6 × 5.1 cm)

Applications: Cell cultures, hybridizations, and extraction procedures

OHAUS modular blocks also fit in the OHAUS Dry Block Heaters.

Constructed of anodized aluminum, this material is ideal for its temperature conducting and corrosion resistant properties.

Microcentrifuge Tube Blocks

Single block

Sample Type	No. of Wells	Well Diameter	Well Depth	Item No.	Price USD
0.5 mL tube	30	7.9 mm	27.6 mm	30400157	136
1.5 mL tube	20	11.1 mm	39.1 mm	30400159	136
2 mL tube	20	11.5 mm	38.1 mm	30400191	136



Conical-Bottom Centrifuge Tube Blocks

Single block

Sample Type	No. of Wells	Well Diameter	Well Depth	Item No.	Price USD
15 mL tube	12	17.1 mm	44.5 mm	30400172	136
50 mL tube	5	29.0 mm	47.6 mm	30400168	136



Incubating Light Duty Orbital Shakers Modular Blocks

Standard Test Tube Blocks

Single block

Sample Type	No. of Wells	Well Diameter	Well Depth	Item No.	Price USD
6 mm tube	30	8.3 mm	48.4 mm	30400158	136
10 mm tube	24	10.7 mm	48.4 mm	30400151	136
12/13 mm tube	20	13.9 mm	48.4 mm	30400152	136



Centrifuge Tube Combination Block

Single block

These blocks have been designed for variable sized samples.

Sample Type	No. of Wells	Well Diameter	Well Depth	Item No.	Price USD
Test Tube Combination					
6 mm	6	8.3 mm	48.4 mm	30400156	136
12/13 mm	5	13.8 mm	48.4 mm		
25 mm	3	26.2 mm	48.4 mm		
Centrifuge Tube Combination					
1.5 mL	4	11.1 mm	39.1 mm	30400193	136
15 mL	3	17.1 mm	44.5 mm		
50 mL	2	29.0 mm	47.6 mm		
Micro-Tube Combination					
0.5 mL	6	7.9 mm	27.6 mm	30400194	136
1.5 mL	10	11.1 mm	39.1 mm		
2 mL	5	11.5 mm	38.1 mm		



Vial Blocks

Single block

Designed for sample/serum and scintillation vials.

Sample Type	No. of Wells	Well Diameter	Well Depth	Item No.	Price USD
12 mm vial	20	12.7 mm	30 mm	30400182	136
15 mm vial	20	15.8 mm	35 mm	30400183	136
16 mm vial	15	16.4 mm	45 mm	30400190	136
17 mm vial	12	17.8 mm	45 mm	30400184	136
19 mm vial	12	19.7 mm	45 mm	30400185	136
21 mm vial	9	21.7 mm	45 mm	30400186	136
23 mm vial	8	23.8 mm	45 mm	30400187	136
25 mm vial	8	25.8 mm	45 mm	30400188	136
28 mm vial	6	28.8 mm	45 mm	30400189	136



Incubating Rocking & Waving Shakers

- Electronic tilt adjustment from 0 to 15° while unit is operating
- LED displays for temperature, speed and tilt angle, and time
- Timer with audible alarm

The OHAUS Incubating Rocking Shaker combines smooth rocking motion and general purpose incubation in one compact bench top unit.

Operating Features:

Microprocessor Control: The microprocessor control provides electronic tilt angle adjustment which allows user to easily adjust rocking angle from 0 to 15° while unit is operating. Precise speed control provides smooth, low-speed rocking motion down to 1 rpm.

PID Temperature Controller: Maintains precise temperature control from ambient +5°C to 65°C. Easy-to-use controls allow users to adjust temperature in 1°C increments.

LED Display: Touchpad controls with easy-to-read, independent LED displays for temperature, speed and tilt angle, and time allow operator to view all settings at once. Provides repeatable and accurate results every time and is easily visible across lab benches. Timer will display elapsed time or, when programmed to user defined limit, will shut off unit when time reaches zero. Display will show last used settings, even after power has been turned off.

Safety Features:

Overload Protection: Audible and visual signals will activate when system detects an obstruction or overload of the tray.

Speed Ramping Feature: Slowly increases speed to desired set-point to avoid splashing.

Audible Alarm: In timed mode, alarm will sound when the time reaches zero.

Caution Hot Indicator: Symbol illuminates when the temperature of the air in the chamber reaches 40°C and remains lit until temperature cools down.

Spill-Resistant Design: Channels fluids away from internal components.

Polycarbonate Lid: Permits viewing of samples without disturbing internal temperature.

Operating Conditions:

Unit can be run in conditions from 5 to 40°C (41 to 104°F), maximum 80% relative humidity, non-condensing.

Applications:

Cell cultures, staining and destaining gels, hybridization procedures, and blotting techniques.

Ordering Information:

Unit includes a detachable, 3-wire cord and plug.



Model	Temp. Range	Temp. Uniformity	Speed Range	Speed Accuracy	Tilt Angle	Timer	Maximum Weight Capacity	Tray Dimensions (L x W)	Interior Dimensions (L x W x H)	Item No.	Price USD
ISRK04HDG	Ambient +5°C to 65°C	± 0.5°C at 37°C	1 to 50 rpm *	± 1 rpm	0 to 15° *	1 second to 160 hours	10 lbs (4.5 kg) **	10 x 7.5" (25.4 x 19.1 cm)	10.75 x 7.75 x 3.8" (27.3 x 19.7 x 9.7 cm)	30391980	2976

* Maximum speed/tilt angle may vary with heavy or unbalanced loads.

** Centered on tray.

Incubating Rocking & Waving Shakers

- Electronic tilt adjustment from 0 to 20° while unit is operating
- LED displays for temperature, speed and tilt angle, and time
- Timer with audible alarm

The OHAUS Incubating Waving Shaker combines the unique vertical and horizontal “wave” motion with general purpose incubation in one compact bench top unit.

Operating Features:

Microprocessor Control: The microprocessor control provides electronic tilt angle adjustment which allows user to easily adjust waving angle from 0 to 20° while unit is operating. Precise speed control provides smooth, low-speed waving motion down to 1 rpm.

PID Temperature Controller: Maintains precise temperature control from ambient +5°C to 65°C. Easy-to-use controls allow users to adjust temperature in 1°C increments..

LED Display: Touchpad controls with easy-to-read, independent LED displays for temperature, speed and tilt angle, and time allow operator to view all settings at once. Provides repeatable and accurate results every time and is easily visible across lab benches. Timer will display elapsed time or, when programmed to user defined limit, will shut off unit when time reaches zero. Display will show last used settings, even after power has been turned off.

Safety Features:

Overload Protection: Audible and visual signals will activate when system detects an obstruction or overload of the tray.

Speed Ramping Feature: Slowly increases speed to desired set-point to avoid splashing.

Audible Alarm: In timed mode, alarm will sound when the time reaches zero.

Caution Hot Indicator: Symbol illuminates when the temperature of the air in the chamber reaches 40°C and remains lit until temperature cools down.

Spill-Resistant Design: Channels fluids away from internal components.

Polycarbonate Lid: Permits viewing of samples without disturbing internal temperature.

Operating Conditions:

Unit can be run in conditions from 5 to 40°C (41 to 104°F), maximum 80% relative humidity, non-condensing.

Applications:

Cell cultures, hybridization procedures, and blotting techniques.

Ordering Information:

Unit includes a detachable, 3-wire cord and plug.

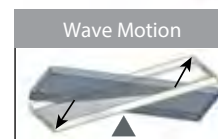

Model	Temp. Range	Temp. Uniformity	Speed Range	Speed Accuracy	Tilt Angle	Timer	Maximum Weight Capacity	Tray Dimensions (L x W)	Interior Dimensions (L x W x H)	Item No.	Price USD
ISWV02HDG	Ambient +5°C to 65°C	± 0.5°C at 37°C	1 to 30 rpm *	± 1 rpm	0 to 20° *	1 second to 160 hours	5 lbs (2.3 kg) **	9.25 x 7.25" (23.5 x 18.4 cm)	10.75 x 7.75 x 3.4" (27.3 x 19.7 x 8.6 cm)	30391987	2914

* Maximum speed/tilt angle may vary with heavy or unbalanced loads.

** Centered on tray.

Open Air , Incubating , Incubating Cooling Shakers Accessories

Universal Platforms

Allows for mounting of flask clamps, test tube racks, and bottle clamps. Platform slides over top of included tray and is tightened with adjustment screws. Optional accessories screw directly into mounting point openings. The two-tier braces allow stacking of platforms with a 10" clearance (available for select sizes). An optional non-skid rubber mat can be placed on the platform for an added non-slip surface. The platform is constructed of type 304 stainless steel.



Description	Used on Shakers	Item No.	Price USD
11 × 13" (27.9 × 33 cm) Universal Platform	Analog/Digital 16 kg Shakers and Reciprocating Shakers	30400052	198
13 × 13" (33 × 33 cm) Universal Platform	Analog/Digital 16 kg Shakers and Reciprocating Shakers	30400053	282
18 × 18" (45.7 × 45.7 cm) Universal Platform*	Analog/Digital 16 kg Shakers and Reciprocating Shakers**	30400054	338
18 × 24" (45.7 × 61 cm) Universal Platform*	Analog/Digital 16 kg & 23 kg Shakers and Reciprocating Shakers**	30400056	381
24 × 24" (61 × 61 cm) Universal Platform	Digital 45 kg Shakers	30400057	902
18 × 30" (45.7 × 76.2 cm) Universal Platform*	Analog/Digital 23 kg Shakers	30400058	865
24 × 36" (61 × 91.4 cm) Universal Platform	Digital 68 kg Shakers	30400059	1151
Two-Tier Braces (set of 4)	Analog/Digital 16 kg & 23 kg Shakers	30400051	107

Rubber Mats

Description	Used on Shakers	Item No.	Price USD
11 × 13" (27.9 × 33 cm) Rubber Mat	Analog/Digital 16 kg Shakers and Reciprocating Shakers	30400060	56
13 × 13" (33 × 33 cm) Rubber Mat	Analog/Digital 16 kg Shakers and Reciprocating Shakers	30400061	68
18 × 18" (45.7 × 45.7 cm) Rubber Mat	Analog/Digital 16 kg Shakers and Reciprocating Shakers	30400062	97
18 × 24" (45.7 × 61 cm) Rubber Mat	Analog/Digital 16 kg Shakers, Reciprocating Shakers and Analog Digital 23kg Shakers	30400063	108
24 × 24" (61 × 61 cm) Rubber Mat	Digital 45 kg Shakers	30400064	127
24 × 36" (61 × 91.4 cm) Rubber Mat	Digital 68 kg Shakers	30400065	141

Culture Platforms

Ideal for slow speed applications; Petri dishes, culture flasks, and other flat bottom, low profile vessels. The two-tier braces (available for both sizes) allow stacking of platforms with a 10" clearance. The platform is constructed of type 304 stainless steel. The platform has a non-skid rubber surface.



Description	Used on Shakers	Item No.	Price USD
18 × 18" (45.7 × 45.7 cm) Culture Platform*	Analog/ Digital 16 kg Shakers* and Reciprocating Shakers**	30400066	337
18 × 24" (45.7 × 61 cm) Culture Platform*	Analog/ Digital 16 kg* & 23 kg Shakers and Reciprocating Shakers**	30400067	352
Two-Tier Braces (set of 4)	Analog/ Digital 16 kg & 23 kg shakers	30400051	107

*Two-tier ready

**Stacking of platforms is not recommended for Reciprocating Shaker

Open Air , Incubating , Incubating Cooling Shakers Accessories

Dedicated Platforms

Pre-mounted flask clamps for maximum utilization of platform space for flasks of all one size. The two-tier braces allow stacking of platforms with a clearance (available for select sizes). Platform is constructed of type 304 stainless steel. Flask clamps are constructed of PVC. Ideal for polycarbonate flasks.



Description	Flask Capacity	Used on Shakers	Item No.	Price USD
13 × 13" (33 × 33 cm) Dedicated Platform / 125 mL Flask Clamp	16	Analog/Digital 16 kg Shakers and Reciprocating Shakers	30400075	528
13 × 13" (33 × 33 cm) Dedicated Platform / 250 mL Flask Clamp	12	Analog/Digital 16 kg Shakers and Reciprocating Shakers	30400076	528
13 × 13" (33 × 33 cm) Dedicated Platform / 500 mL Flask Clamp	8	Analog/Digital 16 kg Shakers and Reciprocating Shakers	30400077	528
13 × 13" (33 × 33 cm) Dedicated Platform / 1 L Flask Clamp	4	Analog/Digital 16 kg Shakers and Reciprocating Shakers	30400078	528
18 × 18" (45.7 × 45.7 cm) Dedicated Platform / 125 mL Flask Clamp*	27	Analog/Digital 16 kg Shakers and Reciprocating Shakers**	30400079	585
18 × 18" (45.7 × 45.7 cm) Dedicated Platform / 250 mL Flask Clamp*	20	Analog/Digital 16 kg Shakers and Reciprocating Shakers**	30400080	585
18 × 18" (45.7 × 45.7 cm) Dedicated Platform / 500 mL Flask Clamp*	13	Analog/Digital 16 kg Shakers and Reciprocating Shakers**	30400081	585
18 × 18" (45.7 × 45.7 cm) Dedicated Platform / 1 L Flask Clamp	9	Analog/Digital 16 kg Shakers and Reciprocating Shakers	30400082	585
Two-Tier Braces (set of 4)		Analog/Digital 16 kg Shakers	30400051	585

Adjustable Platforms

Adjustable clamping bars accommodate various vessel types. Constructed of stainless steel. The base tray has a non-skid rubber surface.

Upper slot distance – 4.5" from platform

Lower slot distance – 2 ¼" from platform

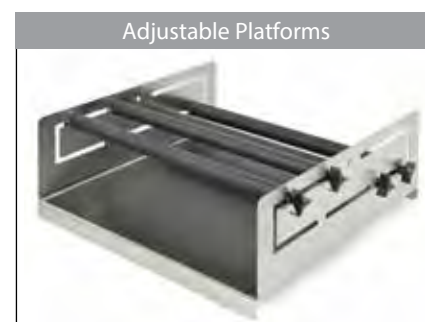

Description	Bar Size	Overall Dimensions	Used on Shakers	Item No.	Price USD
2-bar Adjustable Platform	8.6" (21.8 cm)	8.6 × 11.7" (21.8 × 29.7 cm)	Digital 4 kg Shakers	30400121	481
4-bar Adjustable Platform	18" (45.7 cm)	18 × 18" (45.7 × 45.7 cm)	Analog/Digital 16 kg Shakers	30400068	512
4-bar Adjustable Platform	18" (45.7 cm)	18 × 24" (45.7 × 61 cm)	Analog/Digital 23 kg Shakers	30400069	734

Replacement Parts

Description	Used with Platforms	Item No.	Price USD
8.6" (21.8 cm) Adjustable Bar (with Mounting Hardware)	30400121	30400122	43
18" (45.7 cm) Adjustable Bar (with Mounting Hardware)	30400068 & 30400069	30400073	58

*Two-tier ready

**Stacking of platforms is not recommended for Reciprocating Shaker

Open Air , Incubating , Incubating Cooling Shakers Accessories

Large Vessel Carrier Platforms

Ideal for large sample containers like carboys, jugs and bottles. The platform's high side walls secure samples, has a heavy-duty design and is constructed of stainless steel. The base tray has a non-skid rubber surface.



Description	Bar Size	Overall Dimensions (L x W x H)	Used on Shakers	Item No.	Price USD
4-bar Large Vessel Carrier Platform	18" (45.7 cm)	30.1 x 18.1 x 13.9" (76.4 x 45.9 x 35.3 cm)	Analog/Digital 23 kg Shakers	30400070	1227
4-bar Large Vessel Carrier Platform	24" (61 cm)	24.4 x 24.3 x 14.2" (61.9 x 61.7 x 36.0 cm)	Digital 45 kg Shakers	30400071	1284
5-bar Large Vessel Carrier Platform	24" (61 cm)	36.9 x 24.3 x 14.2" (93.7 x 61.7 x 36.0 cm)	Digital 68 kg Shakers	30400072	1645

Replacement Part	Used with Carrier	Item No.	Price USD
18" (45.7 cm) Adjustable Bar (with Mounting Hardware)	30400070	30400073	58
24" (61 cm) Adjustable Bar (with Mounting Hardware)	30400071 & 30400072	30400074	72

Separatory Funnel Platform

Holds 3 funnels at once on an 18 x 18" (45.7 x 45.7 cm) platform. Platform can accommodate 500 mL to 2 L separatory funnels and is constructed of stainless steel. Includes platform, clamps and hardware to secure 3 funnels.



Description	Used on Shakers	Item No.	Price USD
Separatory Funnel Platform 46 X 46 cm	Analog/Digital 16 kg Shakers and Reciprocating Shakers	30400083	563

Microplate Clamp

Can hold one standard microplate or deep-well plate. Constructed of type 304 stainless steel.



Platform Capacities for Microplate Clamps			
Platform Size	Microplate Clamps	Platform Item No.	Price USD
11 x 13	4	30400052	198
13 x 13	6	30400053	282
18 x 18	12	30400054	338
18 x 24	18	30400056	381
18 x 30	21	30400057	902
24 x 24	24	30400058	865
24 x 36	36	30400059	1151

Description	Used on Shakers	Item No.	Price USD
Microplate Clamp	Analog/Digital 16 kg, 23 kg, 45 kg, & 68 kg Shakers	30400104	57

Open Air , Incubating , Incubating Cooling Shakers Accessories

Universal Harness

Attaches to tray to secure low-profile plates.

Description	Used on Shakers	Item No.	Price USD
Universal Harness	Digital 4 kg Open Air Orbital Shakers	30400123	38



Dimpled Mat

Designed to hold centrifuge tubes, vials, culture tubes, and micro-tubes securely in place. Mat can easily be removed for cleaning and transporting of tubes from bench to tray.

Description	Used on Shakers	Item No.	Price USD
Dimpled Mat, 12.75 × 10" (32.4 × 25.4 cm)	Digital Rocking Shaker	30400140	52
Dimpled Mat, 11.75 × 8.75" (29.9 × 22.2 cm)	Digital Waving Shaker	30400142	52
Dimpled Mat, 10 × 7.5" (25.4 × 19.1 cm)	Incubating Rocking Shaker	30400141	52
Dimpled Mat, 9.25 × 7.25" (23.5 × 18.4 cm)	Incubating Waving Shaker	30400143	52
Dimpled Mat, 11.75 × 8.75" (29.9 × 22.2 cm)	Open Air 4 kg Orbital Shaker	30400124	49
Dimpled Mat, 14 × 11" (35.6 × 27.9 cm)	Analog Rocking & Waving Shaker	30400144	60



Stacking Tray

Easily attaches to the units' included tray to add a second tier for higher capacity applications. Second tier tray mounts 3.5" (8.9 cm) above lower tray. The tray includes hardware and a rubber mat.

Description	Used on Shakers	Item No.	Price USD
Stacking Tray, 12.75 × 10" (32.4 × 25.4 cm)	Digital Rocking Shaker	30400137	126
Stacking Tray, 11.75 × 8.75" (29.9 × 22.2 cm)	Digital Waving Shaker	30400138	154
Stacking Tray, 14 × 11" (35.6 × 27.9 cm)	Analog Rocking Shaker	30400139	112



Dilution Cup Tray

Constructed of type 304 stainless steel. Holds 24 × 28 mm dilution vials.

Description	Used on Unit	Item No.	Price USD
1.5 to 2 mL Micro-Tube Rack	Digital 4 kg Open Air Orbital Shakers	30400125	216



Micro-Tube Rack

Optional 1.5 to 2 mL Micro-Tube Rack attaches to tray to hold up to 70 × 1.5 mL or 2 mL micro-tubes. Tray can accommodate up to 2 micro-tube racks.

Description	Used on Unit	Item No.	Price USD
Stacking Tray, 12.75 × 10" (32.4 × 25.4 cm)	Digital Open Air and Incubating Microplate Shaker	30400114	152



Open Air , Incubating , Incubating Cooling Shakers Accessories

Stainless Steel Flask Clamps

Designed to hold Erlenmeyer flasks from 10 mL to 6 L. Constructed of type 302 and 304 stainless steel. Includes hardware for easy attachment to platforms. Flask clamps 50 mL and higher are supplied with a spring to hold the flask in place. The 2.8 L clamp is designed to hold a Fernbach flask. Media bottle clamps feature the same details as flask clamps.

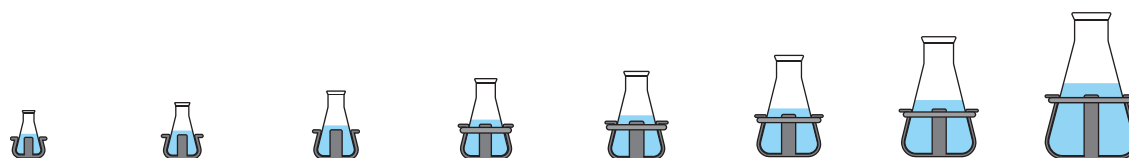

Clamp Style	10 mL Erlenmeyer Flask Clamp	25 mL Erlenmeyer Flask Clamp	50 mL Erlenmeyer Flask Clamp	125 mL Erlenmeyer Flask Clamp	250 mL Erlenmeyer Flask Clamp	500 mL Erlenmeyer Flask Clamp	1 L Erlenmeyer Flask Clamp	2 L Erlenmeyer Flask Clamp
Material	Stainless Steel	Stainless Steel	Stainless Steel	Stainless Steel	Stainless Steel	Stainless Steel	Stainless Steel	Stainless Steel
Item No.	30400084	30400085	30400086	30400087	30400088	30400089	30400090	30400091
Tray or Platform	Number of Flask Clamps per Tray or Platform							
11.75 × 8.75" (29.9 × 22.2 cm) Open Air Digital 4 kg Shakers	35	20	15	12	6	4	N/A	N/A
11 × 7.75" (27.9 × 19.7 cm) Incubating 4 kg Shakers	35	20	12	8	5	N/A	N/A	N/A
11 × 13" (27.9 × 33 cm) Analog/Digital 16 kg Shakers	60	25	13	10	9	7	4	N/A
Digital Reciprocating Shakers	60	25	13	10	9	7	4	N/A
13 × 13" (33 × 33 cm) Analog/Digital 16 kg Shakers	60	30	15	12	12	8	4	3
Digital Reciprocating Shakers	60	30	15	12	12	8	4	3
18 × 18" (45.7 × 45.7 cm) Analog/Digital 16 kg Shakers	113	64	32	20	20	13	8	5
Digital Reciprocating Shakers	113	64	32	20	20	13	8	5
18 × 24" (45.7 × 61 cm) Analog/Digital 16 kg Shakers	158	88	44	28	28	20	12	6
Digital Reciprocating Shakers	158	88	44	28	28	20	12	6
Analog/Digital 23 kg Shakers	158	88	44	28	28	20	12	6
18 × 30" (45.7 × 76.2 cm) Analog/Digital 23 kg Shakers	203	112	56	36	36	26	15	8
24 × 24" (61 × 61 cm) Digital 45 kg Shakers	221	121	61	41	41	25	16	9
24 × 36" (61 × 91.4 cm) Digital 63 kg Shakers	336	160	94	61	64	40	24	14
Price USD	34	34	36	36	36	39	53	84

*All units require a universal platform for mounting flask clamps *or test tube racks with the exception of the digital open air and incubating 4 kg shakers

Open Air , Incubating , Incubating Cooling Shakers Accessories

PVC Flask Clamps

Constructed of one piece, molded PVC. Autoclavable. Will not scratch or mark flask like other clamps. Includes hardware for easy attachment to universal platforms. The attachment and removal of flasks is quick and easy. Ideal for polycarbonate flasks.

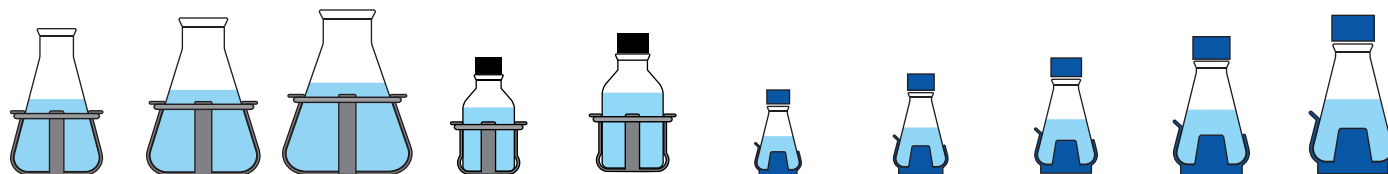

2.8 L & 3 L Fernbach Flask Clamp	4 L Erlenmeyer Flask Clamp	5 L & 6 L Erlenmeyer Flask Clamp	500 mL Media Bottle Clamp	1 L Media Bottle Clamp	125 mL Erlenmeyer Flask Clamp	250 mL Erlenmeyer Flask Clamp	500 mL Erlenmeyer Flask Clamp	1 L Erlenmeyer Flask Clamp	2 L Erlenmeyer Flask Clamp
Stainless Steel	Stainless Steel	Stainless Steel	Stainless Steel	Stainless Steel	PVC	PVC	PVC	PVC	PVC
2.8L-30400092 3L-30400093	30400094	5 L-30400095 6 L-30400096	30400097	30400098	30400099	30400100	30400101	30400102	30400103
Number of Flask Clamps per Tray or Platform									
N/A	N/A	N/A	3	N/A	12	6	4	N/A	N/A
N/A	N/A	N/A	N/A	N/A	8	4	N/A	N/A	N/A
N/A	N/A	N/A	5	2	10	8	5	2	N/A
N/A	N/A	N/A	5	2	10	8	5	2	N/A
1	1	1	6	5	12	10	6	4	3
1	1	1	6	5	12	10	6	4	3
2	4	2	16	10	20	18	12	8	4
2	4	2	16	10	20	18	12	8	4
3	4	3	20	13	28	25	16	10	6
3	4	3	20	13	28	25	16	10	6
3	4	3	20	13	28	25	16	10	6
3	6	4	28	18	36	33	20	14	8
5	5	5	25	18	41	35	24	13	9
7	9	7	40	30	61	55	38	22	13
112 151	139	169 165	104	113	38	39	45	50	85

Open Air , Incubating , Incubating Cooling Shakers Accessories

Test Tube Racks

Half Size, Stationary

Racks constructed of PVC coated steel. Includes hardware for easy attachment to platforms.

Dimensions:

5 L x 7 W x 4" H (12.7 x 17.8 x 10.2 cm) / Micro-Tube Rack: 1.7" H (4.3 cm).



Test Tube Style	1.5 to 2 mL Micro-Tube Rack Half Size, Stationary	10 to 13 mm Test Tube Rack Half Size, Stationary	14 to 16 mm Test Tube Rack Half Size, Stationary	18 to 20 mm Test Tube Rack Half Size, Stationary	22 to 25 mm Test Tube Rack Half Size, Stationary	15 mL Centrifuge Tube Rack Half Size, Stationary	50 mL Centrifuge Tube Rack Half Size, Stationary
Tube Capacity	70	63	48	35	24	35	12
Item No.	30400114	30400115	30400116	30400117	30400118	30400119	30400120
Tray or Platform	Number of Test Tube Racks per Tray or Platform						
11.75 x 8.75" (29.9 x 22.2 cm) Digital Open Air 4 kg Shakers	2	2	2	2	2	2	2
11 x 7.75" (27.9 x 19.7 cm) Incubating 4 kg Shakers	2	1	1	N/A	N/A	1	1
Digital Open Air 4 kg Shakers	2	N/A	N/A	N/A	N/A	N/A	N/A
Incubating Microplate Shakers	2	N/A	N/A	N/A	N/A	N/A	N/A
11 x 13" (27.9 x 33 cm) Analog/Digital 16 kg Shakers	2	2	2	2	2	2	2
Digital Reciprocating Shakers	2	2	2	2	2	2	2
13 x 13" (33 cm x 33 cm) Analog/Digital 16 kg Shakers	2	2	2	2	2	2	2
Digital Reciprocating Shakers	2	2	2	2	2	2	2
18 x 18" (45.7 x 45.7 cm) Analog/Digital 16 kg Shaker	4	4	4	4	4	4	4
Digital Reciprocating Shakers	4	4	4	4	4	4	4
18 x 24" (45.7 x 61 cm) Analog/Digital 16 kg Shakers	6	6	6	6	6	6	6
Digital Reciprocating Shakers	6	6	6	6	6	6	6
Analog/Digital 23 kg Shakers	6	6	6	6	6	6	6
18 x 30" (45.7 x 76.2 cm) Analog/Digital 23 kg Shakers	8	8	8	8	8	8	8
24 x 24" (61 x 61 cm) Digital 45 kg Shakers	8	8	8	8	8	8	8
24 x 36" (61 x 91.4 cm) Digital 63 kg Shakers	7	7	7	7	7	7	7
Price USD	152	168	168	168	168	175	175

* All units require a universal platform for mounting flask clamps or test tube racks with the exception of the digital open air and incubating 4 kg shakers

Open Air , Incubating , Incubating Cooling Shakers

Accessories

Test Tube Racks

Full Size, Stationary

Racks constructed of PVC coated steel. Includes hardware for easy attachment to platforms.

Dimensions

3.75 L x 16.5 W x 4" H (9.5 x 41.9 x 10.2 cm)

Full Size, Pivoting

Has adjustable angle, custom tilt. Stainless steel holder includes removable plastic rack. Rack is easily removed to transport from work area to shaker.

Inside pivoting rack dimensions:

5.1 x 10.8 x 3.9" (12.9 x 27.4 x 9.9 cm)

Outside stationary rack dimensions:

5.0 x 10.9 x 5" (12.7 x 27.6 x 12.7 cm)

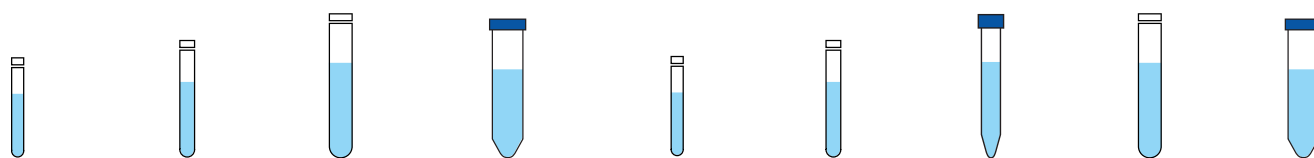

10 to 14 mm Test Tube Rack Full Size, Stationary	16 to 20 mm Test Tube Rack Full Size, Stationary	21 to 25 mm Test Tube Rack Full Size Stationary	50 mL Centrifuge Tube Rack Full Size, Stationary	13 mm Test Tube Rack Full Size, Pivoting	16 mm Test Tube Rack Full Size, Pivoting	20 mm Test Tube Rack Full Size, Pivoting	25 mm Tube Rack Full Size, Pivoting	30 mm Tube Rack Full Size, Pivoting
48	33	21	17	90	60	40	24	21
30400110	30400111	30400112	30400113	30400105	30400106	30400107	30400108	30400109
Number of Test Tube Racks per Tray or Platform								
N/A	N/A	N/A	N/A	N/A	N/A	N/A	N/A	N/A
N/A	N/A	N/A	N/A	N/A	N/A	N/A	N/A	N/A
N/A	N/A	N/A	N/A	N/A	N/A	N/A	N/A	N/A
N/A	N/A	N/A	N/A	1	1	1	1	1
N/A	N/A	N/A	N/A	1	1	1	1	1
N/A	N/A	N/A	N/A	2	2	2	2	2
N/A	N/A	N/A	N/A	2	2	2	2	2
N/A	N/A	N/A	N/A	2	2	2	2	2
N/A	N/A	N/A	N/A	2	2	2	2	2
5	5	5	5	3	3	3	3	3
5	5	5	5	3	3	3	3	3
5	5	5	5	3	3	3	3	3
6	6	6	6	4	4	4	4	4
7	7	7	7	4	4	4	4	4
5	5	5	5	6	6	6	6	6
332	332	332	348	296	296	296	296	296

Fixed Speed Vortex Mixers

- Sturdy design
- Fixed high speed mixing
- Touch mode operation

Built sturdy to provide stable and reliable vortexing action. Starts mixing when the cup head is pressed down. Speed is fixed at full rpm to provide vigorous vortexing of samples.

Operating Conditions:

Unit can be run in conditions from 4 to 40°C (39 to 104°F), 20% to 85% relative humidity, non-condensing.

Ordering Information:

Units include a 3-wire cord and plug. Includes both cup head and 3" head with cover.



Model	Speed Range 120V	Orbit	Controls	Duty Rating	Item No.	Price USD
VXMNFS	3200 rpm	4.9 mm (0.19")	None	Intermittent duty	30392108	333

Analog Mini Vortex Mixers

- Sturdy design
- Variable, analog speed control
- Continuous or touch mode operation

Built sturdy to provide stable and reliable vortexing action. Control allows low rpm startup for gentle shaking or high speed mixing for vigorous vortexing of samples. Two modes of operation; continuous mode when using accessory attachments or touch mode which activates mixing when depressing the cup head.

Operating Conditions:

Unit can be run in conditions from 4 to 40°C (39 to 104°F), 20% to 85% relative humidity, non-condensing.

Ordering Information:

Units include a 3-wire cord and plug. Includes both cup head and 3" head with cover. Additional accessories can be found on pages 151-152.



Model	Speed Range* 120V	Orbit	Controls	Duty Rating	Item No.	Price USD
VXMNAL	300 to 3200 rpm	4.9 mm (0.19")	Auto/Off/On Rocker Switch, Speed Knob: Variable 1 to 10 Dial Marks	Intermittent duty	30392115	377

* Maximum speed will vary depending on accessory used.

Digital Mini Vortex Mixers

- Sturdy design
- LED displays for speed and time
- Continuous or touch mode operation

Built sturdy to provide stable and reliable vortexing action. Ideal for applications that demand repeatable results. Microprocessor control maintains set speed for strong, consistent mixing action. Timer will display elapsed time or, when programmed to user defined time limit, the unit will shut off when time reaches zero. Two modes of operation; continuous mode when using accessory attachments or touch mode which activates mixing when depressing the cup head.

Operating Conditions:

Unit can be run in conditions from 4 to 40°C (39 to 104°F), 20% to 85% relative humidity, non-condensing.

Ordering Information:

Units include a 3-wire cord and plug. Includes both cup head and 3" head with cover. Additional accessories can be found on pages 151-152.



Model	Speed Range* 120V	Timer	Orbit	Controls	Duty Rating	Item No.	Price USD
VXMNDG	500 to 3000 rpm	1 second to 160 hours	4.9 mm (0.19")	Auto/Standby/On Rocker Switch, LED Displays for Speed/ Time, Up/Down Buttons for Set-Point Control	Intermittent duty	30392122	481

* Maximum speed will vary depending on accessory used.

Pulsing Mini Vortex Mixers

- Sturdy design
- LED displays for time and speed
- Glass bead cell disruption/homogenization

Built sturdy to provide stable and reliable vortexing action. Powerful pulsing vortex action produces excellent cell disruption for glass bead procedures. Capable of complete cell disruption of samples in only minutes. Unique pulsing action reduces heat generation while providing more effective mixing and disruption. Displayed time counts up during continuous operation and counts down during timed runs.

Operating Conditions:

Unit can be run in conditions from 4 to 40°C (39 to 104°F), 20% to 85% relative humidity, non-condensing.

Ordering Information:

Units include a 3-wire cord and plug. Includes cup head, 3" head with cover, and an easy-to-load 1.5 mL to 2 mL Micro-Tube Holder. Holder has a built-in cup head. Additional accessories can be found on pages 151-152.



Model	Speed Range* 120V	Timer	Orbit	Controls	Duty Rating	Item No.	Price USD
VXMNPS	500 to 3000 rpm	1 second to 160 hours	2.5 mm (0.098")	Auto/Standby/On Rocker Switch, LED Displays for Speed/ Time, Up/Down Buttons for Set-Point Control Pulse Button	Intermittent duty	30392129	611

* Maximum speed will vary depending on accessory used.

Mini Vortex Mixer Accessories

Micro-Tube Holder

Mixes (48) 0.25 to 2 mL micro-tubes.

Requires Insert Retainer.

Description	Item No.	Price USD
Micro-Tube Holder (2 pack)	30400232	65
Insert Retainer	30400227	127

9 to 13 mm Tube Holder

Ideal for mixing 5 mL culture tubes and micro-vials.

Requires Insert Retainer.

Description	Item No.	Price USD
9 to 13 mm Tube Holder (2 pack)	30400229	30
Insert Retainer	30400227	127

14 to 19 mm Tube Holder

Ideal for mixing up to (8) 15 mL centrifuge tubes.

Requires Insert Retainer.

Description	Item No.	Price USD
14 to 19 mm Tube Holder (2 pack)	30400230	30
Insert Retainer	30400227	127

20 to 25 mm Tube Holder

Ideal for mixing up to (8) 50 mL centrifuge tubes.

Requires Insert Retainer

Description	Item No.	Price USD
20 to 25 mm Tube Holder (2 pack)	30400231	30
Insert Retainer	30400227	127

Vessel Harness

Mixes Erlenmeyer flasks and media bottles.

Requires Insert Retainer.

Description	Item No.	Price USD
Vessel Harness (2 pack)	30400228	9
Insert Retainer	30400227	127

Cup Head

Designed for mixing 1 tube at a time.

Description	Item No.	Price USD
Cup Head	30400235	37

3" Rubber Head Cover and 3" Head

Designed for mixing irregular shaped objects.

Description	Item No.	Price USD
3" (7.6 cm) Rubber Head Cover	30400196	52
3" (7.6 cm) Head	30400236	37
3" (7.6 cm) Head with Rubber Cover	30400237	37

Microplate Holder

Ideal for mixing 96-well plates or deep well blocks.

Requires Insert Retainer.

Description	Item No.	Price USD
Microplate Holder (2 pack)	30400233	65
Insert Retainer	30400227	127

Flat Foam Insert

Ideal for custom applications. Can be cut or drilled to fit your specifications. Requires Insert Retainer.

Description	Item No.	Price USD
Flat Foam Insert (2 pack)	30400234	29
Insert Retainer	30400227	127

Microwell Kit with Retainer

Includes:

- 2 Microplate Holders
- 1 Insert Retainer

Description	Item No.	Price USD
Microwell Kit with Retainer	30400199	113

Microtube Kit with /Retainer

Includes:

- 2 Micro-Tube Holders
- 1 Insert Retainer

Description	Item No.	Price USD
Microtube Kit with /Retainer	30400200	113

Foam Insert Variety Pack

Includes:

- (1) 9 to 13 mm Tube Holder
- (1) 14 to 19 mm Tube Holder
- (1) 20 to 25 mm Tube Holder
- 1 Flat Foam Insert

Description	Item No.	Price USD
Foam Insert Variety Pack	30400201	57

Micro-Tube and Microplate Holder Kit

Includes:

- 1 Micro-Tube Holder
- 1 Microplate Holder
- 1 Insert Retainer

Description	Item No.	Price USD
Micro-Tube & Microplate Holder Kit	30400198	113

Tube Holder Kit

Includes:

- (1) 9 to 13 mm Tube Holder
- (1) 14 to 19 mm Tube Holder
- (1) 20 to 25 mm Tube Holder
- 1 Flat Foam Insert
- 2 Vessel Harnesses
- 1 Insert Retainer

Description	Item No.	Price USD
Tube Holder Kit	30400197	193

OHAUS Vortex Mixer accessories are interchangeable with other manufacturers' models. Call 1-800-672-7722 for assistance.

Mini Vortex Mixer Accessories

Single Tube Holder

Single tube, hands free mixing. Easily attaches to the top of any Vortex Mixer with the use of a strong magnetic base. Accepts tubes from 2.5 to 4.5" (6.4 to 11.4 cm) in length. Minimum tube diameter of 0.75" (19 mm).

Description	Item No.	Price USD
Single Tube Holder	30400202	165

Single Tube Holder Accessories

(Requires Single Tube Holder)

0.5 mL Micro-Tube Holder

Mixes (24) 0.5 mL micro-tubes.
For use with Single Tube Holder.

Description	Item No.	Price USD
Micro-Tube Holder (0.5 mL)	30400204	71

Ampule Tube Holder

Mixes up to 4 storage vials and test tubes.

Description	Item No.	Price USD
15 to 17 mm Ampule Tube Holder	30400207	121
10 to 17 mm Ampule Tube Holder	30400208	172

Stainless Steel Microtube Holder

Mixes up to (12) 1.5 to 5 mL tubes.
Stainless steel construction.

Description	Item No.	Price USD
Microtube Holder	30400206	263

Adapter for Vortex-Genie® Mixer*

Adapter plate easily adheres to the Vortex-Genie® Mixer housing so Single Tube Holder (sold separately) can be attached.

Description	Item No.	Price USD
Adapter plate	30400203	165

* The Vortex-Genie® Mixer is a registered trademark of Scientific Industries, Inc.

1.5 mL to 2.0 mL Micro-Tube Holder

Mixes (18) 1.5 to 2 mL micro-tubes.
For use with Single Tube Holder.

Description	Item No.	Price USD
Microtube Holder (1.5 mL to 2.0 mL)	30400205	71

Heavy-Duty Vortex Mixers

- Designed for continuous duty
- LED displays for speed and time
- Includes foam insert for 1.5 mL to 2.0 mL microtubes

The OHAUS Digital Heavy-Duty Vortex Mixer is ideal for applications that demand repeatable results. Mixer features touchpad controls and LED displays for accurate speed (rpm) and time (minutes and seconds) results. The heavy-duty design and efficient motor allow this mixer to operate in continuous duty and handle all accessories over the entire speed range. Choose from two modes of operation: "Touch" mode for mixing tubes when cup head or Universal Holder with cover is depressed, or "On" mode when using any of the accessory attachments for continuous operation. Microprocessor control maintains set speed for strong, consistent mixing action. Timer will display elapsed time or, when programmed to user defined time limits, the unit will shut off when time reaches zero.

Operating Features:

Microprocessor Control: The variable speed microprocessor control provides consistent uniform mixing action.

LED Display: Touchpad controls with easy-to-read, independent LED displays for speed and time allow operator to view both settings at once. Provides repeatable and accurate results every time and is easily visible across lab benches. Timer will display elapsed time or, when programmed to user defined limit, will shut off unit when time reaches zero. Display will show last used settings, even after power has been turned off.

Operating Conditions:

Unit can be run in conditions from 4 to 40°C (39 to 104°F), 20% to 85% relative humidity, non-condensing.

Ordering Information:

Mixer includes a cup head, universal holder with cover, foam microtube insert for (38) 1.5 to 2.0 mL microtubes, and a detachable, 3-wire cord and specified plug. Additional accessories can be found on page 157.



Model	Speed Range	Timer	Orbit	Controls	Capacity	Duty Rating	Dimensions (L x W x H)	Item No.	Price USD
VXHDDG	On Mode 300 to 2500 rpm Touch Mode 300 to 3500 rpm	1 second to 160 hours	4.9 mm (0.19")	Touch/Standby/On Rocker Switch, LED Displays for Speed/Time, Up/Down Buttons for Set-Point Control	2.5 lbs (1.1 kg)	Continuous duty	9.5 x 6.6 x 6.1" (24.1 x 16.8 x 16.5 cm)	30392146	1188

Heavy-Duty Vortex Mixers

- Designed for continuous duty
- Includes foam insert for 1.5 mL to 2.0 mL microtubes
- Heavy-duty design

The OHAUS Analog Heavy-Duty Vortex Mixer is a variable speed analog mixer that is designed for continuous duty. The heavy-duty design and efficient motor allow this mixer to operate in continuous duty and handle all accessories over the entire speed range. Choose from two modes of operation: "Touch" mode for mixing tubes when cup head or Universal Holder with cover is depressed, or "On" mode when using any of the accessory attachments for continuous operation.

Operating Conditions:

Unit can be run in conditions from 4 to 40°C (39 to 104°F), 20% to 85% relative humidity, non-condensing.

Ordering Information:

Mixer includes a cup head, universal holder with cover, foam microtube insert for (38) 1.5 to 2.0 mL microtubes, and a detachable, 3-wire cord and specified plug. Additional accessories can be found on page 157.



Model	Speed Range	Orbit	Controls	Capacity	Duty Rating	Dimensions (L x W x H)	Item No.	Price USD
VXHDAL	On Mode 300 to 2500 rpm Touch Mode 300 to 3500 rpm	4.9 mm (0.19")	Analog	2.5 lbs (1.1 kg)	Continuous duty	9.5 x 6.6 x 6.1" (24.1 x 16.8 x 16.5 cm)	30392148	959

Microplate Vortex Mixers

- Designed for continuous duty
- Designed for shaking microplates or tubes
- LED displays for speed and time

The OHAUS Digital Microplate Vortex Mixer is ideal for applications that demand repeatable results. Mixer features touchpad controls and LED displays for accurate speed (rpm) and time (minutes and seconds) results. Microprocessor control maintains set speed for strong, consistent mixing action. Timer will display elapsed time or, when programmed to a user defined time limit, the unit will shut off when time reaches zero. Choose from two modes of operation: "Touch" mode which activates mixing when cup head is depressed, or "On" mode when using the microplate attachments for continuous operation.

Operating Features:

Microprocessor Control: The variable speed microprocessor control provides consistent uniform mixing action.

LED Display: Touchpad controls with easy-to-read, independent LED displays for speed and time allow operator to view both settings at once. Provides repeatable and accurate results every time and is easily visible across lab benches. Timer will display elapsed time or, when programmed to user defined limit, will shut off unit when time reaches zero. Display will show last used settings, even after power has been turned off.

Operating Conditions:

Unit can be run in conditions from 4 to 40°C (39 to 104°F), 20% to 85% relative humidity, non-condensing.

Ordering Information:

Mixer includes a cup head, single microplate holder, and a detachable, 3-wire cord and specified plug. Accessories that can be used on the Microplate Vortex Mixer are cup head, single microplate holder and double microplate holder. Additional accessories can be found on page 157.



Model	Speed Range	Timer	Orbit	Controls	Capacity	Duty Rating	Dimensions (L x W x H)	Item No.	Price USD
VXMPDG	On Mode 300 to 2500 rpm Touch Mode 300 to 3500 rpm	1 second to 160 hours	3.5 mm (0.13")	Touch/Standby/On Rocker Switch, LED Displays for Speed/Time, Up/Down Buttons for Set-Point Control	2 microplates	Continuous duty	10.5 x 5.4 x 4.5" (26.7 x 13.7 x 11.4 cm)	30392160	545

Microplate Vortex Mixers

- Designed for continuous duty
- Designed for shaking microplates or tubes
- Optional double microplate holder available

The OHAUS Analog Microplate Vortex Mixer is a variable speed analog mixer that is designed for continuous duty. The high speed and small orbit is optimal for effectively mixing microplates. Choose from two modes of operation: "Touch" mode which activates mixing when cup head is depressed, or "On" mode when using the microplate attachments for continuous operation.

Operating Conditions:

Unit can be run in conditions from 4 to 40°C (39 to 104°F), 20% to 85% relative humidity, non-condensing.

Ordering Information:

Mixer includes a cup head, single microplate holder, and a detachable, 3-wire cord and specified plug. Accessories that can be used on the Microplate Vortex Mixer are cup head, single microplate holder and double microplate holder. Additional accessories can be found on page 157.



Model	Speed Range	Orbit	Controls	Capacity	Duty Rating	Dimensions (L x W x H)	Item No.	Price USD
VXMPAL	On Mode 300 to 2500 rpm Touch Mode 300 to 3500 rpm	3.5 mm (0.13")	Analog	2 microplates	Continuous duty	10.5 x 5.4 x 4.5" (26.7 x 13.7 x 11.4 cm)	30392162	515

Microplate Vortex Mixer Accessories

Foam Insert for 0.5 mL Microtubes

Foam insert holds (52) 0.5 mL microtubes.

Requires Universal Holder.

Description	Item No.	Price USD
0.5 mL microtubes	30400216	38
Universal Holder	30400226	58

Foam Insert for 1.5 to 2.0 mL Microtubes

Foam insert holds (38) 1.5 to 2.0 mL microtubes.

Requires Universal Holder.

Description	Item No.	Price USD
1.5 to 2.0 mL microtubes	30400217	38
Universal Holder	30400226	58

Foam Insert for 12-13 mm Test Tubes

Foam insert holds (34) 12-13 mm diameter test tubes.

Requires Universal Holder.

Description	Item No.	Price USD
12-13 mm test tubes	30400220	38
Universal Holder	30400226	58

Foam Insert for 15-18 mm Test Tubes

Foam insert holds (20) 15-18 mm diameter test tubes.

Ideal for 15 mL centrifuge tubes.

Requires Universal Holder.

Description	Item No.	Price USD
15-18 mm test tubes	30400221	38
Universal Holder	30400226	58

Foam Insert for 19-21 mm Test Tubes

Foam insert holds (18) 19-21 mm diameter test tubes.

Requires Universal Holder.

Description	Item No.	Price USD
19-21 mm test tubes	30400222	38
Universal Holder	30400226	58

Foam Insert for 22-25 mm Test Tubes

Foam insert holds (13) 22-25 mm diameter test tubes.

Requires Universal Holder.

Description	Item No.	Price USD
22-25 mm test tubes	30400223	38
Universal Holder	30400226	58

Foam Insert for 26-29 mm Test Tubes

Foam insert holds (4) 26-29 mm diameter test tubes. Ideal for 50 mL centrifuge tubes. Requires Universal Holder.

Description	Item No.	Price USD
26-29 mm test tubes	30400224	38
Universal Holder	30400226	58

Single Tube Holder

Single tube, hands free mixing designed to fit on the Heavy-Duty Vortex Mixer. Easily attached to the top of mixer and is magnetically secured.

Accepts tubes from 2.5 to 4.5" (6.4-11.4 cm).

Minimum tube diameter is 0.75" (19 mm)

Description	Item No.	Price USD
Single Holder	30400219	156

Cup Head*

Designed for mixing 1 tube at a time.

Description	Item No.	Price USD
Cup Head	30400210	37

Small Vessel Holder

Rubber holder secures 125 and 250 mL Erlenmeyer flasks.

Vessel holder also includes a grip mat.

Requires Universal Holder.

Description	Item No.	Price USD
Small Vessel Holder	30400218	46
Universal Holder	30400226	58

Large Vessel Holder

Rubber holder secures 500 and 1000 mL Erlenmeyer flasks.

Vessel holder also includes a grip mat.

Requires Universal Holder.

Description	Item No.	Price USD
Large Vessel Holder	30400211	46
Universal Holder	30400226	58

Microplate Holder (Single)*

Designed to hold one standard microplate.

Description	Item No.	Price USD
Single Holder	30400215	56

Microplate Holder (Double)*

Designed to hold two standard microplates.

Description	Item No.	Price USD
Double Holder	30400213	63

Microplate Holder (Quad)

Designed to hold four standard microplates.

Description	Item No.	Price USD
Quad Holder	30400214	128

Stackable Microplate Holder Four

Designed to maximize the capacity of the Heavy-Duty Vortex Mixer to eight microplates by stacking the tray on top of the four plate holder.

Description	Item No.	Price USD
Stackable Holder	30400212	119

Flat Foam Insert

Ideal for custom applications. Can be cut or drilled to fit your specifications. Requires Universal Holder.

Description	Item No.	Price USD
Flat Foam Insert	30400209	38
Universal Holder	30400226	58

Universal Holder & Cover

Replacement for items supplied with Heavy-Duty Vortex Mixer. Cover allows for mixing irregularly shaped objects.

Description	Item No.	Price USD
Universal Holder	30400226	58
Universal Holder Cover	30400225	20

Unless noted with an asterisk (), for use on Heavy-Duty Vortex only.

Multi-Tube Vortex Mixers

- Process up to 50 samples at a time
- Continuous or timed operation
- Includes foam rack for 12 mm tubes

Conveniently angled front panel features rocker switch for run, time and standby modes.

Operating Features:

One piece, stainless steel housing design optimizes clean-ups. Ideal for applications requiring accuracy and repeatability. The stainless steel one piece housing design is conducive to keeping your vortexer clean and free from contaminants.

Microprocessor Control: The variable speed microprocessor control provides consistent uniform mixing action.

Adjustment Knobs: Basic speed and time knobs with 1 to 10 dial markings.

Operating Conditions:

Unit can be run in conditions from 4 to 40°C (39 to 104°F), 20% to 85% relative humidity, non-condensing.

Applications:

Suspensions, high throughput testing in clinical, environmental, and chemistry labs.

Ordering Information:

Unit includes a detachable, 3-wire cord and plug. Unit is also supplied with a Tray Pad Set for support and one 12 mm Test Tube Foam Rack (30400239). Additional accessories can be found on page 160.



Model	Speed Range*	Timer	Orbit	Maximum Weight Capacity	Duty Rating	Tray Dimensions (L x W)	Item No.	Price USD
VXMTAL	1200 to 2400 rpm	0 to 60 seconds	3.6 mm (0.14")	10 lbs (4.5 kg)	Continuous duty	7.25 x 12.25" (18.4 x 31.1 cm)	30392164	3200

* Maximum speed will vary depending on load.

Multi-Tube Vortex Mixers

- Process up to 50 samples at a time
- LED displays for speed and time
- Pulsing mode

Ideal for applications requiring accuracy and repeatability.

Operating Features:

One piece, stainless steel housing design optimizes clean-ups. Ideal for applications requiring accuracy and repeatability. The stainless steel one piece housing design is conducive to keeping your vortexer clean and free from contaminants.

Microprocessor Control: The variable speed microprocessor control provides consistent uniform mixing action.

LED Display: Touchpad controls with easy-to-read, independent LED displays for speed and time allow operator to view both settings at once. Provides repeatable and accurate results every time and is easily visible across lab benches. Timer will display elapsed time or, when programmed to user defined limit, will shut off unit when time reaches zero. Display will show last used settings, even after power has been turned off.

Pulsing Mode: Programmable pulsing mode allows user to adjust the pulse-on and pulse-off times between 1 and 59 seconds in 1 second intervals. This feature enhances the vortex action by creating a more vigorous mix.

Operating Conditions:

Unit can be run in conditions from 4 to 40°C (39 to 104°F), 20% to 85% relative humidity, non-condensing.

Applications:

Suspensions, high throughput testing in clinical, environmental, and chemistry labs.

Ordering Information:

Unit includes a detachable, 3-wire cord and plug. Unit is also supplied with a Tray Pad Set for support and one 12 mm Test Tube Foam Rack (30400239). Additional accessories can be found on page 160.

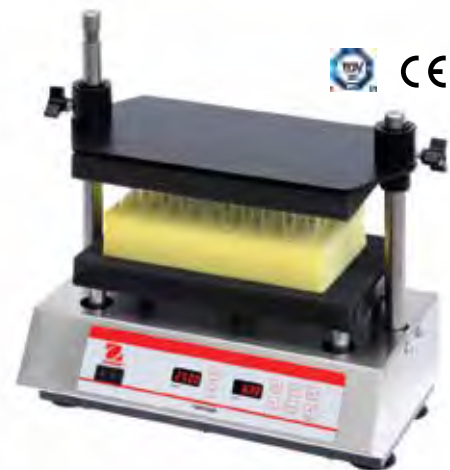

Model	Speed Range*	Speed Accuracy	Timer	Orbit	Maximum Weight Capacity	Duty Rating	Tray Dimensions (L x W)	Item No.	Price USD
VXMTDG	500 to 2500 rpm	± 25 rpm	1 second to 160 hours	3.6 mm (0.14")	10 lbs (4.5 kg)	Continuous duty	7.25 x 12.25" (18.4 x 31.1 cm)	30392171	3200

* Maximum speed will vary depending on load.

Multi-Tube Vortexer Accessories

Foam Test Tube Racks

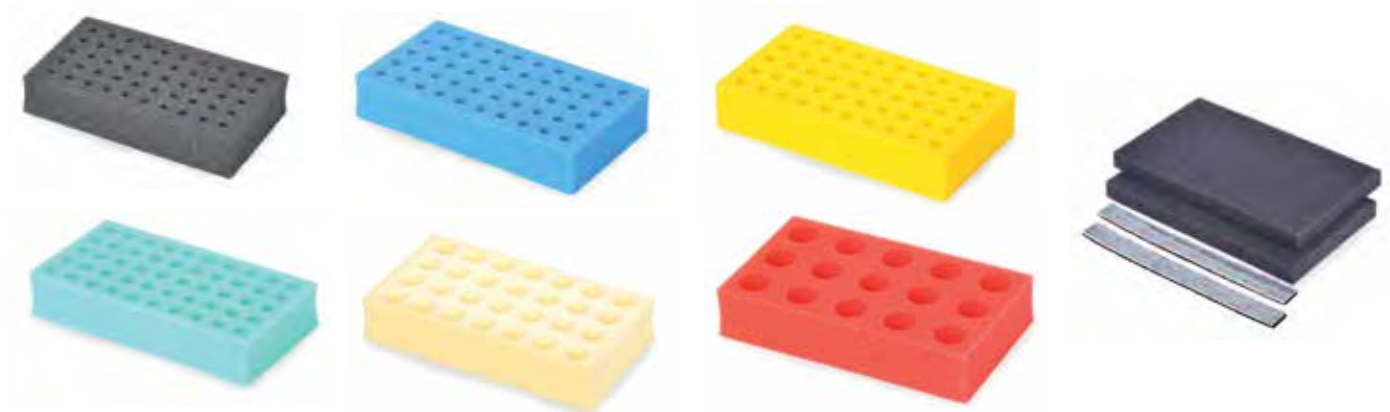

Description	Tube Capacity	Color	Dimensions (L x W x H)	Item No.	Price USD
10 mm Test Tube Foam Rack	50	Gray	5.5 × 9.5 × 2" (14 × 24.1 × 5.1 cm)	30400238	34
12 mm Test Tube Foam Rack	50	Blue	5.5 × 9.5 × 2" (14 × 24.1 × 5.1 cm)	30400239	33
13 mm Test Tube Foam Rack	50	Yellow	5.5 × 9.5 × 2" (14 × 24.1 × 5.1 cm)	30400240	33
16 mm Test Tube Foam Rack (for 15 mL centrifuge tubes)	50	Green	5.5 × 9.5 × 2" (14 × 24.1 × 5.1 cm)	30400241	44
25 mm Test Tube Foam Rack	28	White	5.5 × 9.5 × 2" (14 × 24.1 × 5.1 cm)	30400243	44
29 mm Test Tube Foam Rack (for 50 mL centrifuge tubes)	15	Red	5.5 × 9.5 × 2" (14 × 24.1 × 5.1 cm)	30400242	44
Replacement Tray Pad Set (upper & lower)	N/A	Gray	7 × 12 × 1" (17.8 × 30.5 × 2.5 cm)	30400245	49

Post Extension Kit

Adds 6" (15.2 cm) to the post of the Multi-Tube Vortex Mixer to accommodate tubes up to 10" (25.4 cm) tall.

Description	Item No.	Price USD
Post Extension Kit	30400244	176



Dry Block Heaters

- Exceptional temperature uniformity and stability
- Optional external temperature probe
- Holds interchangeable modular blocks

Designed for applications that require repeatable results and superior temperature stability. These multi-purpose units are ideal for incubation and activation of cultures, enzyme reactions, immunoassays, melting/boiling points, and a wide variety of other laboratory procedures. Integral support rod holder with locking knob accepts optional External Temperature Probe Kit. Optional External Temperature Probe Kit monitors actual block or sample temperature. Each of the five models accepts separate interchangeable modular blocks, accommodating various tube sizes from 0.2 mL micro-tubes to 50 mL centrifuge tubes. Each block has a thermometer well for measuring block temperature. Efficient heating due to close tube-and-block contact for maximum heat retention. Heaters require OHAUS modular heating blocks for operation. Modular blocks are sold separately (see pages 164 -166).

Operating Features:

Microprocessor Control: PID temperature control, with optional external RTD probe, offers a temperature stability as low as $\pm 0.1^\circ\text{C}$ with a temperature uniformity as low as $\pm 0.1^\circ\text{C}$. Samples are heated to temperature quickly and accurately. Temperature is adjusted in $\pm 0.1^\circ\text{C}$ increments.

LED Display: Touchpad controls with easy-to-read, independent LED displays for temperature, and time. Provides repeatable and accurate results every time and is easily visible across lab benches. Shows set-point and actual temperature. Timer will display elapsed time or, when programmed to user defined limit, will shut off unit when time reaches zero. Display will show last used settings, even after power has been turned off.

Temperature Calibration Mode: Allows user to calibrate unit to an external temperature device.

Safety Features:

Caution Hot Indicator: Hot warning symbol light is illuminated when the temperature is above 40°C .

Overshoot Protection: If the unit exceeds the set temperature by 10°C the unit will automatically stop heating.

Audible Alarm: In timed mode, alarm will sound when time reaches zero and when unit reaches set-point temperature.

CAUTION! To avoid possible electrical hazard, do not fill well or block opening with water or other fluids. Unit is designed as a dry bath/incubator.

Operating Conditions:

Units can be run in conditions from 18 to 33°C (64 to 91°F), 20% to 80% relative humidity, non-condensing.

Applications:

Denaturing proteins, DNA applications, ELISA and other immunoassay studies.

Ordering Information:

Units include a detachable, 3-wire cord and plug. Modular blocks are sold separately (see pages 164 -166).



External Temperature Probe Kit

Enables the unit to read actual block or sample temperature and display that temperature on the control panel. The optional External Temperature Probe Kit includes a stainless steel RTD PT100 probe, 18" (45.7 cm) stainless steel support rod, thermometer/temperature probe extension clamp and hook connector. The PT100 RTD probe is designed to fit perfectly into the thermometer well of each modular block.

Size	Temperature Range	Temperature Stability @ 37°C	Uniformity Within the Block @ 37°C	Uniformity Across Similar Blocks @ 37°C	Heat-Up Time to 100°C	Model	Item No.	Price USD
1 block	Ambient $+5^\circ\text{C}$ to 120°C	120 volt units: $\pm 0.1^\circ\text{C}$	120 volt units: $\pm 0.1^\circ\text{C}$	N/A	≤ 16 minutes	HB1DG	30392059	717
2 block				$\pm 0.1^\circ\text{C}$	≤ 16 minutes	HB2DG	30392080	799
4 block				$\pm 0.2^\circ\text{C}$	≤ 23 minutes	HB4DG	30392087	1090
6 block				$\pm 0.3^\circ\text{C}$	≤ 30 minutes	HB6DG	30392094	1424

Description	Item No.	Price USD
Optional External Temperature Probe Kit	30400246	286

Dry Block Heaters

- Multi-purpose use
- Holds interchangeable modular blocks
- Analog controls

High wattage, constant-temperature Dry Block Heaters are economical, versatile and compact. These multi-purpose units are ideal for incubation and activation of cultures, enzyme reactions, immunoassays, melting/boiling points and a wide variety of other laboratory procedures. Each of the five models accept separate interchangeable modular blocks, accommodating various sample enclosures such as microtubes, centrifuge tubes, vials, microplates, and PCR strips or tubes. Each block has a thermometer well for measuring block temperature. Anodized aluminum modular blocks provide superior temperature stability and heat transfer. Heaters require OHAUS modular heating blocks for operation. Modular blocks are sold separately (see pages 164 -166).



Operating Features:

High wattage, constant-temperature Dry Block Heaters are economical, versatile and compact.

Microprocessor Control: PID temperature controller maintains precise temperature control. Samples are heated to temperature quickly and accurately.

Adjustment Knobs: Dual temperature control knobs with dial markings from 1 to 10 for low temperature and high temperature adjustments. Low range knob adjusts from ambient to 100°C and high range knob adjusts from 75°C to 150°C.

CAUTION! To avoid possible electrical hazard, do not fill well or block opening with water or other fluids. Unit is designed as a dry bath/incubator.

Operating Conditions:

Units can be run in conditions from 18 to 33°C (64 to 91°F), 20% to 80% relative humidity, non-condensing.

Applications:

Coagulation and RH Studies.

Ordering Information:

Units include a detachable, 3-wire cord and plug. Modular blocks are sold separately (see pages 164 -166).

Size	Temperature Range	Uniformity Within the Block @ 37°C	Temperature Stability @ 37°C	Uniformity Across Similar Blocks @ 37°C	Heat-Up Time to 100°C	Model	Item No.	Price USD
1 block	Low Range: Ambient +5°C to 100°C High Range: 75°C to 150°C	120 volt units: ± 0.1°C	120 volt units: ± 1.0°C	N/A	≤ 16 minutes	HB1AL	30392045	357
2 block			120 volt units: ± 1.5°C	± 0.1°C	≤ 16 minutes	HB2AL	30392052	541
4 block			120 volt units: ± 2.0°C	± 0.2°C	≤ 23 minutes	HB4AL	30392066	835
6 block			± 0.3°C	≤ 30 minutes	HB6AL	30392073	1215	

2 Block Dry Block Heater with Lid

- Exceptional uniformity, stability, and regulation of temperature
- Heated lid reduces condensation on sample lids
- Optional external temperature probe

OHAUS Digital Dry Block Heater with Heated Lid are designed for applications that require repeatable results and superior temperature stability. These multi-purpose units are ideal for isothermal incubation, enzyme reactions, immunoassays, nucleic acid denaturation and a wide variety of other laboratory procedures. Integral support rod holder with locking knob accepts optional External Temperature Probe Kit. Optional External Temperature Probe Kit monitors actual block or sample temperature. Block heater accepts one microplate block or two separate interchangeable modular blocks, accommodating various tube sizes from 0.2 mL micro-tubes to test tubes or vials up to 85 mm in height. Each block has a thermometer well for measuring block temperature. Efficient heating due to close tube-and-block contact with a low density design for exceptional temperature uniformity. The heated lid helps to regulate the temperature and reduce the amount of condensation on sample lids. Heaters require OHAUS modular heating blocks for operation. Modular blocks are sold separately (see pages 164 -166).

Operating Features:

Microprocessor Control: PID temperature control, with optional external RTD probe, offers a temperature stability as low as $\pm 0.1^{\circ}\text{C}$ with a temperature uniformity as low as $\pm 0.1^{\circ}\text{C}$. Samples are heated to temperature quickly and accurately. Temperature is adjusted in $\pm 0.1^{\circ}\text{C}$ increments.

LED Display: Touchpad controls with easy-to-read, independent LED displays for temperature, and time. Provides repeatable and accurate results every time and is easily visible across lab benches. Shows set-point and actual temperature. Timer will display elapsed time or, when programmed to user defined limit, will shut off unit when time reaches zero. Display will show last used settings, even after power has been turned off.

Temperature Calibration Mode: Allows user to calibrate unit to an external temperature device.

Safety Features:

Caution Hot Indicator: Hot warning symbol light is illuminated when the temperature is above 40°C .

Overshoot Protection: If the unit exceeds the set temperature by 10°C the unit will automatically stop heating.

Audible Alarm: In timed mode, alarm will sound when time reaches zero and when unit reaches set-point temperature.

CAUTION! To avoid possible electrical hazard, do not fill well or block opening with water or other fluids. Unit is designed as a dry bath/incubator.

Operating Conditions:

Units can be run in environments from 18 to 33°C (64 to 91°F), 20% to 80% relative humidity, non-condensing.

Applications:

Isothermal incubation, enzyme reactions, immunoassays and nucleic acid denaturation and a wide variety of other laboratory procedures.

Ordering Information:

Units include a detachable, 3-wire cord and plug. For optional temperature probe kits see page 68. Modular blocks sold separately (see pages 164 -166).



Model	Size	Temperature Range	Temperature Stability @ 37°C	Uniformity Within the Block @ 37°C	Uniformity Across Similar Blocks @ 37°C	Heat-Up Time to 100°C	Item No.	Price USD
HB2DGHL	2 block	Ambient $+5^{\circ}\text{C}$ to 100°C	120 volt units: $\pm 0.1^{\circ}\text{C}$	120 volt units: $\pm 1.0^{\circ}\text{C}$	$\pm 0.1^{\circ}\text{C}$	≤ 30 minutes	30392101	1150

Modular Blocks & Accessories

Modular blocks are constructed from a solid anodized aluminum block*. The close contact of tubes-to-block walls allow for maximum heat retention. Each block has a thermometer well for measuring block temperature.

CAUTION! To avoid possible electrical hazard, do not fill well or block with water or other fluids. Units are designed as a dry bath/incubator.

Single block dimensions (L × W × H): 3.75 × 3 × 2" (9.5 × 7.6 × 5.1 cm)

Double block dimensions (L × W × H): 6 × 3.75 × 2.25" (15.2 × 9.5 × 5.7 cm)



Microcentrifuge Tube Blocks

Single block

Brand/Sample Type	No. of Wells	Well Dia.	Well Depth	Item No.	Price USD
0.5 mL Tube	30	7.9 mm	27.6 mm	30400157	136
1.5 mL Tube	20	11.1 mm	39.1 mm	30400159	136
1.5 mL Eppendorf™ Tube	20	11.5 mm	36.9 mm	30400162	136
2 mL Eppendorf™ Tube	20	11.5 mm	38.1 mm	30400191	136
2 mL Corning™ Tube	20	10.9 mm	38.1 mm	30400192	136

Titer Plate Block

Double block

Fits 2/4/6 block Dry Block Heaters. Ideal for 96-well or 384-well titer plates. Recessed well for better stability, flat surface good for flat and round bottom plates.

Sample Type	Well Depth	Item No.	Price USD
Titer Plate	13.5 mm	30400164	280

Conical-Bottom Centrifuge Tube Blocks

Single/Sample Type	No. of Wells	Well Dia.	Well Depth	Item No.	Price USD
15 mL Tube	12	17.1 mm	44.5 mm	30400172	136
50 mL Tube	5	29.0 mm	47.6 mm	30400168	136

Standard Test Tube Blocks

Single/Sample Type	No. of Wells	Well Dia.	Well Depth	Item No.	Price USD
6 mm Tube	30	8.3 mm	48.4 mm	30400158	136
10 mm Tube	24	10.7 mm	48.4 mm	30400151	136
12/13 mm Tube	20	13.9 mm	48.4 mm	30400152	136
12/13 mm Tube	16	13.9 mm	48.4 mm	30400165	136
15/16 mm Tube	12	17.5 mm	48.4 mm	30400153	136
17/18 mm Tube	12	19.1 mm	48.4 mm	30400195	136
20 mm Tube	8	21.0 mm	48.4 mm	30400154	136
25 mm Tube	6	26.2 mm	48.4 mm	30400155	136
35 mm Tube	4	35.0 mm	47.6 mm	30400167	136

* Block color subject to change

Modular Blocks* & Accessories

Combination Blocks

Single block

These blocks have been designed for variable sized samples.

Sample Type		No. of Wells	Well Dia.	Well Depth	Item No.	Price USD
Test Tube Combination	6 mm	6	8.3 mm	48.4 mm	30400156	136
	12/13 mm	5	13.8 mm	48.4 mm		
	25 mm	3	26.2 mm	48.4 mm		
Centrifuge Tube Combination	1.5 mL	4	11.1 mm	39.1 mm	30400193	136
	15 mL	3	17.1 mm	44.5 mm		
	50 mL	2	29.0 mm	47.6 mm		
Micro-Tube Combination	0.5 mL	6	7.9 mm	27.6 mm	30400194	136
	1.5 mL	10	11.1 mm	39.1 mm		
	2 mL	5	11.5 mm	38.1 mm		



Vial Blocks

Single block

Designed for sample/serum and scintillation vials.

Sample Type	No. of Wells	Well Dia.	Well Depth	Item No.	Price USD
12 mm Vial	20	12.7 mm	30 mm	30400182	136
15 mm Vial	20	15.8 mm	35 mm	30400183	136
16 mm Vial	15	16.4 mm	45 mm	30400190	136
17 mm Vial	12	17.8 mm	45 mm	30400184	136
19 mm Vial	12	19.7 mm	45 mm	30400185	136
21 mm Vial	9	21.7 mm	45 mm	30400186	136
23 mm Vial	8	23.8 mm	45 mm	30400187	136
25 mm Vial	8	25.8 mm	45 mm	30400188	136
28 mm Vial	6	28.8 mm	45 mm	30400189	136



PCR—Plate, Tube, Strip Blocks

Single and double block

Tapered tube wells for 0.2 mL tubes. Spaced for easy access and removal.

Sample Type	Block Size	No. of Wells	Well Dia.	Well Depth	Item No.	Price USD
96-well PCR Plate	Double	96	6.4 mm	15.5 mm	30400171	307
10 × 8 Tube Strips	Single	80	6.4 mm	15.5 mm	30400169	151
Individual Tubes	Single	64	6.4 mm	20.2 mm	30400170	151



Cuvette Block

Single block

Two parallel slots fit 6 cuvettes in each slot, side-by-side.

Sample Type	No. of Wells	Well Depth	Item No.	Price USD
(12) 12.5 mm Cuvettes	2	25.4 mm	30400161	163



* Block color subject to change

Modular Blocks* & Accessories

Solid Blocks

Single and double block

For use as a low-temperature hotplate, slide drying, or for custom drilling to make a custom block.

Block Size	Dimensions (L × W × H)	Item No.	Price USD
Single	3.75 × 3 × 2" (9.5 × 7.6 × 5.1 cm)	30400160	136
Double	6 × 3.75 × 2.25" (15.2 × 9.5 × 5.7 cm)	30400166	199



Stainless Steel Sand Baths

Ideal for irregular vessels. Stainless steel construction for superior corrosion resistance. Designed to hold sand, stainless steel shot or non-volatile fluids.

For Unit	Dimensions (L × W × H)	Item No.	Price USD
1 Block Dry Block Heater	3.8 × 3.0 × 2.5" (9.5 × 7.6 × 6.4 cm)	30400173	294
2 Block Dry Block Heater	3.8 × 5.9 × 2.5" (9.5 × 14.9 × 6.4 cm)	30400174	306
4 Block Dry Block Heater	5.8 × 7.5 × 2.5" (14.7 × 19.1 × 6.4 cm)	30400175	327
6 Block Dry Block Heater	5.8 × 11.3 × 2.5" (14.7 × 28.7 × 6.4 cm)	30400176	340



Accessories	Item No.	Price USD
Sand, 1 lb (0.45 kg)	30400177	83
Stainless Steel Shot, 1 lb (0.45 kg)	30400178	101

Low Temperature Covers

Plexiglass cover reduces air flow for additional temperature stability in low-temperature applications. Two sides are open 0.25" (6.4 mm).

Block Size	Dimensions (L × W × H)	Item No.	Price USD
2 Block Cover	6.5 × 6.5 × 1.6" (16.5 × 16.5 × 4.1 cm)	30400179	120
4 Block Cover	8.5 × 8.5 × 1.6" (21.6 × 21.6 × 4.1 cm)	30400180	117
6 Block Cover	12.5 × 8.5 × 1.6" (31.8 × 21.6 × 4.1 cm)	30400181	127



* Block color subject to change

Mini Hotplates & Stirrers

- Ergonomic design
- Hotplates & Hotplate-Stirrers boil 300 mL of water in 18 minutes
- Ideal for educational labs
- Built in support rod holder

The OHAUS Basic Mini Hotplates, Stirrers, and Hotplate-Stirrers are rugged, compact units that heat and stir up to 1000 mL of liquid. Ceramic tops feature a chemical resistant white reflective top plate that is easy to clean. Bi-metallic thermostat offers reliable temperature control. Powerful heater reaches maximum temperature in only minutes. Powerful motor and magnet deliver reliable and consistent stirring. Compact design saves bench space. Built-in support rod holder with locking knob accepts optional Support Rod and Clamp Kit.

Basic Mini Fixed Temperature Hotplate features an illuminated rocker switch to activate the preset fixed temperature of 500°C.

Basic Mini Auto-Stirrer is automatically activated by the minimum weight of a beaker or flask and will stop stirring when mixing vessel is removed.

Operating Features:

Adjustment Knobs: Basic speed and temperature control knobs with dial markings from 1 to 10.

Operating Conditions:

Units can be run in conditions from 5 to 40°C (41 to 104°F), 20% to 85% relative humidity, non-condensing.

Applications:

Academia and basic chemistry.

Ordering Information:

Units include a 3-wire cord and plug. Stirrers and Hotplate-Stirrers are supplied with a 1.5" (3.8 cm) PTFE coated stir bar.



Basic Mini Hotplates

Model	Temperature Range	Maximum Capacity (H ₂ O)	Top Plate Dimensions (Dia.)	Overall Dimensions (L x W x H)	Item No.	Price USD
HSMNHP4CAL	to 500°C*	1000 mL	4 x 4" (10.2 x 10.2 cm)	7.9 x 6 x 5" (20.1 x 15.2 x 12.7 cm)	30392010	209
HSMNHP4CFT*					30392031	199

* Fixed Temperature Hotplate has a fixed temperature of 500°C.

Basic Mini Stirrers

Model	Speed Range	Maximum Capacity (H ₂ O)	Top Plate Dimensions (Dia.)	Overall Dimensions (L x W x H)	Item No.	Price USD
HSMNST4CAL	100 to 1200 rpm	1000 mL	4 x 4" (10.2 x 10.2 cm)	7.9 x 6 x 5" (20.1 x 15.2 x 12.7 cm)	30392017	194
HSMNAS4CAL**					30392038	249

**Mini auto stirrer

Basic Mini Hotplate-Stirrers

Model	Temperature Range	Speed Range	Maximum Capacity (H ₂ O)	Top Plate Dimensions (Dia.)	Overall Dimensions (L x W x H)	Item No.	Price USD
HSMNHS4CAL	to 500°C	100 to 1200 rpm	1000 mL	4 x 4" (10.2 x 10.2 cm)	7.9 x 6 x 5" (20.1 x 15.2 x 12.7 cm)	30392024	349

HT Lysing Bead Mill Homogenizer

- Flexibility to handle multiple samples & tube configurations
- Take the guesswork out of determining optimum speed/time with 5 pre-set programs
- Increased efficiency with high-throughput sample processing
- Integral lid lock for increased safety

The HT (High Throughput) Lysing Bead Mill Lab Homogenizer offers efficient solutions for all of your grinding, lysing, pulverizing, mixing and homogenizing sample preparation applications. High-throughput processing is ideal for multiple sample and tube configurations. Easy-to-load tray securely locks the microplate or tube in place. High speed linear motion processes samples quickly. Flexibility to use OHAUS sample tubes or any other brand.

Operating Features:

LED display: Allows the operator to view speed and time settings

Microprocessor-control: Unit includes sample clamp and hex key

Applications: DNA, RNA and Protein Analysis (from mammalian tissue, plant, soil, seed, fungi, bacteria, virus and other cells), Cell Lysing, PCR, Gene Expression



Model	Speed Range	Motion	Timer	Capacity	Maximum Capacity	Item No.	Price USD
HOHTDG	300 to 1600 rpm (1 rpm increments)	Reciprocal, 31 mm	1 second to 10 minutes (1 second increments)	1 deep well plate, 4 microplates, or any sample matrix that can fit in the 10.2 × 12.7 × 6.4 cm adjustable holder	300 g	30391393	8848

Mini Lysing Bead Mill Homogenizer

- Provides an economical alternative for small batch testing
- Intuitive touchpad & display enables easy operation with excellent repeatability
- High Speed Allows for Homogenization of Tough Samples Quickly
- Clear Polycarbonate Lid With Built-In Safety Switch

The OHAUS Mini Lysing Bead Mill Homogenizer offers efficient solutions for lysing, grinding, mixing, pulverizing, and blending your most difficult samples. The high-speed, figure eight-style motion rapidly processes up to three samples quickly and efficiently at a fraction of the cost of the larger models.

Operating Features:

LED display: Allows the operator to view speed and time settings

Microprocessor-control: Tube holder for up to (3) 2 mL skirted or non-skirted tubes, built-in safety switch

Applications: DNA, RNA and Protein Analysis (from mammalian tissue, plant, soil, seed, fungi, bacteria, virus and other cells), Cell Lysing, PCR, Gene Expression



Model	Speed Range	Motion	Timer	Capacity	Item No.	Price USD
HOMNDG	2800–4000 rpm (100 rpm increments)	Figure 8	3–180 seconds (1 second increments)	3 × 2 mL skirted or non-skirted tubes	30391308	813

Bead Mill Homogenizer Tubes, Racks & Kits



Accessories	Item No.	Price USD
White, Bacteria, 2mL tube, 100/box	30391402	299
Yellow, Yeast, 2mL Tube, 100/box	30391404	299
Blue, Fungi, 2mL Tube, 100/box	30391405	299
Orange, Soft Sample, 2mL Tube, 100/box	30391406	299
Green, Plant, 2mL Tube, 100/box	30391408	299
Red, Animal Tissue, 2mL Tube, 100/box	30391409	299
Brown, Environmental, 2mL Tube, 100/box	30391410	306
Tube Rack, 25 x 2ml Tubes, 2 per pack	30391431	10
Sample Tube Kit, 14 Tubes	30391433	34

Multi-Purpose Clamps

UltraJaws Heavy-Duty Clamps

- Large grip adjustment range
- Single or dual adjust
- Available in three sizes; small, medium, and large
- Nickel-plated zinc

Our patented multi-purpose UltraJaws Heavy-Duty Clamps feature an innovative closed yoke construction that minimizes contamination and corrosion of internal components. The unique design enables secure gripping and positioning with added strength and durability.

Available in both single and dual prong adjustment, prongs open gradually to maximize grip size without binding. Both designs feature precise pressure regulation when gripping glassware surfaces to reduce the chance of breakage. UltraJaws clamps are constructed with extension rods for easy attachment to lab-frames and other apparatus. Supplied with non-slip vinyl sleeves and, for temperatures above 100°C, fiberglass covers.

The prong height of the UltraJaws Heavy-Duty Clamps make them ideal for use in holding and securing glassware with precision ground glass joints. The chart details which UltraJaws Clamps are recommended.

NOTE: An additional holder must be purchased in order to attach clamps to frames or other apparatus.

See the Connectors & Holders section of this catalog, pages 181 - 183.

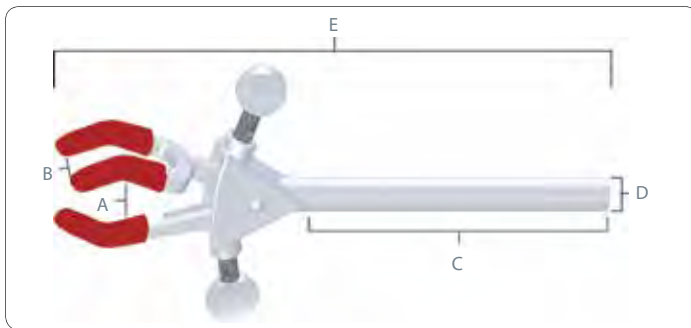

Ground Glass Joint Reference Chart

Clamp	Joint Size
Small Dual Adjust	10/30, 12/30, 14/20, 19/22, 24/40, 29/42, 34/45
Medium Dual Adjust	14/40, 19/38
Large Dual Adjust	45/50

Single Adjust Clamps



Dual Adjust Clamps



3-Prong Single Adjust Clamps

Size	(A) Min. to Max Grip Size	(B) Prong Width	(C) Arm Length	(D) Arm Dia.	(E) Overall Length	Item No.	Price USD
Small	0 to 23 mm (0 to 0.91")	6 mm (0.24")	102 mm (4")	8 mm (0.32")	162 mm (6.38")	30392254	52
Medium	0 to 50 mm (0 to 1.97")	19 mm (0.75")	127 mm (5")	11 mm (0.43")	229 mm (9.02")	30392252	53
Large	0 to 72 mm (0 to 2.83")	29 mm (1.14")	127 mm (5")	11 mm (0.43")	260 mm (10.24")	30392250	59

3-Prong Dual Adjust Clamps

Size	(A) Min. to Max Grip Size	(B) Prong Width	(C) Arm Length	(D) Arm Dia.	(E) Overall Length	Item No.	Price USD
Small	0 to 32 mm (0 to 1.26")	6 mm (0.24")	102 mm (4")	8 mm (0.32")	152 mm (5.98")	30392253	52
Medium	0 to 70 mm (0 to 2.76")	19 mm (0.75")	127 mm (5")	11 mm (0.43")	222 mm (8.74")	30392251	53
Large	0 to 103 mm (0 to 4.06")	29 mm (1.14")	127 mm (5")	11 mm (0.43")	260 mm (10.24")	30392249	59

Multi-Purpose Clamps

Heavy-Duty Tapered Clamps

Heavy-Duty, 4-prong, dual adjust tapered clamps are designed to hold large vessels with ground glass joint necks. Clamps are constructed with extension rods for easy attachment to lab-frames and other apparatus. Nickel-plated zinc construction.

NOTE: An additional holder must be purchased in order to attach clamps to frames or other apparatus.

See the Connectors & Holders section of this catalog, pages 181 - 183.



30392194



30392193

Size	Joint Size	Prong Width	Arm Length	Arm Dia.	Overall Length	Item No.	Price USD
Small	24/40 mm	16 mm (0.63")	229 mm (9.02")	13 mm (0.51")	356 mm (14")	30392193	145
Large	34/45 mm	19 mm (0.75")	229 mm (9.02")	13 mm (0.51")	381 mm (15")	30392194	145

Multi-Purpose Clamps

- Stainless steel, electro-polished finish
- Large dual adjustment range
- Available in three sizes; small, medium, and large

These durable, multi-purpose clamps are made entirely of stainless steel with an electro-polished finish and offer excellent chemical resistance and overall strength. The versatile 3-prong design secures various lab apparatus such as jointed glassware, columns, flasks, and tubes. Dual prong adjustments offer a wide range of motion. Long stainless steel extension arm offers easy positioning and depth adjustment. Autoclavable. Supplied with non-slip vinyl sleeves and, for temperatures above 100°C, fiberglass covers.

NOTE: An additional holder must be purchased in order to attach clamps to frames or other apparatus.

See the Connectors & Holders section of this catalog, pages 181 - 183.

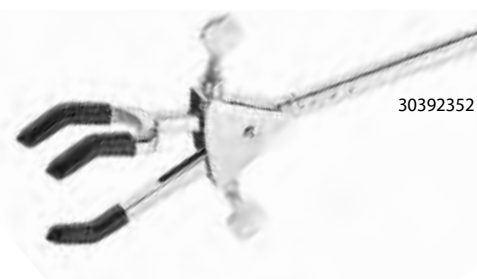

30392352



30392353



30392354

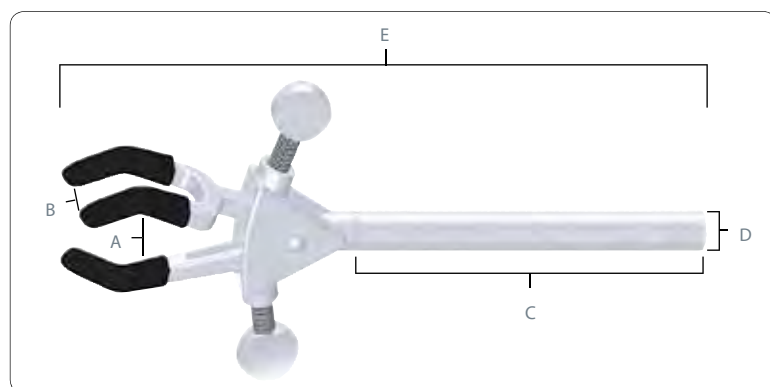

3-Prong Stainless Steel Dual Adjust Clamps

Size	(A) Min. to Max Grip Size	(B) Prong Width	(C) Arm Length	(D) Arm Dia.	(E) Overall Length	Item No.	Price USD
Small	0 to 48 mm (0 to 1.9")	13 mm (0.51")	102 mm (4")	10 mm (0.39")	172 mm (6.77")	30392354	85
Medium	0 to 69 mm (0 to 2.72")	19 mm (0.75")	127 mm (5")	13 mm (0.51")	229 mm (9.02")	30392353	98
Large	0 to 102 mm (0 to 4")	29 mm (1.14")	127 mm (5")	13 mm (0.51")	273 mm (10.75")	30392352	110

Multi-Purpose Clamps

3-Prong Multi-Purpose Clamps

- Large grip adjustment range
- 3-prong construction
- Single or dual adjust
- Nickel-plated zinc

Designed to securely hold every type of laboratory glassware and apparatus. Long, seamless nickel-plated brass tubing attaches clamp head securely and offers easy positioning in the deepest fume hoods. Clamps are constructed with round extension arms, which allow the clamps to be rotated 360°. Extension arms also allow placement of apparatus at various distances from lab-frames without compromising the integrity of your experiment. Supplied with non-slip vinyl sleeves and, for temperatures above 100°C, fiberglass covers.

NOTE: An additional holder must be purchased in order to attach clamps to frames or other apparatus. See the Connectors & Holders section of this catalog, pages 181 - 183.

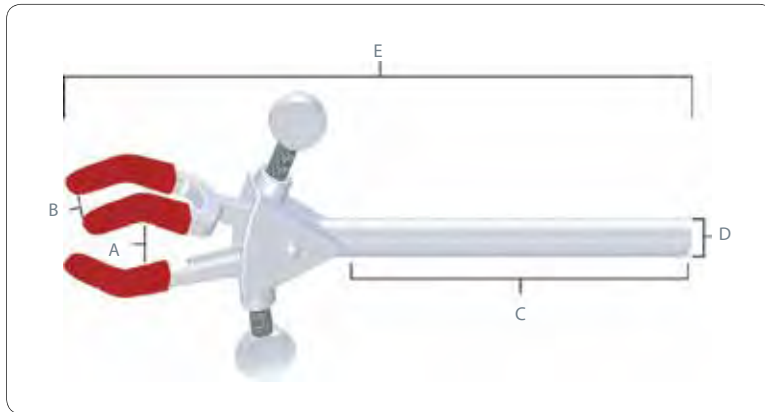

3-Prong Single Adjust Clamps



3-Prong Dual Adjust Clamps

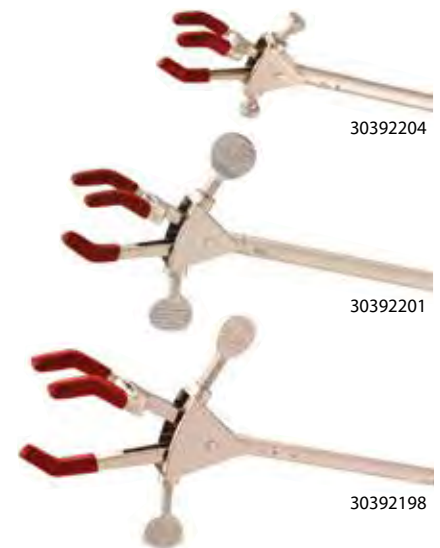

3-Prong Single Adjust Clamps

Size	(A) Min. to Max Grip Size	(B) Prong Width	(C) Arm Length	(D) Arm Dia.	(E) Overall Length	Item No.	Price USD
Small	0 to 39 mm (0 to 1.54")	11 mm (0.43")	102 mm (4")	8 mm (0.32")	160 mm (6.3")	30392205	46
Medium	0 to 71 mm (0 to 2.8")	19 mm (0.75")	127 mm (5")	11 mm (0.43")	218 mm (8.58")	30392203	49
Large	0 to 108 mm (0 to 4.25")	29 mm (1.14")	127 mm (5")	11 mm (0.43")	248 mm (9.76")	30392200	51

3-Prong Dual Adjust Clamps

Size	(A) Min. to Max Grip Size	(B) Prong Width	(C) Arm Length	(D) Arm Dia.	(E) Overall Length	Item No.	Price USD
Small	0 to 46 mm (0 to 1.81")	11 mm (0.43")	102 mm (4")	8 mm (0.32")	168 mm (6.61")	30392204	46
Medium	0 to 69 mm (0 to 2.72")	19 mm (0.75")	127 mm (5")	11 mm (0.43")	229 mm (9.02")	30392201	49
Medium (extended)	0 to 69 mm (0 to 2.72")	19 mm (0.75")	305 mm (12")	13 mm (0.5")	406 mm (16")	30392202	60
Large	0 to 105 mm (0 to 4.13")	29 mm (1.14")	127 mm (5")	11 mm (0.43")	273 mm (10.75")	30392198	51
Large (extended)	0 to 105 mm (0 to 4.13")	29 mm (1.14")	305 mm (12")	13 mm (0.5")	451 mm (17.76")	30392199	63

Multi-Purpose Clamps

2-Prong Multi-Purpose Clamps

- Stainless steel electro-polished finish or nickel-plated zinc
- Large grip adjustment range
- 2-prong construction
- Single or dual adjust

Designed to securely hold laboratory glassware and apparatus. Extension arm attaches clamp head securely and offers easy positioning in the deepest fume hoods. Clamps are constructed with round extension arms, which allow the clamps to be rotated 360°. Extension arms also allow placement of apparatus at various distances from lab-frames without compromising the integrity of your experiment. Stainless steel clamps are electro-polished and made entirely of stainless steel. They offer exceptional chemical resistance and are autoclavable. Nickel-plated zinc offers a clamp with a high tensile strength at an economical price. Supplied with non-slip vinyl sleeves and, for temperatures above 100°C, fiberglass covers.

NOTE: An additional holder must be purchased in order to attach clamps to frames or other apparatus. See the Connectors & Holders section of this catalog, pages 181 - 183.

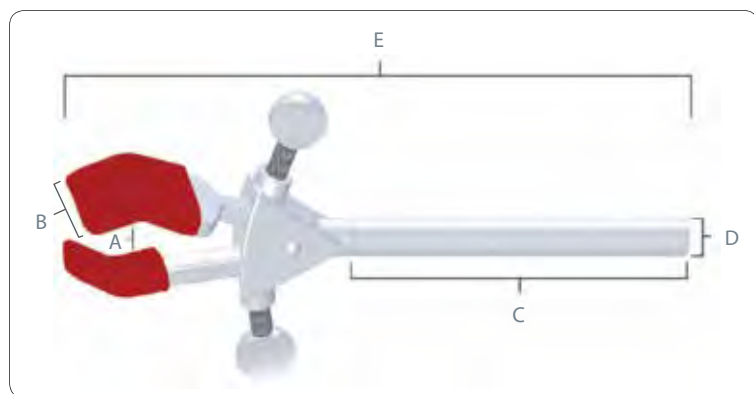

2-Prong Single Adjust Clamps



2-Prong Dual Adjust Clamps



2-Prong Single Adjust Clamps

Material	Size	(A) Min. to Max Grip Size	(B) Prong Width	(C) Arm Length	(D) Arm Dia.	(E) Overall Length	Item No.	Price USD
Nickel-plated zinc	Medium	0 to 78 mm (0 to 3.07")	23 mm (0.91")	127 mm (5")	11 mm (0.43")	216 mm (8.5")	30392208	37
Nickel-plated zinc	Large	0 to 92 mm (0 to 3.62")	23 mm (0.91")	127 mm (5")	11 mm (0.43")	229 mm (9.02")	30392206	40

2-Prong Dual Adjust Clamps

Material	Size	(A) Min. to Max Grip Size	(B) Prong Width	(C) Arm Length	(D) Arm Dia.	(E) Overall Length	Item No.	Price USD
Stainless steel	Medium	0 to 75 mm (0 to 2.95")	23 mm (0.91")	127 mm (5")	11 mm (0.43")	229 mm (9.02")	30392220	91
Nickel-plated zinc	Medium	0 to 75 mm (0 to 2.95")	23 mm (0.91")	127 mm (5")	11 mm (0.43")	229 mm (9.02")	30392209	37
Stainless steel	Large	0 to 95 mm (0 to 3.74")	23 mm (0.91")	127 mm (5")	11 mm (0.43")	248 mm (9.76")	30392223	108
Nickel-plated zinc	Large	0 to 95 mm (0 to 3.74")	23 mm (0.91")	127 mm (5")	11 mm (0.43")	248 mm (9.76")	30392207	40

Multi-Purpose Clamps

Swivel Clamps

Used to hold apparatus near the lab-frame. Unlike extension clamps, the swivel clamps have an integral holder for attaching to a lab-frame or other apparatus. Built-in holder grips rods up to 19 mm (0.75") in diameter and is adjustable for forward or reverse-facing adjustment screws. Shaft wing-nut allows the holding angle of the swivel clamp to adjust through 360° of rotation and can be locked in place once desired position is achieved. Stainless steel electro-polished finish or nickel-plated zinc construction. Supplied with non-slip vinyl sleeves and, for temperatures above 100°C, fiberglass covers.



Material	Description	Size	Min. to Max. Grip Size	Prong Width	Overall Length	Item No.	Price USD
Stainless steel	2-Prong Single Adjust	Medium	0 to 76 mm (0 to 3")	23 mm (0.91")	163 mm (6.42")	30392226	105
Nickel-plated zinc	2-Prong Single Adjust	Medium	0 to 76 mm (0 to 3")	23 mm (0.91")	163 mm (6.42")	30392215	37
Nickel-plated zinc	2-Prong Single Adjust	Large	0 to 95 mm (0 to 3.74")	23 mm (0.91")	180 mm (7.09")	30392216	39
Stainless steel	3-Prong Dual Adjust	Medium	0 to 69 mm (0 to 2.72")	20 mm (0.79")	178 mm (7.01")	30392225	142
Nickel-plated zinc	3-Prong Dual Adjust	Medium	0 to 69 mm (0 to 2.72")	20 mm (0.79")	178 mm (7.01")	30392214	52

Fixed-Position Clamps

Used to hold apparatus near the lab-frame where no adjustment is required after set-up. Built-in holder grips rods up to 19 mm (0.75") in diameter Fixed-Position Clamps have an integral holder but can be rotated after attachment to a lab-frame or other apparatus. Available in 2-prong or 3-prong. Stainless steel electro-polished finish or nickel-plated zinc construction. Supplied with non-slip vinyl sleeves and, for temperatures above 100°C, fiberglass covers.



Material	Description	Size	Min. to Max. Grip Size	Prong Width	Overall Length	Item No.	Price USD
Stainless steel	2-Prong Single Adjust	Medium	0 to 77 mm (0 to 3.03")	23 mm (0.91")	133 mm (5.24")	30392230	104
Nickel-plated zinc	2-Prong Single Adjust	Medium	0 to 77 mm (0 to 3.03")	23 mm (0.91")	133 mm (5.24")	30392218	35
Stainless steel	3-Prong Dual Adjust	Medium	0 to 69 mm (0 to 2.72")	20 mm (0.79")	146 mm (5.75")	30392229	131
Nickel-plated zinc	3-Prong Dual Adjust	Medium	0 to 69 mm (0 to 2.72")	20 mm (0.79")	146 mm (5.75")	30392217	44

Specialty Clamps

Thermometer Swivel Clamp

Holds glass tubes and thermometers 114 mm (4.49") from support rod. Clamp features safety adjust spring plate jaws that adjust to any angle with locking wing-nut. Built-in holder grips rods up to 19 mm (0.75") in diameter. Lightweight, rust, and corrosion-resistant. Nickel-plated construction.

Min. to Max. Grip Size	Overall Length	Item No.	Price USD
6 to 8 mm (0.24 to 0.32")	159 mm (6.26")	30392238	44



30392238

Thermometer / Thermocouple Extension Clamp

Lightweight clamp holds glass tubing, thermometers or thermocouples up to 178 mm (7") from support rod. Tightening wing-nut applies tension to the nickel-plated jaws.

NOTE: An additional holder must be purchased in order to attach clamps to frames or other apparatus.

See the Connectors & Holders section of this catalog, pages 181 - 183.

Min. to Max. Grip Size	Ext Arm Length	Arm Dia.	Overall Length	Item No.	Price USD
6 to 12 mm (0.24 to 0.47")	127 mm (5")	11 mm (0.43")	210 mm (8.27")	30392239	38



30392239

Wall Clamp

Ideal for securing fermentation tubes, burets or other small objects to walls where no frames are available. Integral self-tapping screw secures clamp to wall. Nickel-plated construction.

Min. to Max. Grip Size	Overall Length	Item No.	Price USD
5 to 10 mm (0.2 to 0.39")	80 mm (3.15")	30392244	33



30392244

Water Bath Clamps

Holds a variety of apparatus, including glass tubes and thermometers onto glass water bath walls. Built-in holder grips walls of varying thickness, up to 9 mm (0.35"). Knurled thumbscrew tightens jaws to hold objects firmly. Nickel-plated zinc construction. Large water bath clamp is supplied with non-slip vinyl sleeves and, for temperatures above 100°C, fiberglass covers.

Size	Min. to Max. Grip Size	Prong Width	Overall Length	Item No.	Price USD
Small	5 to 10 mm (0.2 to 0.39")	N/A	89 mm (3.5")	30392240	32
Large	0 to 46 mm (0 to 1.81")	11 mm (0.43")	117 mm (4.61")	30392241	49



30392240



30392241

Specialty Clamps

For the items listed below an additional holder must be purchased in order to attach clamps to frames or other apparatus. See the Connectors & Holders section of this catalog, pages 181 - 183.

Chain Clamps

Holds large round or irregular shaped objects firmly, yet gently, to lab-frames and rods. Quick and secure slip-on chain connection with large, easy-to-turn adjusting knob. Extension arm allows user to vary distance from the frame. Available as stainless steel clamp, constructed entirely of stainless steel with electro-polished finish or nickel-plated zinc clamp with strong, chromed-brass chain.

Stainless Steel

Size	Min. to Max. Dia.	Ext. Arm Length	Arm Dia.	Overall Length	Item No.	Price USD
Large-5	35 to 280 mm (1.38 to 11.02")	127 mm (5")	13 mm (0.51")	206 mm (8.11")	30392224	227



30392224
(shown in stainless steel)

Nickel-Plated Zinc

Size	Min. to Max. Dia.	Ext. Arm Length	Arm Dia.	Overall Length	Item No.	Price USD
Small	35 to 170 mm (1.38 to 6.69")	127 mm (5")	13 mm (0.51")	188 mm (7.4")	30392235	63
Large-5	35 to 280 mm (1.38 to 11.02")	127 mm (5")	13 mm (0.51")	206 mm (8.11")	30392259	92
Large-12	35 to 280 mm (1.38 to 11.02")	305 mm (12")	13 mm (0.51")	384 mm (15.12")	30392260	97

Column Clamps

These sturdy, easily adjusted, multi-purpose clamps are ideal for holding large cylindrical glassware and similar objects. A large, flat thumbscrew/worm-drive permits maximum tightening or removal in minimum time. Clamp is constructed of corrosion-resistant stainless steel. Ideal for chromatography columns.

Size	Min. to Max. Dia.	Ext. Arm Length	Arm Dia.	Overall Length	Item No.	Price USD
Small	65 to 89 mm (2.56 to 3.5")	211 mm (8.31")	11 mm (0.43")	282 mm (11.1")	30392314	74
Medium	91 to 114 mm (3.58 to 4.49")	211 mm (8.31")	11 mm (0.43")	315 mm (12.4")	30392315	76
Large	64 to 140 mm (2.52 to 5.51")	211 mm (8.31")	11 mm (0.43")	338 mm (13.31")	30392316	77
X-Large	92 to 165 mm (3.62 to 6.5")	211 mm (8.31")	11 mm (0.43")	368 mm (14.49")	30392317	77



30392316

Specialty Clamps

For the items listed below an additional holder must be purchased in order to attach clamps to frames or other apparatus. See the Connectors & Holders section of this catalog, pages 181 - 183.

Nester Extension Clamps

Securely holds large or small glass distillation columns and odd-shaped glassware. Constructed of stainless steel with strong, chromed-brass band and chain.

Min. to Max. Dia.	Ext. Arm Length	Arm Dia.	Overall Length	Item No.	Price USD
50 to 102 mm (1.97 to 4")	152 mm (5.98")	10 mm (0.39")	262 mm (10.32")	30392318	98



30392318

PVC Coated Open Extension Rings

Ideal for supporting funnels, round bottom flasks, reaction vessels, and other apparatus that require lower support. Opening in PVC coated aluminum ring allows for easy removal of sample container. PVC coating protects glassware. Long extension arm permits depth adjustment of the open ring from the lab-frame or ring stand.

Ring Dia.	Ext. Arm Length	Arm Dia.	Overall Length	Item No.	Price USD
76 mm (3")	254 mm (10")	9 mm (0.35")	328 mm (12.91")	30392346	69
102 mm (4")	305 mm (12")	9 mm (0.35")	404 mm (15.91")	30392347	78
127 mm (5")	305 mm (12")	11 mm (0.43")	427 mm (16.81")	30392348	103



30392347

Open Rings

Lightweight rings mount funnels, boiling flasks, and other irregular shaped objects to lab-frames. Open ring section allows items to pass in and out of support area easily, reducing risk of breakage. Aluminum construction.

Ring Dia.	Ext. Arm Length	Arm Dia.	Overall Length	Item No.	Price USD
76 mm (3")	58 mm (2.28")	9 mm (0.35")	132 mm (5.2")	30392343	32
102 mm (4")	58 mm (2.28")	9 mm (0.35")	158 mm (6.22")	30392344	42
127 mm (5")	61 mm (2.4")	11 mm (0.43")	183 mm (7.2")	30392345	58



30392345

Specialty Clamps

Buret Holders

Stainless steel electro-polished finish or nickel-plated zinc construction. Double Buret Clamp holds any size buret from micro to 100 mL capacity. Simply compress the scissor-like mechanism, insert buret and gently release to grip. Numbers and graduation on buret remain easy to read. For height adjustments, recompress mechanism and slide buret up or down and gently release. Clamp unit with built-in reinforced hook connector attaches to optional standard support rod. Adjusting nut faces forward for easy use. Stainless steel or aluminum support rod attaches to optional porcelain base.

Support Rod (Dia. × L): 13 × 578 mm (0.51 × 22.76")

Porcelain Base (L × W × H): 178 × 330 × 25 mm (7 × 13 × 1")

Stainless Steel

Description	Item No.	Price USD
Double Buret Clamp (only)	30392227	181
Support Rod (only)	30392233	40
Support Stand with Rod	30392232	202
Double Buret Clamp & Support Stand with Rod (complete)	30392231	373

Nickel-Plated Zinc

Description	Item No.	Price USD
Double Buret Clamp (only)	30392234	66
Support Stand with Rod	30392312	187
Double Buret Clamp & Support Stand with Rod (complete)	30392313	260



30392231
(shown in stainless steel)

Kettle Clamps

Holds flask and cover together firmly. Three insulated spring-activated clamping arms. Stainless steel springs. For use on reaction kettles.

Flask Size	Inside Dia.	Item No.	Price USD
500 mL, 1000 mL	125 mm (4.92")	30392365	178
2000 mL, 3000 mL, 4000 mL	142 mm (5.59")	30392366	180



30392365

Electrode Support Clamp

Permits suspension of electrodes over beaker for potentiometric titrations. Holds any electrode clamp at desired level. Built-in nickel-plated zinc holder grips rods up to 19 mm (0.75") in diameter.

Overall Length	Item No.	Price USD
178 mm (7")	30392242	70



30392242
Electrode holder not included

Suspension Clamp

Holds thermometers, potash bulbs or drying tubes 114 mm (4.49") from support rod. Machine tapered, nickel-plated brass hook won't bend, rust, or corrode. Built-in holder grips rods up to 19 mm (0.75") in diameter.

Overall Length	Item No.	Price USD
137 mm (5.39")	30392243	33



30392243

Support Clamp

Supports electrolysis apparatus, glass rods or tubing at any angle. Arms are nickel-plated brass with vinyl coating. Easily supports cylindrical objects up to 19 mm (0.75") in diameter. Built-in holder grips rods up to 19 mm (0.75") in diameter.

Overall Length	Prong Width	Item No.	Price USD
152 mm (5.99")	25 mm (1")	30392237	90



30392237

Specialty Clamps

Ultra Flex Support Systems have unique flexible arms that are extremely versatile and can be placed in virtually any position or angle. Ultra Flex comes in three different systems; base plate, lab-frame connector, and bench clamp. Each system includes a 2-Prong Clamp Head, 3-Prong Clamp Head, Spring Clamp Head, nickel-plated flex arm in 305 mm (12") or 457 mm (18") length, and utility wrench. 2-prong and 3-prong clamp heads also supplied with non-slip vinyl sleeves and, for temperatures above 100°C, fiberglass covers.

Arm Length	Ultra Flex 12 Ultra Flex 18	305 mm (12") 457 mm (18")
Arm Diameter		13 mm (0.51")
Max. Grip Size	2-Prong Clamp Head 3-Prong Clamp Head Spring Clamp Head	75 mm (2.95") 69 mm (2.72") 13 mm (0.51")

2-Prong Clamp Head



3-Prong Clamp Head



Spring Clamp Head



Ultra Flex Support System with Base Plate

OHAUS Ultra Flex Support System with Base Plate is constructed of all metal and designed with a stable, painted steel base plate with chemical resistant black finish that fits easily on bench tops or in fume hoods. Base plate measures 127 × 127 × 12.7 mm (5 × 5 × 0.5").

Description	Item No.	Price USD
Ultra Flex 12 with Base Plate	30400011	294
Ultra Flex 18 with Base Plate	30400014	354



30400014

Ultra Flex Support System with Lab-Frame Connector

Ultra Flex Support System with Lab-Frame Connector securely attaches to support stands, lab-frames, or any support rod up to 19 mm (0.75") in diameter. Ideal for use in fume hoods. Lab-frame connector is made of cast alloy.

Description	Item No.	Price USD
Ultra Flex 12 with Lab-Frame Connector	30400013	227
Ultra Flex 18 with Lab-Frame Connector	30400016	271



30400013

Ultra Flex Support System with Bench Clamp

Ultra Flex Support System with Bench Clamp easily attaches to the side of your lab bench or counter top, which helps utilize more space in your lab. Bench clamp is constructed of aluminum.

Description	Item No.	Price USD
Ultra Flex 12 with Bench Clamp	30400012	261
Ultra Flex 18 with Bench Clamp	30400015	311



30400015

Specialty Clamps

Bench Clamp

Aluminum bracket with arm fastens quickly and firmly to any convenient shelf. Accepts 13 mm (0.51") rods vertically and horizontally, to which ordinary rings and clamps attach, leaving bench surface clear for apparatus.

Clamp Opening	Depth of Grip	Overall Length	Item No.	Price USD
1.7" (43 mm)	2" (51 mm)	7.75" (197 mm)	30392311	237



30392311

Thumbscrew Knob

Thumbscrew tightening knob features a 32 mm (1.25") slot in the center of a nylon disc that will accept thumbscrews supplied with the LabJaws and UltraJaws Multi-Purpose Clamps, excluding the stainless steel version. Makes tightening of clamps easier on the hands and wrists.

Overall Diameter	Thumbscrew Slot	Item No.	Price USD
64 mm (2.5")	32 mm (1.25")	30392192	46



30392192

Double Jaw Utility Clamp

Swivels 360° and locks securely in desired position. These 2-prong clamps have a medium and a large clamp on each end. Nickel-plated zinc construction. Supplied with non-slip vinyl sleeves and, for temperatures above 100°C, fiberglass covers.



30392236

Description	Min. to Max. Grip Size	Prong Width	Overall Length	Item No.	Price USD
Medium 2-Prong	0 to 76 mm (0 to 3")	23 mm (0.91")	222 mm (8.74")	30392236	47

Connectors & Holders

Regular Holder

Stainless steel electro-polished finish or nickel-plated zinc construction. Ideal for holding clamps to lab-frames. Use wherever clamping at 90° is required.

Material	Min. to Max. Grip Size	Item No.	Price USD
Stainless steel	0 to 18 mm (0 to 0.71")	30392219	59
Nickel-plated zinc	0 to 18 mm (0 to 0.71")	30392197	24



30392219
(shown in stainless steel)

Jumbo Holder

Stainless steel electro-polished finish or aluminum construction. Ideal for holding clamps to lab-frames or ring stands.

Material	Min. to Max. Grip Size	Item No.	Price USD
Stainless steel	0 to 21 mm (0 to 0.83")	30392357	59
Aluminum	0 to 21 mm (0 to 0.83")	30392196	35



30392357
(shown in stainless steel)

Heavy-Duty Holder

For mounting stirrers and other apparatus. Holder is constructed of strong aluminum alloy; fitted with oversized knobs for very secure positioning. Rods supported on 102 mm (4") long surface to avoid vibration and wobble.

Material	Min. to Max. Grip Size	Item No.	Price USD
Aluminum	6 to 24 mm (0.24 to 0.95")	30400045	99



30400045

Swivel Holder

Two rod holders with center swivel capacity allow tilting of clamps at any angle in parallel planes. Outside adjustment screw allows close proximity between items being held. Stainless steel electro-polished or nickel-plated zinc construction.

Material	Min. to Max. Grip Size	Item No.	Price USD
Stainless steel	0 to 19 mm (0 to 0.75")	30392228	95
Nickel-plated zinc	0 to 19 mm (0 to 0.75")	30392213	32



30392228
(shown in stainless steel)

All-Position Clamp Holder

Surpasses standard holding capabilities. The all-position clamp holder permits adjustment at any angle in any plane. Holders are set at 90° to each other, connected by a 90° connector, allowing 360° rotation. Nickel-plated zinc construction.

Material	Min. to Max. Grip Size	Item No.	Price USD
Nickel-plated zinc	0 to 19 mm (0 to 0.75")	30392248	64



30392248

Clamp Holder

Clamp is ideal for gripping 2 rods at 90°. Oversized thumbscrews make securing rods fast and easy.

Material	Min. to Max. Grip Size	Overall Length	Item No.	Price USD
Aluminum	0 to 17 mm (0 to 0.66")	70 mm (2.75")	30392195	22



30392195

Connectors & Holders

Hook Connector

Stainless steel electro-polished finish or nickel-plated zinc construction. Simple, versatile, and easy-to-use. Hook connectors allow one-handed assembly of two components with one adjustment screw.

Material	Min. to Max. Grip Size	Item No.	Price USD
Stainless steel	0 to 13 mm (0 to 0.51")	30392358	33
Nickel-plated zinc	0 to 13 mm (0 to 0.51")	30392258	13



30392358
(shown in stainless steel)

End-to-End Connector

Extend the length of lab-frame rods. Strong aluminum alloy connector permits end-to-end joining of rods. Precision boring of connector ensures perfect alignment of rods. Corrosion resistant. Comes with two set screws.

Material	Min. to Max. Grip Size	Item No.	Price USD
Aluminum	0 to 13 mm (0 to 0.51")	30392264	25



30392264

Rod End Connector

Holds rods firmly at 90°. Use when semi-permanent installations are required. Comes with two set screws and is precision bored for close fit. Stainless steel electro-polished finish or nickel-plated zinc construction.

Material	Min. to Max. Grip Size	Item No.	Price USD
Stainless steel	0 to 13 mm (0 to 0.51")	30392222	38
Nickel-plated zinc	0 to 13 mm (0 to 0.51")	30392256	16



30392222
(shown in stainless steel)

S-Connector

Stainless steel electro-polished finish or nickel-plated zinc construction. Clamp is ideal for constructing lab-frames or other supports requiring the connection of two perpendicular rods. Clamp connects two 13 mm (0.51") rods at a 90° angle and features separate adjustment screws for each rod location.

Material	Min. to Max. Grip Size	Item No.	Price USD
Stainless steel	0 to 13 mm (0 to 0.51")	30392355	35
Nickel-plated zinc	0 to 13 mm (0 to 0.51")	30392257	23



30392355
(shown in stainless steel)

Frame Connector (Pack of 12)

Improved contour delivers simplicity and strength. Angled adjustment screws allow easy set-up and prevents misalignment. Smooth, rounded surfaces are easy-to-clean. Small size maximizes lab-frame space. Bright dipped aluminum finish sealed with silicon for maximum protection against corrosion.

Material	Min. to Max. Grip Size	Item No.	Price USD
Aluminum	0 to 13 mm (0 to 0.51")	30392255	220



30392255

Connectors & Holders

Universal Stirrer Mounting Bracket

Use to mount stirrers and other devices to lab-frames. Aluminum mounting bracket with attachment screws.

Max. Weight Mounted	Min. to Max. Grip Size	Item No.	Price USD
2.27 kg (5 lbs)	0 to 20 mm (0 to 0.78")	30392265	10



30392265

Multi-Rod Connector

Maximum adjustment capability within one connector. Two adjustment rods fit into the oval hole in the connector, preventing turning when tightened. Side and front 13 mm (0.51") holes allow creation of a variety of configurations. Nickel-plated zinc construction.

Min. to Max. Rod Size	Item No.	Price USD
0 to 13 mm (0 to 0.51")	30392262	38



30392262

Wrench

Special adjusting wrench is for use with lab-frame items with set screws.

Length	Item No.	Price USD
79 mm (3.11")	30392270	38



30392270

Channel Connector

Special connector fastens lab-frame rod to steel 41 mm (1.61") channels. Loosen the connector and slide up or down for easy adjustment of rod position.

Dimensions	Item No.	Price USD
33 x 40 mm (1.3 x 1.58")	30392261	56

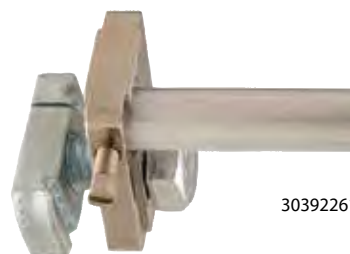

30392261

Horizontal Mounting Bars with Coupler

Threaded end for direct installation into channels. Comes with spring coupler for use in steel 41 mm (1.61") channels. Locking nut included. Use with steel channel frames.

Bar Length	Item No.	Price USD
51 mm (2")	30392266	24
102 mm (4")	30392267	29
152 mm (6")	30392268	32
203 mm (8")	30392269	35



30392268

Rods, Frames, & Supports

Lab Frame Foot

Stainless steel electro-polished finish or nickel-plated zinc construction. Strong, durable lab-frame foot is designed for mounting lab-frames permanently to bench tops, fume hoods, walls, and floors. Spilled fluids roll right off the smooth body contour, minimizing contamination and easing clean-ups. Features a set screw and includes three 19 mm (0.75") mounting screws.

Material	Min. to Max. Grip Size	Dimensions (Dia. × H)	Item No.	Price USD
Stainless steel	0 to 0.51" (0 to 13 mm)	2.3 × 1.25" (58 × 32 mm)	30392356	52
Nickel-plated zinc	0 to 0.51" (0 to 13 mm)	2.3 × 1.25" (58 × 32 mm)	30392263	26



30392356
(shown in stainless steel)

Frame Rods

Everything you need to customize a lab-frame to your laboratory space. Quality construction throughout. Frame rods are available in many lengths and materials.

Aluminum

Center-less ground for a precise fit. These hard aluminum rods provide a smooth fit with lab-frames. Corrosion resistant with chamfered ends for easy location.



Stainless Steel

Heavy-duty, top-of-the-line rods provide maximum strength and durability. Constructed of 303 stainless steel.

Material	Rod Diameter	Rod Length	Stainless Steel Item No.	Price USD
Stainless Steel	0.51" (13 mm)	1.61" (41 mm)	30392293	10
Stainless Steel	0.51" (13 mm)	2" (51 mm)	30392294	10
Stainless Steel	0.51" (13 mm)	6" (152 mm)	30392295	13
Stainless Steel	0.51" (13 mm)	12" (305 mm)	30392296	23
Stainless Steel	0.51" (13 mm)	18" (457 mm)	30392297	30
Stainless Steel	0.51" (13 mm)	24" (610 mm)	30392298	38
Stainless Steel	0.51" (13 mm)	36" (914 mm)	30392299	53
Stainless Steel	0.51" (13 mm)	48" (1219 mm)	30392300	67
Stainless Steel	0.51" (13 mm)	60" (1524 mm)	30392301	79
Stainless Steel	0.51" (13 mm)	72" (1829 mm)	30392302	94
Stainless Steel	0.51" (13 mm)	96" (2438 mm)	30392303	122
Aluminum	0.51" (13 mm)	1.61" (41 mm)	30392271	6
Aluminum	0.51" (13 mm)	2" (51 mm)	30392272	9
Aluminum	0.51" (13 mm)	6" (152 mm)	30392273	11
Aluminum	0.51" (13 mm)	12" (305 mm)	30392274	17
Aluminum	0.51" (13 mm)	18" (457 mm)	30392275	18
Aluminum	0.51" (13 mm)	24" (610 mm)	30392276	23
Aluminum	0.51" (13 mm)	36" (914 mm)	30392277	25
Aluminum	0.51" (13 mm)	48" (1219 mm)	30392278	39
Aluminum	0.51" (13 mm)	60" (1524 mm)	30392279	45
Aluminum	0.51" (13 mm)	72" (1829 mm)	30392280	50
Aluminum	0.51" (13 mm)	96" (2438 mm)	30392281	63

Rods, Frames, & Supports

LabJaws offers the widest choice of standard lab frames available, plus the accessories to custom-fit any laboratory with the right frame for the job. Standard Lab-Frame sets are available in five sizes. Options of traditional center-less ground aluminum, non-corroding fiberglass, or tough stainless steel rods are available. Nickel-plated zinc connectors and lab-frame feet are standard with all kits.

Small Lab-Frame

Vertical mounting, great for glassware set-ups in small laboratories or where space is limited. Frame measures 24 × 24" (610 × 610 mm). Base is 18" (457 mm) wide for stability. Base may be permanently mounted to bench top with screws (included).

Components:

- (8) 2" (51 mm) Rods
- (2) 18" (457 mm) Rods
- (8) 24" (610 mm) Rods
- (18) S-Connectors
- (4) Rod End Connectors
- (4) Lab-Frame Feet



Material	Frame Dimensions	Base Dimensions	Item No.	Price USD
Stainless Steel	24 × 24" (610 × 610 mm)	18" (457 mm) wide	30392323	820
Aluminum	24 × 24" (610 × 610 mm)	18" (457 mm) wide	30392304	479

Medium Lab-Frame

Horizontal or vertical mounting, convenient for distillation or general set-up. Frame measures 24 × 48" (610 × 1219 mm). Base is 18" (457 mm) wide for stability.

Components:

- (8) 2" (51 mm) Rods
- (2) 18" (457 mm) Rods
- (7) 24" (610 mm) Rods
- (4) 48" (1219 mm) Rods
- (35) S-Connectors
- (4) Rod End Connectors
- (4) Lab-Frame Feet



Material	Frame Dimensions	Base Dimensions	Item No.	Price USD
Stainless Steel	24 × 48" (610 × 1219 mm)	18" (457 mm) wide	30392324	1161
Aluminum	24 × 48" (610 × 1219 mm)	18" (457 mm) wide	30392305	603

Rods, Frames, & Supports

Large Lab-Frame

This 48 × 48" (1219 × 1219 mm) frame is ideal for complex glassware set-ups. Base is 18" (457 mm) wide for stability.

Components:

- (10) 2" (51 mm) rods
- (3) 18" (457 mm) rods
- (2) 36" (914 mm) rods
- (10) 48" (1219 mm) rods
- (38) S-Connectors
- (4) Rod End Connectors
- (6) Lab-Frame Feet



Material	Frame Dimensions	Base Dimensions	Item No.	Price USD
Stainless Steel	48 × 48" (1219 × 1219 mm)	18" (457 mm) wide	30392325	1638
Aluminum	48 × 48" (1219 × 1219 mm)	18" (457 mm) wide	30392306	933

Extra-Large Lab-Frame

Versatile, adaptable Extra-Large Lab-Frame measures 48 × 72" (1219 × 1829 mm) and may be used either horizontally or vertically.

Components:

- (6) 2" (51 mm) rods
- (6) 12" (305 mm) rods
- (2) 24" (610 mm) rods
- (7) 48" (1219 mm) rods
- (5) 72" (1829 mm) rods
- (45) S-Connectors
- (4) Rod End Connectors
- (8) Lab-Frame Feet

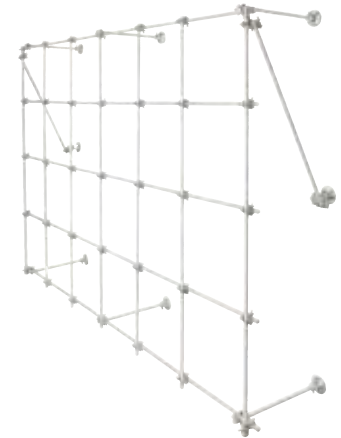

Material	Frame Dimensions	Stainless Steel Item No.	Price USD
Stainless Steel	48 × 72" (1219 × 1829 mm)	30392326	1799
Aluminum	48 × 72" (1219 × 1829 mm)	30392307	1293

Rods, Frames, & Supports

Heavy-Duty Lab-Frame

Floor mounted, free-standing unit is specifically designed for heavy-duty work such as pilot plant set-ups. Outside frame is constructed of a strong, but lightweight steel channel. Interior lattice uses a horizontal channel connector; one end accommodates the rod, the other end fits into the channel and locks tightly with a bolt. Loosen the bolt, and the connector slides easily along the channel track for simple lattice adjustment. Entire apparatus is supported on sturdy, counter-weighted cast iron feet, which may be bolted to the floor for added stability required in top-heavy installations.

Components:

- (5) 48" (1219 mm) rods
- (3) 72" (1829 mm) rods
- (15) S-Connectors
- (16) Channel Connectors
- (24) Clamping Nuts
- (2) 21.7" (551 mm) Cast Iron Feet
- (1) Frame Kit
- (1) Wrench



Material	Frame Dimensions	Overall Dimensions	Item No.	Price USD
Stainless Steel	48 x 72" (1219 x 1829 mm)	75 x 72" (1905 x 1829 mm)	30392328	3496
Aluminum	48 x 72" (1219 x 1829 mm)	75 x 72" (1905 x 1829 mm)	30392309	1869

Fume Hood Kits

Choose from four kits specifically designed to fit within laboratory fume hoods. All components are constructed of stainless steel with the exception of the Frame Connectors which are made of aluminum with a silicon finish.

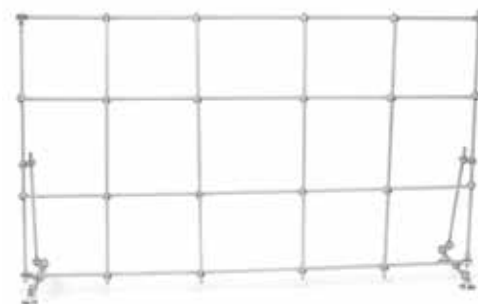

4' (1.22 m) Fume Hood Kit		5' (1.52 m) Fume Hood Kit		6' (1.83 m) Fume Hood Kit		8' (2.44 m) Fume Hood Kit	
Components: <ul style="list-style-type: none"> • (8) 2" (51 mm) rods • (2) 12" (305 mm) rods • (2) 18" (457 mm) rods • (4) 36" (914 mm) rods • (4) 38" (965 mm) rods • (30) Frame Connectors • (4) Rod End Connectors • (4) Lab-Frame Feet 		Components: <ul style="list-style-type: none"> • (8) 2" (51 mm) rods • (2) 12" (305 mm) rods • (2) 18" (457 mm) rods • (5) 36" (914 mm) rods • (4) 50" (1270 mm) rods • (34) Frame Connectors • (4) Rod End Connectors • (4) Lab-Frame Feet 		Components: <ul style="list-style-type: none"> • (8) 2" (51 mm) rods • (2) 12" (305 mm) rods • (2) 18" (457 mm) rods • (6) 36" (914 mm) rods • (4) 62" (1575 mm) rods • (38) Frame Connectors • (4) Rod End Connectors • (4) Lab-Frame Feet 		Components: <ul style="list-style-type: none"> • (10) 2" (51 mm) rods • (3) 12" (305 mm) rods • (2) 18" (457 mm) rods • (8) 36" (914 mm) rods • (4) 86" (2184 mm) rods • (45) Frame Connectors • (4) Rod End Connectors • (6) Lab-Frame Feet 	
Frame: 36 x 38" (914 x 965 mm) Base: 12" (305 mm) wide		Frame: 36 x 50" (914 x 1270 mm) Base: 12" (305 mm) wide		Frame: 36 x 62" (914 x 1575 mm) Base: 12" (305 mm) wide		Frame: 36 x 86" (914 x 2184 mm) Base: 12" (305 mm) wide	
Item No.	30392329	30392330	30392331	30392332	30392333	30392334	30392335
Price USD	1049	1137	1224	1401	1588	1775	1962

Rods, Frames, & Supports

Support Stands

Support Stands are made entirely of 303 stainless steel. They have a durable base that can accommodate vessels up to 18" (457 mm) in diameter within the "U". The base area is 17.75" (451 mm) across x 10.5" (267 mm) deep overall. The stainless steel support rod is 0.63" (16 mm) in diameter and is screwed to the support base. Two additional threaded holes in the base legs accommodate rods, enabling the stand to support two mixers. The "U" shape of the base should be turned from the mixing apparatus when the two outside rods are in use. This balances the weight, preventing the base from tipping.

Description	Item No.	Price USD
Support Stand with 23" (584 mm) Rod	30400030	314
Support Stand with 28" (711 mm) Rod	30400031	330
Support Stand with 36" (914 mm) Rod	30400032	379
Support Stand with 40" (1016 mm) Rod	30400033	400
Support Stand with 48" (1219 mm) Rod	30400034	422
Support Stand with 60" (1524 mm) Rod	30400035	466



Support Stand

Support Stand Stabilizer Knobs

Support Stand Stabilizer Knobs can be added to the two additional threaded holes in the base legs to secure the stand to a bench top.

Description	Item No.	Price USD
Support Stand Stabilizer Knobs (2 per pack)	30400044	63



Support Stand Stabilizer Knobs

Heavy-Duty Support Stands

Heavy-Duty Support Stands have a four point cast iron base with stainless steel support rod. They are designed to accommodate vessels up to 12" (30.5 cm) in diameter to sit close to the support rod. They have rubber cushions on each of the four corners. The base area is 16.5" (41.9 cm) across x 12" (30.5 cm) deep overall. They are ideal for Heavy-Duty Mixers, page 54-56.

Description	Item No.	Price USD
Heavy-Duty Support Stand with 18" (457 mm) Rod	30392334	314
Heavy-Duty Support Stand with 23" (584 mm) Rod	30392335	351
Heavy-Duty Support Stand with 28" (711 mm) Rod	30392336	371
Heavy-Duty Support Stand with 36" (914 mm) Rod	30392337	423
Heavy-Duty Support Stand with 40" (1016 mm) Rod	30392338	449
Heavy-Duty Support Stand with 48" (1219 mm) Rod	30392339	471
Heavy-Duty Support Stand with 60" (1524 mm) Rod	30392340	522



Heavy-Duty Support Stand

Replacement Support Rods

Description	Diameter	Item No.	Price USD
18" (457 mm) Stainless Steel Rod	0.63" (16 mm)	30400036	105
23" (584 mm) Stainless Steel Rod	0.63" (16 mm)	30400037	115
28" (711 mm) Stainless Steel Rod	0.63" (16 mm)	30400038	127
36" (914 mm) Stainless Steel Rod	0.63" (16 mm)	30400039	161
40" (1016 mm) Stainless Steel Rod	0.63" (16 mm)	30400040	185
48" (1219 mm) Stainless Steel Rod	0.63" (16 mm)	30400041	203
60" (1524 mm) Stainless Steel Rod	0.63" (16 mm)	30400042	224



Replacement Support Rods

Rods, Frames, & Supports

Cast Iron Support Stands

Cast iron support stand bases are constructed with black enamel finish for chemical resistance and durability. All bases feature a built-in support rod holder with locking knob that accepts a 0.51" (13 mm) diameter support rod. U-shaped base features three built-in support rod holders and accommodates vessels up to 5" (127 mm) in diameter.

NOTE: Support rods are not included.



Rectangular Base Support Stand, Cast Iron

Description	Dimensions	Item No.	Price USD
Rectangular Base (only)	4 × 6" (102 × 152 mm)	30392359	43
Rectangular Base (only)	5 × 8" (127 × 203 mm)	30392360	69
Rectangular Base (only)	6 × 9" (152 × 229 mm)	30392361	90
Rectangular Base (only)	8 × 10" (203 × 254 mm)	30392362	131

Tripod Base Support Stand, Cast Iron

Description	Overall Footprint Diameter	Item No.	Price USD
Tripod Base (only)	14.75" (375 mm)	30392363	84



U-Shaped Base Support Stand, Cast Iron

Description	Dimensions	Item No.	Price USD
U-Shaped Base (only)	7 × 7" (178 × 178 mm)	30392364	43

Aluminum Support Rods

Description	Diameter	Item No.	Price USD
12" (305 mm) Aluminum Rod	0.51" (13 mm)	30392274	17
18" (457 mm) Aluminum Rod	0.51" (13 mm)	30392275	18
24" (610 mm) Aluminum Rod	0.51" (13 mm)	30392276	23
36" (914 mm) Aluminum Rod	0.51" (13 mm)	30392277	25



Stainless Steel Support Rods

Description	Diameter	Item No.	Price USD
12" (305 mm) Stainless Steel Rod	0.51" (13 mm)	30392296	23
18" (457 mm) Stainless Steel Rod	0.51" (13 mm)	30392297	30
24" (610 mm) Stainless Steel Rod	0.51" (13 mm)	30392298	38
36" (914 mm) Stainless Steel Rod	0.51" (13 mm)	30392299	53



Rods, Frames, & Supports

Round Support Plate

Aluminum plate supports beakers, mantles and petri dishes. Fits standard lab-frames using connectors or holders, shown on pages 92-95.

Description	Distance from Rod	Item No.	Price USD
6" (152 mm)	2.6" (66 mm)	30392342	80



Support Plates

Designed to hold hotplates, stirrers, hotplate-stirrers, and other apparatus to lab-frames or ring stands. Aluminum construction offers strength and durability. Support plates include a non-skid rubber mat and a built-in holder that grips rods up to 0.75" (19 mm) in diameter.

Size	Plate Dimensions	Distance from Rod	Item No.	Price USD
Small	9.5 × 6.5" (241 × 165 mm)	1.9" (48 mm)	30392349	145
Medium	12.75 × 9" (324 × 229 mm)	1.9" (48 mm)	30392350	233
Large	15.75 × 12" (400 × 305 mm)	1.9" (48 mm)	30392351	291



Rods, Frames, & Supports

OHAUS Aluminum Lab-Lifts

- Exceptional stability and durability
- Aluminum construction
- Three convenient sizes

Aluminum Lab-Lifts provide stable height adjustment for various items in the lab such as flasks, baths, and small equipment. Top and bottom decks are constructed of anodized aluminum. Internal supports and drive screws are constructed of stainless steel. Oversized sure-grip adjustment knobs provide smooth and accurate height adjustment. Lab-Lifts accept optional Support Rod Kit which mounts to the upper deck.



Deck Size	Min. to Max. Height	Max. Load*	Item No.	Price USD
4 × 4" (102 × 102 mm)	2.5 to 5" (64 to 127 mm)	66 lbs (29.94 kg)	30400007	179
6 × 6" (152 × 152 mm)	3 to 9.75" (76 to 248 mm)	132 lbs (59.87 kg)	30400008	220
8 × 8" (203 × 203 mm)	3 to 9.75" (76 to 248 mm)	176 lbs (79.83 kg)	30400009	264
10 × 10" (254 × 254 mm)	3.5 to 13" (89 to 330 mm)	186 lbs (84.37 kg)	30400010	347

*NOTE: Maximum load rating represents static weight only. Static weight is the amount a unit can hold, not lift.

OPTIONAL ACCESSORIES

17" Support Rod Kit

Ideal for creating an adjustable support stand for mounting various items such as thermometer clamps, temperature probes, flask and column clamps. This kit allows you to mount a 17" (432 mm) threaded vertical support rod to the upper deck of a 6 × 6", 8 × 8", 10 × 10", 12 × 12" or 16 × 16" Lab-Lift by screwing the rod into the pre-drilled hole.

17" Support Rod Kit includes:

- 1 - 17" (432 mm) Stainless Steel Rod
- 1 - Jam Nut
- 1 - Flat Washer



Description	Rod Diameter	Item No.	Price USD
17" Support Rod Kit	0.51" (13 mm)	30400050	34

Rods, Frames, & Supports

OHAUS Heavy-Duty Lab-Lifts

- Stainless steel construction
- Seven convenient sizes to choose from
- Autoclavable and chemical resistant

These Heavy-Duty, Stainless Steel Lab-Lifts are ultra-stable lifting platforms with exceptional strength and durability. Constructed of stainless steel, Lab-Lifts are designed for use in extreme environments and high load applications. Equipped with oversized, sure-grip adjustment knobs that provide extra leverage for easy height adjustments. Durable construction allows lifts to be autoclaved or chemically cleaned. Ideal for use in fume hoods or bench tops and holds a variety of items such as glassware, hotplates, baths, and magnetic stirrers.



Deck Size	Min. to Max. Height	Max. Load*	Item No.	Price USD
3 x 3" (76 x 76 mm)	2.5 to 5" (64 to 127 mm)	100 lbs (45.36 kg)	30400000	193
4 x 4" (102 x 102 mm)	2.5 to 5" (64 to 127 mm)	100 lbs (45.36 kg)	30400001	234
6 x 6" (152 x 152 mm)	3 to 9.75" (76 to 248 mm)	133 lbs (60.33 kg)	30400002	241
8 x 8" (203 x 203 mm)	3 to 9.75" (76 to 248 mm)	227 lbs (102.97 kg)	30400003	324
10 x 10" (254 x 254 mm)	3.5 to 13" (89 to 330 mm)	247 lbs (112.04 kg)	30400004	352
12 x 12" (305 x 305 mm)	4 to 19.5" (102 to 495 mm)	100 lbs (45.36 kg)	30400005	926
16 x 16" (406 x 406 mm)	4 to 19.5" (102 to 495 mm)	100 lbs (45.36 kg)	30400006	1645

*NOTE: Maximum load rating represents static weight only. Static weight is the amount a unit can hold, not lift.

OPTIONAL ACCESSORIES

17" Support Rod Kit

Ideal for creating an adjustable support stand for mounting various items such as thermometer clamps, temperature probes, flask and column clamps. This kit allows you to mount a 17" (432 mm) threaded vertical support rod to the upper deck of a 6 x 6", 8 x 8", 10 x 10", 12 x 12" or 16 x 16" Lab-Lift by screwing the rod into the pre-drilled hole.

17" Support Rod Kit includes:

- 1 - 17" (432 mm) Stainless Steel Rod
- 1 - Jam Nut
- 1 - Flat Washer



Description	Rod Diameter	Item No.	Price USD
17" Support Rod Kit	0.51" (13 mm)	30400050	34

Ratchet Tool

Designed to add extra leverage to your 12 x 12" or 16 x 16" Lab-Lift. This recommended Ratchet Tool easily attaches to the actuating rod to allow easy, accurate adjustments.

Description	Item No.	Price USD
Ratchet Tool	30400049	69



Rods, Frames, & Supports

Cylinder Bench Clamps

Rugged cast aluminum clamps safely secure gas cylinders to benches, tables or other flat surfaces up to 2.5" (64 mm) thick. The 1" (25 mm) wide, 54" (1372 mm) long nylon strap features a nickel-plated, non-slip spring catch and buckle for easy adjustment around cylinders from 4 to 14" (102 to 356 mm) in diameter. Models 711 and 716 available with or without a "Secure Cylinder" safety message strap.

Model 711 Bench Clamp

This bench clamp has a large tightening handle for mounting to any flat surface up to 2.5" (64 mm) thick. A nylon pad prevents damage to the bench or table surface. Two tapered mounting screw holes are provided for permanent attachment to bench-top.



safety message strap

Description	Dimensions L x W x H (closed)	Cylinder Diameter	Item No.	Price USD
Model 711 Bench Clamp with Strap	3.25 x 5.25 x 6.5" (83 x 133 x 165 mm)	4 to 14" (102 to 356 mm)	30400020	71
Model 711 Bench Clamp with Safety Message Strap	3.25 x 5.25 x 6.5" (83 x 133 x 165 mm)	4 to 14" (102 to 356 mm)	30400021	84

Model 716 Bench Clamp

This bench clamp is similar to Model 711, but includes a sturdy safety chain for extra security. Chain measures 49" (1245 mm).



safety message strap

Description	Dimensions L x W x H (closed)	Cylinder Diameter	Item No.	Price USD
Model 716 Bench Clamp with Strap & Chain	3.25 x 5.25 x 6.5" (83 x 133 x 165 mm)	4 to 14" (102 to 356 mm)	30400026	77
Model 716 Bench Clamp with Safety Message Strap & Chain	3.25 x 5.25 x 6.5" (83 x 133 x 165 mm)	4 to 14" (102 to 356 mm)	30400027	92

Model 712 Heavy-Duty Bench Clamp

This bench clamp has two screw clamps to tighten for extra firm mounting to any flat surface up to 1.75" (45 mm) thick with a 1.25" (32 mm) overhang. Especially convenient for temporary storage situations. Rugged cast aluminum bench clamp features a 1" (25 mm) wide, 54" (1372 mm) long nylon strap with nickel-plated, non-slip spring catch buckle to hold cylinders from 4 to 14" (102 to 356 mm) in diameter. This clamp is not available with a safety message strap.



Description	Dimensions L x W x H (closed)	Cylinder Diameter	Item No.	Price USD
Model 712 Heavy-Duty Bench Clamp with Strap	3.25 x 6 x 4.5" (83 x 152 x 114 mm)	4 to 14" (102 to 356 mm)	30400022	74

Rods, Frames, & Supports

Model 715 Wall Bracket

Cylinder wall-mount brackets are constructed of cast aluminum and contoured to allow cylinders to fit firmly along the support edge. Recessed screw holes at each side of the bracket allow for easy wall mounting. Features a 1" (25 mm) wide, 54" (1372 mm) long nylon strap with nickel-plated, non-slip spring catch and buckle for fast, easy adjustment. Available with or without a "Secure Cylinder" safety message strap. For cylinders from 4 to 14" (102 to 356 mm) in diameter.



safety message strap

Description	Dimensions L x W x H	Cylinder Diameter	Item No.	Price USD
Model 715 Wall Bracket with Strap	1.88 x 8.13 x 4.63" (48 x 206 x 118 mm)	4 to 14" (102 to 356 mm)	30400024	63
Model 715 Wall Bracket with Safety Message Strap	1.88 x 8.13 x 4.63" (48 x 206 x 118 mm)	4 to 14" (102 to 356 mm)	30400025	77

Model 717 Wall Bracket

This wall bracket is similar to Model 715, but includes a sturdy safety chain for extra security. Chain measures 49" (1245 mm).



safety message strap

Description	Dimensions L x W x H	Cylinder Diameter	Item No.	Price USD
Model 717 Wall Bracket with Strap & Chain	1.88 x 8.13 x 4.63" (48 x 206 x 118 mm)	4 to 14" (102 to 356 mm)	30400028	71
Model 717 Wall Bracket with Safety Message Strap & Chain	1.88 x 8.13 x 4.63" (48 x 206 x 118 mm)	4 to 14" (102 to 356 mm)	30400029	87

Rods, Frames, & Supports

Model 701 PVC Coated Stand

The PVC coated stand has a flat bottom support so it can't "ride up" on the cylinder. Includes an adjustable 1" (25 mm) wide, 54" (1372 mm) long nylon strap with nickel-plated, non-slip spring catch and buckle for fast, easy adjustment to keep the cylinder safely in place against upper support bar. Lower support bar stops cylinder shift. The PVC coating prevents marring of the cylinder surface. This clamp is not available with a safety message strap.



Description	Dimensions L x W x H	Cylinder Diameter	Item No.	Price USD
Model 701 PVC Coated Stand	17.25 x 17.25 x 10.75" (438 x 438 x 273 mm)	7 to 10" (178 x 254 mm)	30400017	492

Model 703 Stand

This cast aluminum stand hinges open and has 4 thumbscrews to tightly grip cylinders from 8 to 9" (203 to 229 mm) in diameter.



Description	Dimensions (Dia. x H)	Cylinder Diameter	Item No.	Price USD
Model 703 Stand	18.25 x 6" (464 x 152 mm)	8 to 9" (203 x 229 mm)	30400018	376

Model 704 Adjustable Stand

Heavy-duty, cast aluminum stand with adjustable "L" brackets hold cylinders from 6 to 9.25" (152 to 235 mm) in diameter. Hinges open for installation without lifting the cylinder or disturbing connections. Prevents accidental tipping. Hinges open for easy, no-lifting installation.



Description	Dimensions (Dia. x H)	Cylinder Diameter	Item No.	Price USD
Model 704 Adjustable Stand	18.5 x 7.5" (470 x 191 mm)	6 to 9.25" (152 x 235 mm)	30400019	436

Model 713 Portable Stand

This cast iron portable cylinder stand offers a sturdy cylinder stand and a convenient cylinder dolly all-in-one. This cylinder stand is designed in two interlocking halves and can be installed without lifting the tank. Built-in rubber wheels for easy mobility. Three thumbscrews tightly grip cylinder.



Description	Dimensions (Dia. x H)	Cylinder Diameter	Item No.	Price USD
Model 713 Portable Stand	15.5 x 3" (394 x 76 mm)	7 to 9.25" (178 x 235 mm)	30400023	426

Flow Control Clamps

LabJaws flow control devices offer selection and quality. They are finely machined to deliver accurate regulation or interruption of fluid flow. Every flow control device resists corrosion and rust. Hosecocks offer easy one-hand operation. Convex bearing surfaces and rounded edges protect tubing. Pinchcocks are designed to quickly start and stop flow and provide complete closure without damaging tubing. Operated with a simple squeeze. Nickel-plated construction (unless otherwise noted).

Regular Hosecock

Adjustment screw with oversized head for accurate regulation. Built-in side lugs for foot mounting. Tubing retainer screw.

Stainless Steel

Min. to Max. Grip	Dimensions (W × H - open)	Item No.	Price USD
0 to 17 mm (0 to 0.67")	37 × 62 mm (1.46 × 2.44")	30392221	65

Nickel-Plated Zinc

Min. to Max. Grip	Dimensions (W × H - open)	Item No.	Price USD
0 to 17 mm (0 to 0.67")	37 × 62 mm (1.46 × 2.44")	30392210	26

Heavy-Duty Hosecock

Large hand wheel for ease of flow adjustment. Unique design offers unparalleled control. Works well with heavy cut nylon braided tubing.

Min. to Max. Grip	Dimensions (W × H - open)	Item No.	Price USD
0 to 29 mm (0 to 1.14")	57 × 106 mm (2.24 × 4.17")	30392310	65

Hosecock Extension Clamp

Similar to regular hosecock but with 145 mm (5.7") bottom mounted extension rod for attachment to frames and rods.

Min. to Max. Grip	Arm Length	Arm Dia.	Overall Length	Item No.	Price USD
0 to 17 mm (0 to 0.67")	145 mm (5.71")	8 mm (0.32")	175 mm (6.89")	30392212	53

Hosecock Foot

Add this option to Regular Hosecock (916062 or 916361) for bench or table mounting. Includes two mounting screws.

Diameter	Item No.	Price USD
27 mm (1.06")	30392211	8

Regular Pinchcock

For routine stop/start flow operation.

Min. to Max. Grip	Clamp Height	Item No.	Price USD
0 to 12 mm (0 to 0.47")	47 mm (1.85")	30392245	27

Variable Flow Pinchcock

For precise flow adjustment and duplication of flow rates.

Min. to Max. Grip	Clamp Height	Item No.	Price USD
0 to 13 mm (0 to 0.51")	47 mm (1.85")	30392247	33

Heavy-Duty Pinchcock

Equipped with heavy-duty spring for tough jobs. Ensures complete closure.

Min. to Max. Grip	Clamp Height	Item No.	Price USD
0 to 11 mm (0 to 0.43")	48 mm (1.89")	30392246	27



Misc. Non-Electrical Products

Inoculating Turntables

OHAUS hand-operated inoculating turntables produce almost concentric circles of bacterial colonies that are evenly distributed across petri dishes. Cast iron turntables are coated with gray baked acrylic enamel.

The 76 mm (3") high, small turntable accommodates 100 mm petri dishes. It has a tripod base to bring work approximately to eye level. It has a center disk covered with non-skid rubber lining.

The large turntable accommodates 100 mm or 150 mm petri dishes. It has a height of only 32 mm (1.26"), ideal for steadying a forearm on the work surface while plating. The large turntable contains two circular sections. The top section has a raised gripper lip as well as a recessed center disk covered with non-skid rubber lining.

Description	Dimensions (Dia. × H)	Item No.	Price USD
Small Turntable	4.49 × 3.03" (114 × 77 mm)	30400046	172
Large Turntable	5.91 × 1.26" (150 × 32 mm)	30400047	205



Slide Staining Rack

Constructed of stainless steel, the OHAUS Slide Staining Rack will resist corrosion under normal use. Adjustable to fit trays or sinks up to 533 mm (21") inside.

Description	Dimensions (L × W)	Item No.	Price USD
Slide Staining Rack	23.74 × 3.5" (603 × 89 mm)	30400048	72



Airejector

Rapid air removal evacuates 1 liter of air to 711 mm (28") of vacuum in 30 seconds. Works with compressed air sources to 60 psi. Nickel-plated construction.

Description	Length	Item No.	Price USD
Airejector	5.51" (140 mm)	30392367	115



Laboratory Instruments



Streamline your water quality analysis applications using the intuitive OHAUS Starter Series line of bench, portable, and pen meters. With the ability to handle applications from pH to Dissolved Oxygen- and everything in between- the Starter Series boasts powerful performance that goes where you go.



Instrument Selector Guide

	Starter Series Bench Meters					Starter Series Portable Meters				Starter Series Pen Meters					
	Starter 5000	Starter 3100M	Starter 3100	Starter 3100C	Starter 2100	Starter 300	Starter 300C	Starter 300D	Starter ST400D	pH meters	ORP meters	Conductivity meters	DO meters	Salinity meters	TDS meters
Measurement Range	-2.00 to 20.000 pH -30°C to 130 °C	-2.00 to 20.00 pH 0.0 µS/cm to 199.9mS/cm -5°C to 110 °C	-2.00 to 16.00 pH -5 °C to 110 °C	00.0 µS/cm to 199.9 mS/cm 0 °C to 100 °C	-2.00 to 16.00 pH 0 °C to 100 °C	0.00 to 14.00 pH 0 °C to 100 °C	0.0 µS/cm to 199.9 mS/cm 0 °C to 100 °C	0.0 to 199.9%; 200 to 400% 0 °C to 50 °C	0.0 to 200.0% 0 °C to 50 °C	0.00 to 14.00 pH*	-1000mV to 1000mV	0.0 to 199.9 µS/cm*	0.0 to 19.9 mg/L	0.0 to 80.0 ppt*	0 to 1000 mg/L*
Input	BNC	BNC Mini-Din	BNC	Mini-Din	BNC	BNC	Mini-Din	BNC	Mini-DIN						
Automatic Temperature Compensation	•	•	•	•	•	•	•	•	•	•*	•*	•*	•*	•*	•*
Manual Temperature Compensation	•	•	•		•	•		•							
Battery Power						•	•	•	•	•	•	•	•	•	•
1 Point Calibration	•	•	•	•	•	•	•	•	•	•*	•*	•*	•*	•*	•*
2 Point Calibration	•	•	•		•	•		•		•*					
≥3 Point Calibration	•	•	•			•				•*					
Memory	•	•	•	•		•	•	•	•						
Backlit LCD	•	•	•	•					•						
LCD					•	•	•	•		•	•	•	•	•	•
Touchscreen	•														
Mechanical Keys		•	•	•	•	•	•	•		•	•	•	•	•	•
USB	•	•													
RS232	•	•	•	•											
USB Host	•									•					
GLP / Time / Date	•					•									
Multi Languages	•														
IP Protection	X-IP54					X-IP54	X-IP54	X-IP54	X-IP54	X-IP67	X-IP67	X-IP67	X-IP67	X-IP67	X-IP67
Stand-alone Electrode Holder	•	•	•	•											
Quick Reference Operation Guide	•	•	•	•	•										
In-Use Cover	•	•	•	•		•	•								
Hold Function				•	•	•	•	•	•	•*	•	•	•	•	•
Auto Shut Off										•	•	•	•	•	•
Page No.	200	201	202	203	204	205	206	207	208	209	209	209	209	209	209

*on specific models

Starter 5000 pH Bench

High Performance Bench Meter for Universal pH Applications

- Starter 5000's performance is propelled by a 1000 item library, 10 sensors for calibration storage, 8 predefined and 1 self-defined buffer groups, 3 endpoint modes and meets GLP/GLM requirements.
- The color touchscreen operates similar to smartphones and tablets, and provides simple operation of advanced features such as one-touch toggling of measurement modes.
- With a standalone electrode holder, USB port, IP54 housing and in-use-cover, Starter 5000 provides the flexibility and protection that ensures smooth and enduring operation.



- Application** pH, oxidation-reduction potential (ORP) measurement
- Display** Backlit liquid crystal display (LCD), touchscreen
- Operation** AC adapter (included)
- Communication** RS232 and USB (included). GLP/GMP data output with real-time clock.
- Construction** ABS housing, standalone electrode holder, replaceable in-use cover
- Design Features** 3 endpoint modes, continuous measurement mode, up to 9 point calibration, 1,000 measurement memory



Model	Included Electrode	Measurement Range	Measurement Resolution	Item No.	Price USD
ST5000-B	N/A	-2.00 to 20.00 pH; -2000.00 to +2000.00 ; mV-30 to 130°C	0.001 pH; 0.01 mV; 0.1 °C	30129895	1236
ST5000-F	ST350			30129896	1314

Accessories	Item No.	Price USD
Holder, Stand Alone, Electrode	30058733	73
Adapter, 9 Pin-9 Pin, PC-SF40A	30059316	29
Printer, Impact, SF40A, AM	30064203	798
pH electrolyte	30059255	28
pH electrode protection	30059256	21
In-Use Cover, ST5000	30129897	22

Accessories	Item No.	Price USD
Holder, Stand Alone, Electrode	30058733	73
Adapter, 9 Pin-9 Pin, PC-SF40A	30059316	29
Printer, Impact, SF40A, AM	30064203	798
Buffer pH1.68 250 ml	30100424	18
Buffer pH4.01 250 ml	30100425	14
Buffer pH6.86 250 ml	30100426	14
Buffer pH7.00 250 ml	30100427	14
Buffer pH9.18 250 ml	30100428	14
Buffer pH10.01 250 ml	30100429	14
Buffer pH12.45 250 ml	30100440	18
Buffer Powder pH4.01;7.00;10.01	83033971	19

See page 210 for additional Starter Series Electrodes



Starter 3100M Bench

The Versatile Multi-Parameter Bench Meter

- Auto temperature compensation, auto buffer recognition, six pH buffer groups, five conductivity standards and automatic/manual endpoints ensure accurate and stable measurement.
- An adjustable electrode holder, a large backlit LCD for optimal viewing of results, and a Quick Guide with set-up and navigation info combine to make ST3100M a truly user-friendly experience.
- Documenting data is made efficient with a 99-item memory for pH and conductivity measurements. RS232 interface allows you to connect to an external device such as a printer to store or transfer data.



- Application** pH & Conductivity
- Display** Backlit liquid crystal display (LCD)
- Operation** AC adapter (included)
- Communication** RS232 Interface Kit (Included)
- Construction** ABS housing, standalone electrode holder, disposable in-use cover
- Design Features** Auto Temperature Compensation, manual and auto end points, 99-item memory for pH and conductivity measurements.

Model	Included Electrode	Measurement Range	Measurement Resolution	Item No.	Price USD
ST3100M-B	N/A	-2 - 20 pH; -1999 - 1999 mV; 0.0 μS/cm - 19.99 mS/cm; 0.1 mg/l - 199.9 g/l; 0 - 20MΩ·cm; 0 - 100 psu	0.01 pH; 1 mV; 0.01 μS/cm; 0.01 mg/L; .01 Ω·cm; 0.01 psu	30276082	750
ST3100M-F	ST310, STCON3			30276083	890
ST3100M-N	ST230, STTEMP30, STCON3			30332140	890

Accessories	Item No.	Price USD
Holder, Stand Alone, Electrode	30058733	73
Printer, Impact, SF40A, AM	30064203	798
RS232 Kit, STX SPX ST3100M	30268982	133
USB Kit, Device, STX SPX ST3100M	30268984	92
pH electrolyte	30059255	28
pH electrode protection	30059256	21
In-Use-Cover, STARTER	30058734	19

Accessories	Item No.	Price USD
Buffer pH4.01 250 ml	30100425	14
Buffer pH6.86 250 ml	30100426	14
Buffer pH7.00 250 ml	30100427	14
Buffer pH9.18 250 ml	30100428	14
Buffer pH10.01 250 ml	30100429	14
Buffer pH12.45 250 ml	30100440	18
Buffer pH1.68 250 ml	30100424	18
Buffer Powder pH4.01;7.00;10.01	83033971	19
Standard Conduct 10μs/cm 250 ml	30100441	18
Standard Conduct 84μs/cm 250 ml	30100442	18
Standard Conduct 1413μs/cm 250 ml	30100443	18
Standard Conduct 12.88mS/cm 250 ml	30100444	18

See page 210 for additional Starter Series Electrodes

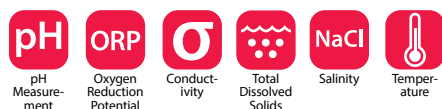

Starter 3100 pH Bench

Smart pH Bench Meter for Standard Laboratory Applications

- Starter 3100's intuitive software includes three point calibration, three buffer groups, automatic and manual endpoint functions, as well as a 99 item library.
- Among Starter 3100's user-friendly features that support ease-of-use are an adjustable standalone electrode holder and large backlit LCD display.
- Documenting measurement data is made simple through the RS232 which can be used to connect peripheral devices such as printers or computers to the meter.



- Application** pH, oxidation-reduction potential (ORP) measurement
- Display** Backlit liquid crystal display (LCD)
- Operation** AC adapter (included)
- Communication** RS232 (included)
- Construction** ABS housing, standalone electrode holder, replaceable in-use cover
- Design Features** 99 measurement memory, automatic and manual endpoint functions, automatic and manual temperature compensation, quick reference guide

Model	Included Electrode	Measurement Range	Measurement Resolution	Item No.	Price USD
ST3100-B	N/A	-2.00 to 16.00 pH ; -1999 to 1999 mV; -5 °C to 110 °C	0.01 pH; 0.1 °C; 1 mV	30057497	576
ST3100-F	ST310			30058489	656

Accessories	Item No.	Price USD
Holder, Stand Alone, Electrode	30058733	73
Adapter, 9 Pin-9 Pin, PC-SF40A	30059316	29
Printer, Impact, SF40A, AM	30064203	798
pH electrolyte	30059255	28
pH electrode protection	30059256	21
In-Use-Cover, STARTER	30058734	19

Accessories	Item No.	Price USD
Buffer pH1.68 250 ml	30100424	18
Buffer pH4.01 250 ml	30100425	14
Buffer pH6.86 250 ml	30100426	14
Buffer pH7.00 250 ml	30100427	14
Buffer pH9.18 250 ml	30100428	14
Buffer pH10.01 250 ml	30100429	14
Buffer pH12.45 250 ml	30100440	18
Buffer Powder pH4.01;7.00;10.01	83033971	19

See page 210 for additional Starter Series Electrodes



Starter 3100C Conductivity Bench

Smart Conductivity Bench Meter for Standard Laboratory Applications

- Starter 3100C's intuitive software includes four calibration points, automatic and manual endpoint functions, and one touch conversion between measurement modes.
- Among Starter 3100C's user-friendly features that support ease-of-use are an adjustable standalone electrode holder and large backlit LCD display.
- Documenting measurement data is made simple through the RS232 which can be used to connect peripheral devices such as printers or computers to the meter.



- Application** Conductivity, total dissolved solids (TDS), salinity measurement
- Display** Backlit liquid crystal display (LCD)
- Operation** AC adapter (included)
- Communication** RS232 (included)
- Construction** ABS housing, standalone electrode holder, replaceable in-use cover
- Design Features** 99 measurement memory, automatic and manual endpoint functions, automatic and manual temperature compensation

Model	Included Electrode	Measurement Range	Measurement Resolution	Item No.	Price USD
ST3100C-B	N/A	00.0 $\mu\text{S}/\text{cm}$ to 199.9 mS/cm ; 0.0 to 19.9 mg/L ;	0.01 $\mu\text{S}/\text{cm}$; 0.1 mg/L ; 0.01 psu ; 0.1 $^{\circ}\text{C}$	30058730	643
ST3100C-F	STCON3	0.00 to 19.99 psu (Salinity) ; 0 to 100 $^{\circ}\text{C}$		30058731	806

Accessories	Item No.	Price USD
Holder, Stand Alone, Electrode	30058733	73
In-Use-Cover, STARTER	30058734	19
Printer, Impact, SF40A, AM	30064203	798
Standard Conduct 10 $\mu\text{S}/\text{cm}$ 250 ml	30100441	18
Standard Conduct 84 $\mu\text{S}/\text{cm}$ 250 ml	30100442	18
Standard Conduct 1413 $\mu\text{S}/\text{cm}$ 250 ml	30100443	18
Standard Conduct 12.88 mS/cm 250 ml	30100444	18

See page 210 for additional Starter Series Electrodes



Starter 2100 pH Bench

Economical pH Bench Meter for Basic Laboratory Applications

- With the attached quick guide, five clearly marked keys and user friendly software, novices can operate the meter with minimal training.
- The built-in electrode holder provides uncomplicated and convenient all-in-one operation while the large LCD display screen clearly displays results.
- Auto buffer recognition, electrode condition icon, automatic temperature compensation and reference input all work to ensure accurate results.



- Application** pH, oxidation-reduction potential (ORP) measurement
- Display** Liquid crystal display (LCD)
- Operation** AC adapter (included)
- Construction** ABS housing, built-in electrode holder
- Design Features** Auto buffer recognition, two point calibration, quick reference guide

Model	Included Electrode	Measurement Range	Measurement Resolution	Item No.	Price USD
ST2100-B	N/A	-2.00 to 16.00 pH; -1999 to 1999 mV; 1 to 100 °C	0.01 pH; 1 mV; 0.1 °C	30057494	407
ST2100-E	ST210			30057495	433
ST2100-F	ST210; STTEMP30			30057496	476

Accessories	Item No.	Price USD
Holder, Stand Alone, Electrode	30058733	73
pH electrolyte	30059255	28
pH electrode protection	30059256	21
Buffer pH1.68 250 ml	30100424	18
Buffer pH4.01 250 ml	30100425	14
Buffer pH6.86 250 ml	30100426	14
Buffer pH7.00 250 ml	30100427	14
Buffer pH9.18 250 ml	30100428	14
Buffer pH10.01 250 ml	30100429	14
Buffer pH12.45 250 ml	30100440	18
Buffer Powder pH4.01;7.00;10.01	83033971	19

See page 210 for additional Starter Series Electrodes

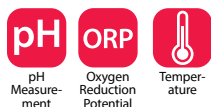

Starter 300 pH Portable

Convenient Portable pH Meter for Wherever Your Work Takes You

- Automatic and manual temperature compensation ensures accurate readings while a 30 measurement library stores data for future reference.
- The auto buffer recognition stores calibration data and helps to avoid errors during the calibration process.
- With a meter stand, wrist strap for secure field use and IP54 housing, Starter 300 is durable and prepared for versatile use.

Application pH, oxidation-reduction potential (ORP) measurement

Display Liquid crystal display (LCD)

Operation 4 AAA batteries (included)

Construction ABS housing, wrist strap

Design Features 30 measurement memory, automatic and manual endpoint functions, automatic and manual temperature compensation



ST300-G

Model	Included Electrode	Measurement Range	Measurement Resolution	Item No.	Price USD
ST300-B	N/A	0.00 to 14.00 pH; -1999 to 1999 mV; 0 to 100 °C	0.01 pH; 1 mV; 0.1 °C	83033962	277
ST300	ST320			83033961	368
ST300-G				30219114	395

Accessories	Item No.	Price USD
pH electrolyte	30059255	28
pH electrode protection	30059256	21
Portable Bag STARTER	30031635	50
Buffer pH1.68 250 ml	30100424	18
Buffer pH4.01 250 ml	30100425	14
Buffer pH6.86 250 ml	30100426	14
Buffer pH7.00 250 ml	30100427	14
Buffer pH9.18 250 ml	30100428	14
Buffer pH10.01 250 ml	30100429	14
Buffer pH12.45 250 ml	30100440	18
Seal kit, STARTER portables	83032962	38
Buffer Powder pH4.01;7.00;10.01	83033971	19

See page 210 for additional Starter Series Electrodes



Starter 300C Conductivity Portable

Convenient Portable Conductivity Meter for Wherever Your Work Takes You

- Starter 300C has a built-in temperature sensor and a 4-pole linear electrode that safeguards itself from polarization and pollution effects.
- With a simple calibration process and quick delivery of measurement results, Starter 300C is efficient and easy-to-use.
- The 30 item library allows the user to easily recall calibration data and stored information with one quick touch.

- Application** Conductivity, total dissolved solids (TDS) measurement
- Display** Liquid crystal display (LCD)
- Operation** 4 AAA batteries (included)
- Construction** ABS housing, wrist strap
- Design Features** Automatic temperature compensation, adjustable temperature coefficient



ST300C-G

Model	Included Electrode	Measurement Range	Measurement Resolution	Item No.	Price USD
ST300C-B	N/A	00.0 μ S/cm to 199.9 mS/cm ; 0.1 mg/L to 199.9 g/L (TDS); 1 to 100 °C	0.01 μ S/cm; 0.1 mg/L ; 0.1 °C;	30092000	339
ST300C	STCON3			83033964	422
ST300C- G				30219115	448

Accessories	Item No.	Price USD
Portable Bag STARTER	30031635	50
Standard Conduct 10 μ S/cm 250 ml	30100441	18
Standard Conduct 84 μ S/cm 250 ml	30100442	18
Standard Conduct 1413 μ S/cm 250 ml	30100443	18
Standard Conduct 12.88mS/cm 250 ml	30100444	18
Seal kit, STARTER portables	83032962	38
Portable Bag STARTER	30031635	50

See page 210 for additional Starter Series Electrodes

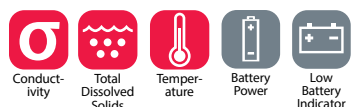

Starter 300D DO Portable

Convenient Portable Dissolved Oxygen Meter for Wherever Your Work Takes You

- The galvanic electrode can be used immediately after being powered on without the wait time typically associated with dissolved oxygen meters.
- With a simple calibration process, quick delivery of measurements and automatic temperature compensation, Starter 300D is both easy-to-use and accurate.
- 30 measurement storage endpoints allow the user to easily recall the last calibration data and stored information with one quick touch.



Application Dissolved Oxygen (DO) measurement

Display Liquid crystal display (LCD)

Operation 4 AAA batteries (included)

Construction ABS housing, wrist strap

Design Features 30 measurement memory



ST300D-G

Model	Included Electrode	Measurement Range	Measurement Resolution	Item No.	Price USD
ST300D-B	N/A	% 0.0 to 199.9%; 200 to 400%;	0.1%; 1%;	30031656	329
ST300D	STDO11 ; STTEMP30	mg/L 0.00 to 19.99; 20.0 to 45.0 mg/L	0.01 mg/L; 0.1 mg/L;	30031655	579
ST300D-G	STDO11; STTEMP30	ppm 0.00 to 19.99; 20.0 to 45.0 ppm; 0 to 50 °C	0.01 ppm; 0.1 ppm; 0.1 °C	30219116	622

Accessories	Item No.	Price USD
Portable Bag STARTER	30031635	50
Zero Oxygen Chemicals, STARTER	30059257	18
Seal kit, STARTER portables	83032962	38

See page 210 for additional Starter Series Electrodes

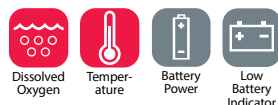

Starter 400D DO Portable

Dissolved Oxygen (DO) Meter with Optical Technology

- Optical DO Probe allows for minimal maintenance and permits for immediate measurement reading without the need for warm up time or any sample preparation.
- Large bright backlit LCD screen provides easy to read results even in low light areas, while 5 dedicated manual keys deliver simple, straightforward operation for all operators via a simple calibration process and accurate measurements.
- With a meter stand, wrist strap for secure field use and IP54 housing, Starter 400D is durable and prepared for versatile use.



Application Dissolved Oxygen measurement

Display Backlit Color Liquid Crystal Display (LCD)

Operation 4 AAA batteries (included)

Construction ABS housing, wrist strap

Design Features 99 measurement memory, last calibration data recall, auto barometric pressure measurement, auto temperature compensation with manual salinity compensation



Model	Included Electrode	Measurement Range	Measurement Resolution	Item No.	Price USD
ST400D-B	—	0.0 to 200.0%	0.1% ; 0.01 mg/L; 0.1 °C	30378541	505
ST400D-G	STDO21 (Included)	0.00 to 20.0 mg/L(ppm)		30378542	1230
ST400D		0 to 50 °C		30378543	1200

Accessories	Item No.	Price USD
Seal kit, STARTER portables	83032962	38
Zero Oxygen Chemicals, STARTER	30059257	18
DO Probe Cap, STD021	30253566	159
Portable Bag STARTER	30031635	50

See page 210 for additional Starter Series Electrodes

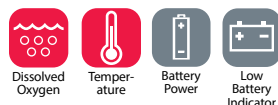

Starter Pen Meters

Accurate Electrochemistry Measurement At Your Fingertips

- Starter pen meters provide what should be expected of a small, economical pen meter: simple, fast, straightforward, no-frills operation time and time again.
- With durable ABS housing, a protective sensor cap, and automatic shutdown feature that preserves battery life, Starter pen meters can endure consistent use in rugged environments.
- Equipped with a wrist strap that prevents unintentional dropping, Starter pen meters are constructed with an IP67 waterproof design that can prevent water damage when dropped into liquid.

Application pH, oxidation-reduction potential (ORP), conductivity, total dissolved solids (TDS), salinity, dissolved oxygen (DO)

Display Liquid crystal display (LCD) display with secondary information line (on select models)

Operation 4 1.5V batteries (included)

Construction ABS Housing

Design Features Easily replaceable electrodes, automatic shut off feature



ST20D

Model	Meter Type	Measurement Range	Measurement Resolution	Temperature Display	Item No.	Price USD
ST10	pH	0.00 – 14 pH	0.1 pH	Not Available	30073970	56
ST20		0.00 – 14 pH; 0.0 – 99.0 °C	0.01 pH	Yes	30073971	99
ST10C-A	Conductivity	0.00 – 199.9 µs/cm	0.1 µs/cm	Not Available	30073972	75
ST10C-B		0 – 1999 µs/cm	1µs/cm		30073973	75
ST10C-C		0.00 – 19.99 ms/cm	10 µs/cm		30073974	75
ST20C-A		0.00 – 199.9 µs/cm; 0.0 – 99.0 °C	0.1 µs/cm	Yes	30073975	106
ST20C-B		0 – 1999 µs/cm; 0.0 – 99.0 °C	1µs/cm		30073976	106
ST20C-C		0.00 – 19.99 ms/cm; 0.0 – 99.0 °C	10 µs/cm		30073977	106
ST10T-A	TDS	0.0 – 100.0 mg/L	0.1 mg/L	Not Available	30073978	84
ST10T-B		0.0 – 1000 mg/L	1 mg/L		30073979	84
ST20T-A		0.0 – 100.0 mg/L; 0.0 – 99.0 °C	0.1 mg/L	Yes	30073980	106
ST20T-B		0.0 – 1000 mg/L; 0.0 – 99.0 °C	1 mg/L		30073981	106
ST10S	Salinity	0.0 – 10.0 ppt	0.1 ppt	Not Available	30073982	73
ST20S		0.0 – 80.0 ppt; 0.0 – 99.0 °C		Yes	30073983	106
ST10R	ORP	-1000 – 1000 mV	1 mV	Not Available	30073984	122
ST20R		-1000 – 1000 mV; 0.0 – 99.0 °C		Yes	30073985	159
ST20D	Dissolved Oxygen	0.0 – 80.0 ppt	0.1 mg/L	Yes	30073986	378

Accessories	Item No.	Price USD
Zero Oxygen Chemicals, STARTER	30059257	18
Buffer pH4.01 250 ml	30100425	14
Buffer pH7.00 250 ml	30100427	14
Buffer pH10.01	30100429	14

Accessories	Item No.	Price USD
Standard Conduct 84µs/cm 250 ml	30100442	18
Standard Conduct 1413µs/cm 250 ml	30100443	18
Standard Conduct 12.88mS/cm 250 ml	30100444	18
Membrane Kit Replaceable, ST20D	30222084	88

See page 215 for additional Laboratory Instrument Replacement Electrodes

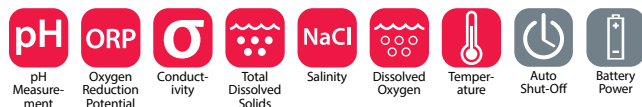

Starter Electrodes

OHAUS Precision Powers the Starter Electrodes

- Electrodes are constructed of glass or plastic and are built to withstand daily use.
- Select electrodes include a temperature sensor, which powers automatic temperature compensation and ensures accurate measurements.
- All electrodes fit perfectly in the electrode holders on OHAUS bench meters and electrode clips on all OHAUS portable meters.



Application pH, reference, oxidation-reduction potential (ORP), conductivity, dissolved oxygen (DO), temperature measurement

Construction Glass, plastic or metal

Design Features Can be used in conjunction with all Starter bench and portable meters

Model	ST5000, ST3100 & ST300	ST3100M	ST3100C & ST300C	ST300D	ST400D	Temperature	Shaft Material	Item No.	Price USD
ST230	•	•					Glass	83033968	107
ST260	•	•					Glass	30129357	143
ST270	•	•					Glass	30240974	257
ST350	•	•				•	Glass	30129354	153
STMICR05	•	•					Glass	30087566	221
STMICR08	•	•					Glass	30087569	236
STPURE	•	•					Glass	83033969	120
STREF1	•	•					Glass	30059253	128
STREF2	•	•					Glass	30059254	167
STORP2	•	•					Glass	30038553	217
STORP1	•	•					Plastic	30038555	80
ST210	•	•					Plastic	83033966	57
ST272	•	•					Plastic	30393265	150
ST310	•	•				•	Plastic	83033965	123
ST320	•	•				•	Plastic	83033967	123
STSURF	•	•					Plastic	30129470	140
STCON3		•	•			•	Plastic	83033972	263
STCON7		•	•			•	Plastic	30080693	470
STD011				•			Plastic	30031639	320
STD021, 1m					•	•	Plastic	30378544	985
STD021, 5m					•	•	Plastic	30378545	1000
STTEMP30	•	•		•		•	S.Steel	83033970	69

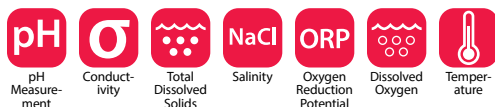

Bead Mill Homogenizer Accessories

Accessories	Item No.	Price USD
White, Bacteria, 2mL tube, 100/box	30391402	299
Yellow, Yeast, 2mL Tube, 100/box	30391404	299
Blue, Fungi, 2mL Tube, 100/box	30391405	299
Orange, Soft Sample, 2mL Tube, 100/box	30391406	299
Green, Plant, 2mL Tube, 100/box	30391408	299
Red, Animal Tissue, 2mL Tube, 100/box	30391409	299
Brown, Environmental, 2mL Tube, 100/box	30391410	306
Tube Rack, 25 x 2ml Tubes, 2 per pack	30391431	10
Sample Tube Kit, 14 Tubes	30391433	34

Centrifuge Tube Adapters

Accessories	Item No.	Price USD
Adapter, D6mm, 0.2/0.4ml Tubes x6	30130884	88
Adapter, D8mm, 0.5ml Tubes x6	30130885	88
Adapter, D11mm, 1.5/2.0ml Tubes x6	30130886	173
Adapter, D12.6mm, 1.0ml Cryo x6	30130887	275
Adapter, D12.6mm, 1.8ml Cryo x6	30130888	275
Adapter, D13.5mm, 7ml Tubes x2	30130889	104
Adapter, D13.5mm, 5ml Tubes x2	30130890	94
Adapter, D26mm, 30ml Tubes x2	30130891	218
Adapter, D18mm, 16ml Tubes x2	30130892	218
Adapter, D17mm, 15ml Tubes x2	30130893	218
Adapter, D17mm, 15ml RB Tubes x2	30130894	151
Adapter, 9x1.5/2.0ml D11mm, 2/pk	30304368	251
Adapter, 8x1.5ml D11mm, 2/pk	30304369	234
Adapter, 5x10ml D16mm RB, 2/pk	30304370	234
Adapter, 4x15ml D17mm FA, 2/pk	30304371	234
Adapter, 2x30ml D26mm RB, 2/pk	30304372	234
Adapter, 1x50ml D30mm RB, 2/pk	30304373	234
Adapter, 1x50ml D30mm FA, 2/pk	30304374	234
Adapter, 48x1.5/2.0ml D11mm, 2/pk	30314891	733
Adapter, 1x15ml D17.5mm FA, 2/pk	30314892	185
Adapter, 1x15ml D17mm RB, 2/pk	30314893	165
Adapter, 1x30ml D25mm RB, 2/pk	30314894	165
Adapter, 1x50ml D29mm RB, 2/pk	30314895	165
Adapter, 1x50ml D29mm FA, 2/pk	30314896	165
Adapter, 1x15ml D17mm FA, 2/pk	30314897	165
Adapter, 2x15ml D17mm RB, 2/pk	30314898	165
Adapter, 1x16ml D18mm RB, 2/pk	30314899	165
Adapter, 1x1.5ml for over 16000xg, 6/pk	30314900	89

Dry Block Heater Accessories

Accessories	Item No.	Price USD
Test Tube Combination	30400156	136
Centrifuge Tube Combination	30400193	136
Micro-Tube Combination	30400194	136
12 x 15mL Conical Tube	30400172	136
5 x 50mL Conical Tube	30400168	136
2 x (12) 12.5 mm Cuvettes	30400161	163
2 Block Cover	30400179	120
4 Block Cover	30400180	117
6 Block Cover	30400181	127
30 x 0.5 mL Tube	30400157	136
20 x 1.5 mL Tube	30400159	136
20 x 1.5 mL Eppendorf™ Tube	30400162	136
20 x 2 mL Eppendorf™ Tube	30400191	136
20 x 2 mL Corning™ Tube	30400192	136
2 x 96-well PCR Plate	30400171	307
10 x 8 Tube Strips	30400169	151
64 x Individual PCR Tubes	30400170	151
Solid Block, Single	30400160	136
Solid Block, Double	30400166	199
30 x 6 mm Tube	30400158	136
24 x 10 mm Tube	30400151	136
20 x 12/13 mm Tube	30400152	136
16 x 12/13 mm Tube	30400165	136
12 x 15/16 mm Tube	30400153	136
12 x 17/18 mm Tube	30400195	136
8 x 20 mm Tube	30400154	136
6 x 25 mm Tube	30400155	136
4 x 35 mm Tube	30400167	136
Sand Bath, 1 Block Dry Block Heater	30400173	294
Sand Bath, 2 Block Dry Block Heater	30400174	306
Sand Bath, 4 Block Dry Block Heater	30400175	327
Sand Bath, 6 Block Dry Block Heater	30400176	340
Sand, 1 lb (0.45 kg)	30400177	83
Stainless Steel Shot, 1 lb (0.45 kg)	30400178	101
Titer Plate	30400164	280

Dry Block Heater Accessories

Accessories	Item No.	Price USD
20 x 12 mm Vial	30400182	136
20 x 15 mm Vial	30400183	136
16 x 16 mm Vial	30400190	136
12 x 17 mm Vial	30400184	136
12 x 19 mm Vial	30400185	136
9 x 21 mm Vial	30400186	136
8 x 23 mm Vial	30400187	136
8 x 25 mm Vial	30400188	136
6 x 28 mm Vial	30400189	136

Extreme Environment and Heavy Duty Shaker Accessories

Accessories	Item No.	Price USD
18 x 18" (45.7 x 45.7 cm) Culture Platform*	30400066	337
18 x 24" (45.7 x 61 cm) Culture Platform*	30400067	352
13 x 13" (33 x 33 cm) Dedicated Platform / 125 mL Flask Clamp	30400075	528
13 x 13" (33 x 33 cm) Dedicated Platform / 250 mL Flask Clamp	30400076	528
13 x 13" (33 x 33 cm) Dedicated Platform / 500 mL Flask Clamp	30400077	528
13 x 13" (33 x 33 cm) Dedicated Platform / 1 L Flask Clamp	30400078	528
18 x 18" (45.7 x 45.7 cm) Dedicated Platform / 125 mL Flask Clamp*	30400079	585
18 x 18" (45.7 x 45.7 cm) Dedicated Platform / 250 mL Flask Clamp*	30400080	585
18 x 18" (45.7 x 45.7 cm) Dedicated Platform / 500 mL Flask Clamp*	30400081	585
18 x 18" (45.7 x 45.7 cm) Dedicated Platform / 1 L Flask Clamp	30400082	585
18" (45.7 cm) Adjustable Bar (with Mounting Hardware)	30400083	563
Two-Tier Braces (set of 4)	30400051	107

Equipment & Instrument Accessories Frontier Multi Pro Centrifuge Accessories

Accessories	Price USD	Price USD
Bucket, 100ml w/o Cap, 2/pk	30314860	282
Bucket, 100ml w/ Cap, Sealable, 2/pk	30314861	339
Screw Cap, 100ml Bucket, Sealable, 2/pk	30314862	98
O-ring, 100ml Bucket, Sealable, 10/pk	30314863	47
Bucket, 2x50ml D29mm FA, w/ Rack, 2/pk	30314881	451
Bucket, 3x15ml D17mm FA, w/ Rack, 2/pk	30314882	453
Bucket, 3xMTP, 2/pk	30314890	2781
Rack, 8x4-10ml D16mm Vac, 2/pk	30304367	272
Rack, 4x50ml D29mm FA, 2/pk	30304375	370
Rack, 10x15ml D17mm FA, 2/pk	30314583	370
Rack, 14x5-7ml D13mm Vac/Sar, 2/pk	30314584	370
Rack, 12x4-10ml D16mm Vac/Sar, 2/pk	30314585	370
Rack, 1x100ml D46mm RB, 2/pk	30314842	236
Rack, 1x85ml D38mm RB, 2/pk	30314843	236
Rack, 1x50ml D34mm RB, 2/pk	30314844	236
Rack, 1x50ml D29mm RB, 2/pk	30314845	236
Rack, 1x50ml D29mm FA, 2/pk	30314846	236
Rack, 1x50ml D29mm Rim, 2/pk	30314847	236
Rack, 1x30ml D25mm Rim, 2/pk	30314848	236
Rack, 1x25ml D25mm RB, 2/pk	30314849	236
Rack, 2x15ml D17mm FA, 2/pk	30314850	236
Rack, 1x15ml D17mm Rim, 2/pk	30314851	236
Rack, 7x15ml D17mm RB, 2/pk	30314852	236
Rack, 9x5-7ml D13mm RB, 2/pk	30314853	236
Rack, 10x1.5ml D11mm, 2/pk	30314854	236
Rack, 9x4.5ml D12mm FB, 2/pk	30314855	236
Rack, 7x5-7ml D13mm RB, 2/pk	30314856	236
Rack, 7x5-7ml D13mm Vac, 2/pk	30314857	236
Rack, 5x4-10ml D16mm Sar, 2/pk	30314858	236
Rack, 1x100ml D40mm RB, 2/pk	30314864	212
Rack, 1x85ml D38mm RB, 2/pk	30314865	212
Rack, 1x50ml D34mm RB, 2/pk	30314866	212
Rack, 1x50ml D29mm RB, 2/pk	30314867	212
Rack, 1x50ml D29mm FA, 2/pk	30314868	212
Rack, 1x50ml D29mm Rim, 2/pk	30314869	212
Rack, 1x30ml D25mm Rim, 2/pk	30314870	212
Rack, 1x25ml D25mm RB, 2/pk	30314871	212
Rack, 1x15ml D17mm FA, 2/pk	30314872	212
Rack, 2x15ml D17mm FA, 2/pk	30314873	212
Rack, 2x15ml D17mm Rim, 2/pk	30314874	212
Rack, 4x15ml D17mm RB, 2/pk	30314875	212
Rack, 7x5-7ml D13mm RB, 2/pk	30314876	212
Rack, 5x1.5ml D11mm, 2/pk	30314877	212
Rack, 3x10ml D17mm Sar, 2/pk	30314878	212
Rack, 4x5-7ml D13mm RB, 2/pk	30314879	212
Rack, 4x10ml D17mm Vac, 2/pk	30314880	212

Frontier Multi Pro Centrifuge Accessories

Accessories	Item No.	Price USD
Screw Cap, Rack of 250ml Rotor, 2/pk	30314901	112
O-ring, Rack of 250ml Rotor, 10/pk	30314902	57
Rack, 1x250ml D62mm FB, 2/pk	30314903	272
Rack, 1x100ml D41mm RB, 2/pk	30314904	272
Rack, 3x50ml D29mm RB, 2/pk	30314905	272
Rack, 3x50ml D29mm FA, 2/pk	30314906	272
Rack, 1x50ml D34mm RB, 2/pk	30314907	272
Rack, 2x50ml D29mm Rim, 2/pk	30314908	272
Rack, 1x50ml D29mm Rim, 2/pk	30314909	272
Rack, 5x25ml D24.5mm RB, 2/pk	30314910	272
Rack, 3x25ml D24.5mm Rim, 2/pk	30314911	272
Rack, 9x15ml D17mm RB, 2/pk	30314912	272
Rack, 7x15ml D17mm FA, 2/pk	30314913	272
Rack, 7x15ml D17mm Rim, 2/pk	30314914	272
Rack, 8x10ml D16mm RB, 2/pk	30314915	272
Rack, 14x5-7ml D13mm RB, 2/pk	30314916	272
Rack, 10x1.6-7ml D13mm Vac, 2/pk	30314917	272

Heavy Duty Shaker Accessories

Accessories	Item No.	Price USD
4-bar Large Vessel Carrier Platform	30400070	1227
4-bar Large Vessel Carrier Platform	30400071	1284
5-bar Large Vessel Carrier Platform	30400072	1645

Heavy Duty Vortex Mixer Accessories

Accessories	Item No.	Price USD
Foam insert for 0.5 mL microtubes	30400216	38
Foam insert for 1.5 to 2.0 mL microtubes	30400217	38
Foam insert for 12-13 mm test tubes	30400220	38
Foam insert for 15-18 mm test tubes	30400221	38
Foam insert for 19-21 mm test tubes	30400222	38
Foam insert for 22-25 mm test tubes	30400223	38
Foam insert for 26-29 mm test tubes	30400224	38

Heavy Duty Vortex Mixer Accessories

Accessories	Item No.	Price USD
Flat Foam Insert	30400209	38
Large Vessel Holder	30400211	46
Single Holder	30400219	156
Microplate Single Holder	30400215	56
Microplate Double Holder	30400213	63
Microplate Quad Holder	30400214	128
Small Vessel Holder	30400218	46
Universal Holder	30400226	58
Universal Holder Cover	30400225	20
Stackable Microplate Holder	30400212	119

Incubating Cooling Thermal Shaker Accessories

Accessories	Item No.	Price USD
24 x 2.0 mL Cryotubes	30400133	765
30 x 0.5 mL Microtubes	30400129	765
24 x 1.5 mL Microtubes	30400130	765
24 x 2.0 mL Microtubes	30400131	765
24 x 5-7 mL Tubes	30400132	765
Microplate Thermal Block with Lid	30400126	1010
384 Well Plate Thermal Block with Lid	30400127	1010
0.2 mL PCR Plate Thermal Block with Lid	30400128	1010
5 mL Eppendorf Tube Block	30400134	765
15 mL Conical Tubes	30400135	765
50 mL Conical Tubes	30400136	765

Light Duty Shaker Accessories

Accessories	Item No.	Price USD
8.6" (21.8 cm) Adjustable Bar (with Mounting Hardware)	30400122	43
18" (45.7 cm) Adjustable Bar (with Mounting Hardware)	30400073	58
2-bar Adjustable Platform	30400121	481
4-bar Adjustable Platform	30400068	512
4-bar Adjustable Platform	30400069	734
18" (45.7 cm) Adjustable Bar (with Mounting Hardware)	30400073	58
24" (61 cm) Adjustable Bar (with Mounting Hardware)	30400074	72
Dilution Cup Tray	30400125	216
Universal Harness	30400123	38

Mini Vortex Mixer Accessories

Accessories	Item No.	Price USD
Single Tube Holder	30400202	165
Cup Head	30400210	37
Cup Head	30400235	37
Micro-Tube Holder (0.5 mL)	30400204	71
Microtube Holder (1.5 mL to 2.0 mL)	30400205	71
9 to 13 mm Tube Holder (2 pack)	30400229	30
14 to 19 mm Tube Holder (2 pack)	30400230	30
20 to 25 mm Tube Holder (2 pack)	30400231	30
3" (7.6 cm) Rubber Head Cover	30400196	52
3" (7.6 cm) Head	30400236	37
3" (7.6 cm) Head with Rubber Cover	30400237	37
15 to 17 mm Ampule Tube Holder	30400207	121
10 to 17 mm Ampule Tube Holder	30400208	172
Adapter Plate For Vortex-Genie® Mixer	30400203	165
Flat Foam Insert (2 pack)	30400234	29
Insert Retainer	30400227	127
Foam Insert Variety Pack	30400201	57
Microplate Holder (2 pack)	30400233	65
Micro-Tube Holder (2 pack)	30400232	65
Micro-Tube & Microplate Holder Kit	30400198	113
Microtube Kit with /Retainer	30400200	113
Microwell Kit with Retainer	30400199	113
Rack For 30 X 0.5 mL Tube Block	30400250	38
Rack For 24X1.5 / 24X2.0 mL Tube Blocks	30400251	38
Cover For 0.5mL/1.5mL/2.0mL Tube Blocks	30400252	26
Microtube Holder	30400206	263
Vessel Harness (2 pack)	30400228	9
Tube Holder Kit	30400197	193

Multi-Tube Vortex Mixer Accessories

Accessories	Item No.	Price USD
50 x 10 mm Test Tube Foam Rack	30400238	34
50 x 12 mm Test Tube Foam Rack	30400239	33
50 x 13 mm Test Tube Foam Rack	30400240	33
50 x 16 mm Test Tube Foam Rack (for 15 mL centrifuge tubes)	30400241	44
28 x 25 mm Test Tube Foam Rack	30400243	44
15 x 29 mm Test Tube Foam Rack (for 50 mL centrifuge tubes)	30400242	44
Replacement Tray Pad Set (upper & lower)	30400245	49
Post Extension Kit	30400244	176

Equipment & Instrument Accessories Open Air and Incubating Shaker Accessories

Accessories	Platform Item No.	Price USD
11 x 13 Platform (4 Microplate Clamps)	30400052	198
13 x 13 Platform (6 Microplate Clamps)	30400053	282
18 x 18 Platform (12 Microplate Clamps)	30400054	338
18 x 24 Platform (18 Microplate Clamps)	30400056	381
18 x 30 Platform (21 Microplate Clamps)	30400057	902
24 x 24 Platform (24 Microplate Clamps)	30400058	865
24 x 36 Platform (36 Microplate Clamps)	30400059	1151
Microplate Clamp	30400104	57
Stacking Tray, 12.75 x 10" (32.4 x 25.4 cm)	30400114	152
10 mL Erlenmeyer Flask Clamp	30400084	34
25 mL Erlenmeyer Flask Clamp	30400085	34
50 mL Erlenmeyer Flask Clamp	30400086	36
125 mL Erlenmeyer Flask Clamp	30400087	36
250 mL Erlenmeyer Flask Clamp	30400088	36
500 mL Erlenmeyer Flask Clamp	30400089	39
1 L Erlenmeyer Flask Clamp	30400090	53
2 L Erlenmeyer Flask Clamp	30400091	84
2.8 L Fernbach Flask Clamp	30400092	112
3 L Fernbach Flask Clamp	30400093	151
4 L Erlenmeyer Flask Clamp	30400094	139
5 L Erlenmeyer Flask Clamp	30400095	169
11 x 13" (27.9 x 33 cm) Rubber Mat	30400060	56
13 x 13" (33 x 33 cm) Rubber Mat	30400061	68
18 x 18" (45.7 x 45.7 cm) Rubber Mat	30400062	97
18 x 24" (45.7 x 61 cm) Rubber Mat	30400063	108
24 x 24" (61 x 61 cm) Rubber Mat	30400064	127
24 x 36" (61 x 91.4 cm) Rubber Mat	30400065	141
6 L Erlenmeyer Flask Clamp	30400096	165
500 mL Media Bottle Clamp	30400097	104
1 L Media Bottle Clamp	30400098	113
125 mL Erlenmeyer Flask Clamp	30400099	38
250 mL Erlenmeyer Flask Clamp	30400100	39
500 mL Erlenmeyer Flask Clamp	30400101	45
1 L Erlenmeyer Flask Clamp	30400102	50
2 L Erlenmeyer Flask Clamp	30400103	85

Open Air and Incubating Shaker Accessories

Accessories	Item No.	Price USD
1.5 to 2 mL Micro-Tube Rack Half Size, Stationary	30400114	152
10 to 13 mm Test Tube Rack Half Size, Stationary	30400115	168
14 to 16 mm Test Tube Rack Half Size, Stationary	30400116	168
18 to 20 mm Test Tube Rack Half Size, Stationary	30400117	168
22 to 25 mm Test Tube Rack Half Size, Stationary	30400118	168
15 mL Centrifuge Tube Rack Half Size, Stationary	30400119	175
50 mL Centrifuge Tube Rack Half Size, Stationary	30400120	175
10 to 14 mm Test Tube Rack Full Size, Stationary	30400110	332
16 to 20 mm Test Tube Rack Full Size, Stationary	30400111	332
21 to 25 mm Test Tube Rack Full Size Stationary	30400112	332
50 mL Centrifuge Tube Rack Full Size, Stationary	30400113	348
13 mm Test Tube Rack Full Size, Pivoting	30400105	296
16 mm Test Tube Rack Full Size, Pivoting	30400106	296
20 mm Test Tube Rack Full Size, Pivoting	30400107	296
25 mm Tube Rack Full Size, Pivoting	30400108	296
30 mm Tube Rack Full Size, Pivoting	30400109	296
11 × 13" (27.9 × 33 cm) Universal Platform	30400052	198
13 × 13" (33 × 33 cm) Universal Platform	30400053	282
18 × 18" (45.7 × 45.7 cm) Universal Platform	30400054	338
18 × 24" (45.7 × 61 cm) Universal Platform	30400056	381
24 × 24" (61 × 61 cm) Universal Platform	30400057	902
18 × 30" (45.7 × 76.2 cm) Universal Platform	30400058	865
24 × 36" (61 × 91.4 cm) Universal Platform	30400059	1151
Two-Tier Braces (set of 4)	30400051	107

Rocking and Waving Shaker Accessories

Accessories	Item No.	Price USD
Dimpled Mat, 12.75 × 10" (32.4 × 25.4 cm)	30400140	52
Dimpled Mat, 11.75 × 8.75" (29.9 × 22.2 cm)	30400142	52
Dimpled Mat, 10 × 7.5" (25.4 × 19.1 cm)	30400141	52
Dimpled Mat, 9.25 × 7.25" (23.5 × 18.4 cm)	30400143	52
Dimpled Mat, 11.75 × 8.75" (29.9 × 22.2 cm)	30400124	49
Dimpled Mat, 14 × 11" (35.6 × 27.9 cm)	30400144	60
Stacking Tray, 12.75 × 10" (32.4 × 25.4 cm)	30400137	126
Stacking Tray, 11.75 × 8.75" (29.9 × 22.2 cm)	30400138	154
Stacking Tray, 14 × 11" (35.6 × 27.9 cm)	30400139	112

Laboratory Instrument Accessories

Accessories	Item No.	Price USD
Pen Meter Electrode pH10 ST	30087992	33
Pen Meter Electrode pH20 ST	30087993	59
Pen Meter Electrode CT10A ST	30087994	47
Pen Meter Electrode CT10B ST	30087995	47
Pen Meter Electrode CS10C ST	30087996	47
Pen Meter Electrode CT20A ST	30087997	47
Pen Meter Electrode CT20B ST	30087998	47
Pen Meter Electrode CS20C ST	30087999	47
Pen Meter Electrode R10 ST	30088020	71
Pen Meter Electrode R20 ST	30088021	94
Pen Meter Electrode ST20D	30222083	200
pH electrolyte (KCl saturated AgCl, 30ml)	30059255	28
pH electrode protection solution(3M KCl)	30059256	21
pH sensor protect bottle(10 in bag)	30064800	38
Zero Oxygen Chemicals, STARTER	30059257	18
Buffer pH1.68 250 ml	30100424	18
Buffer pH4.01 250 ml	30100425	14
Buffer pH6.86 250 ml	30100426	14
Buffer pH7.00 250 ml	30100427	14
Buffer pH9.18 250 ml	30100428	14
Buffer pH10.01 250 ml	30100429	14
Buffer pH12.45 250 ml	30100440	18
Standard Conduct 10 µs/cm 250 ml	30100441	18
Standard Conduct 84 µs/cm 250 ml	30100442	18
Standard Conduct 1413 µs/cm 250 ml	30100443	18
Standard Conduct 12.88 mS/cm 250 ml	30100444	18
Buffer Powder pH4.01; 7.00; 10.01	83033971	19

U.S. and Canada

Terms are net 30 days, FOB Worthington, Ohio USA, a service charge of 1.5% will be applied on invoice amounts past due 30 days • All orders for immediate release • No cancellations within 48 hours of acknowledged ship date • Prices, terms & specifications subject to change without prior notice • Drop shipments not available in Canada • OHAUS Corporation's products are warranted against defects in materials & workmanship from date of delivery through duration of the warranty period. During the warranty period OHAUS will repair, or, at its option, replace any component(s) that proves to be defective at no charge, provided that the product is returned, freight prepaid, to OHAUS Corporation. All other approved returns require issuance of a Return Order number from Parsippany, NJ, USA and may be subject to a 20% restocking fee. This warranty does not apply if the product has been damaged by accident or misuse, exposed to radioactive or corrosive materials, has foreign material penetrating to the inside of the product, or as a result of service or modification by other than the OHAUS Corporation or an authorized OHAUS Regional Service Center. This warranty only covers products shipped within the United States and to Canada by OHAUS Corporation to the dealer within the United States and in Canada. The warranty period for OHAUS products shall begin at the date of shipment to the end-user, or 3 months from the date of shipment to the dealer by OHAUS Corporation, whichever occurs first. A properly completed Warranty Registration Form must be received by OHAUS Corporation or product may be registered at www.ohaus.com within 30 days from the date of purchase to initiate coverage under the warranty. No other expressed or implied warranty is given by OHAUS Corporation. OHAUS Corporation shall not be liable for any consequential damages.

Outside U.S. and Canada

Payment terms: As per agreement • All prices Ex-Factory, Worthington, Ohio USA • Service charge of 1.5% will be applied on invoice amounts past due • All approved returns require issuance of a Return Order number from Parsippany, NJ, USA • Restocking fee 20% of dealer net • Minimum order: \$50.00 • All orders for immediate release • No cancellations within 48 hours of acknowledged ship date • Prices, terms & specifications subject to change without prior notice.

Business Partner Code of Conduct

OHAUS is committed to conducting its business ethically, legally and in a socially responsible manner. We expect our business partners and Dealers to share this commitment and we have therefore developed this Business Partner Code of Conduct. It covers Ethical Conduct, Fair Competition, Environment, Health and Safety, as well as Labor Practices. This code applies to all your activities in your business relationship with us. It defines the minimum standards of business conduct we expect you to comply with in your business relationship with OHAUS. You must also comply with all applicable laws, regulations, and codes of the countries in which you operate. We encourage you to work with your own business partners to ensure they also strive to meet the principles of this code, or equivalent principles. For more information and to view the whole code, please visit ohaus.com/business-partner.

Six Month Warranty			Three Year Warranty
Starter Series Electrodes			Harvard Junior® Balances
One Year Warranty			TJ611 Balance
Accessories	Hand Held Scales	SD & Catapult Scales	Five Year Warranty
Aviator® Scales	Indicators, all models	Spring Scales	All Other Mechanical Balances
CS & CL Scales	JE Emerald & JR Ruby Scales	Starter Series Meters	Ten Year Warranty
D500 Beam Scales	MB25 with MB27	TAJ Scales	Triple Beam Pro® Balances
Defender® Scales	Navigator® Scales	Valor® Scales	
CKW Scales	Primer® Balance	VX & VN Floor Scales	
ES Scales	PS Scales	Weights & Weight Sets	
FD Scales	Ranger® Scales	Y Series Scales	
Frontier Mini Centrifuge	Scale Bases, all models		
Two Year Warranty			
Adventurer® Balances	MB90 & MB120	Scout® STX , SPX & SJX Balances	
Explorer® Balances	Pioneer® & PAJ Balances	Vortex Mixers	
Hotplates & Stirrers	Dry Block Heaters	Homogenizers	
Open Air Shakers	Incubating & Incubating	Frontier Micro & Multi Centrifuges	
Labjaws Clamps & Supports	Cooling Shakers		

Any product not listed above includes a one year warranty

All replacement parts include a 90 day warranty

The following product names, features and services are trademarks owned by OHAUS® Corporation, and are protected by international copyright laws. Those trademarks followed by (®) are registered trademarks of OHAUS Corp. ; all others are trademarks of OHAUS Corp. The appropriate (®) or (™) mark should appear with its appropriate name as governed by law. Registered Trademarks: Adventurer®, Aviator®, Catapult®, Cent-O-Gram®, Defender®, Dial-O-Gram®, Explorer®, Navigator®, OHAUS®, Pioneer®, Primer®, Ranger®, Scout®, Triple Pro®, Trooper®, Valor®, Voyager®. Trademarks: AutoCal™, Caltest™, Champ™, FillGuide™, Harvard Junior™, InCal™, Maxi-Scoop™, Modular Concept™, Moveable FineRange™, ProgramLink™, QuadraStance™, ScientificStoreroom™, SmarText™, Traveler™, Weigh the Benefits™. Permission is required to reproduce the OHAUS Logo or OHAUS trademarks for use in printed materials or for electronic transmission. Please contact OHAUS Marketing Communications for permission.

OHAUS Minimum Advertised Price (MAP) Policy

OHAUS Corporation has adopted this Minimum Advertised Price (MAP) policy to protect the reputation of its brand name, better serve our customers, and in order to properly position the OHAUS brand in the marketplace. OHAUS products which are subject to this MAP policy are defined below. This Policy has been unilaterally adopted and will be enforced strictly and uniformly.

- Resellers are free to establish their own resale prices; however, they should not advertise OHAUS products below the minimum advertised prices set by OHAUS Corporation.
- Advertising includes any form of providing information about pricing that is not associated with the act of purchasing or negotiating the purchase of a product. Examples of advertising include, but are not limited to, signage, catalogs, displays, mailings, flyers, internet advertisements, internet price lists, and internet “click here” links or pop-ups and similar web-based techniques. For purposes of this policy, advertising does not include responses to email inquiries, verbal communications, or prices displayed in internet “shopping carts” or “baskets.”
- A Reseller shall not state or suggest in advertising or on a web site that a price lower than the MAP for an OHAUS product may be available during an online checkout or purchase process, including but not limited to the following: “click here for lower price,” “add to cart for discounted price,” or “price too low to advertise.” It shall not be a violation of this Policy for a Reseller to indicate that a different actual selling price is available and visible in a “shopping cart” or “basket” or as part of a sales transaction, provided these advertising restrictions are observed and no statement or suggestion of lower or discounted prices is made.
- Each Reseller shall ensure that any and all agents, service providers, and other parties it contracts with for the Reseller’s sale of OHAUS products comply with this MAP policy. Resellers shall not post OHAUS products for sale in any online or other marketplace if such a posting will result in the advertisement, by the Reseller or by the marketplace, of prices below the MAPs set by OHAUS.
- OHAUS Corporation will periodically monitor the resale market to ensure dealers are in compliance with the MAPs set by OHAUS.
- Upon verification that such dealer has advertised any of OHAUS Corporation’s products at a price less than the minimum advertised price established and announced by OHAUS Corporation from time to time (the “MAP”), OHAUS will, without assuming any liability, cancel all orders and will indefinitely refuse to accept any new orders from any reseller immediately.
- This Policy does not apply to refurbished or discontinued OHAUS products.
- It may be modified at any time by OHAUS Corporation, and the minimum advertised price may be affected by promotional periods designated by OHAUS Corporation.
- This Policy has been established unilaterally by OHAUS Corporation. No dealer’s consent or agreement to this Policy is sought, nor will such consent or agreement be accepted by OHAUS Corporation. OHAUS Corporation is providing this Policy to dealers strictly as notice of such Policy.
- The minimum advertised prices (MAPs) effective January 1, 2018 are set forth in the schedule below, exclusive of all state and local taxes.

Product Series	MAP Price % off List Price
Explorer® Series	15%
Adventurer® / Pioneer™ / PAJ Series	15%
Moisture Analyzers (MB) Series	15%
Scout® Series / SJX / TAJ Series	30%
Hand Held / CL Series/ PS Series	40%
Compact CS / Ruby Series	25%
Mechanicals (all)	25%
Starter Series Portable / Bench Meters	15%
Starter Series Pen Meters	20%
Replacement Electrodes	15%
Frontier 5306 Centrifuge	25%
Spring Scales	20%
Frontier Micro & Multi Centrifuges / Hotplates & Stirrers / Dry Block Heaters / Vortex Mixers / Open Air Shakers / Incubating & Incubating Cooling Shakers / Homogenizers / Labjaws Clamps & Supports	15%

Product Series	MAP Price % off List Price
Valor® Series	15%
FD Series	20%
Navigator® Series	20%
Defender® 7000 / 5000 / 3000 / CKW Series	20%
Emerald / YJ / YA Series	40%
ES Series	20%
SD / Catapult Series	25%
Ranger® 7000 Series	20%
Ranger / Ranger Count 3000 Series	25%
Ranger / Ranger Count 4000 Series	25%
Aviator® Series	30%
Industrial Indicators and Bases	0%
VN/VX Floor Scales	30%
Weights and Accessories	10%

OHAUS Partner Shop

The recently improved OHAUS Partner Shop is purposefully aimed at delivering a better shopping experience. We've added some great new features, making it easier to use and quicker to navigate. With advanced search capabilities, a convenient comparison function, and an order template designed to help you anticipate and quickly execute all of your ordering needs, the OHAUS Partner Shop was designed with you and your customers in mind.

Why Use OHAUS Partner Shop?

- Online Ordering
- View Product Availability and Pricing
- View Order Status
- Track Shipments
- View Invoices

How to Order

With all of these options, ordering with OHAUS has never been easier.

- Go to us.partnershop.ohaus.com to place your order and view your order history
- Email your order to sales@ohaus.com
- Fax your order to **973-944-7177**
- Call **1-800-672-7722**, and press 1 to reach a customer service representative

Having Trouble?

Contact one of our Technical Support Specialists:

- Call **1-800-672-7722**, and press 2 for technical support
- Email your question to techsupport@ohaus.com

Contact your OHAUS representative today to experience our Partner Shop!



Regional Sales Support Contact Information

Customer Service Representatives - Toll Free No **800-672-7722** ext. **7850**

Customer Service Representative	Territory by State or Province
Gina Rodriguez	NJ, PA, DE, MD, D.C., VA, Eastern NC, WV, KY, OH, IN, MI, MO, KS, Western NY, MN, IA, MO, WI, IL, Canada (ON)
Dorothea Foltzer	AR, LA, TN, MS, AL, GA, FL, SC, NC, PR, OK, TX, NM, AZ, CO, WY, MT, ID, UT, ND, SD, NE, KS, Canada (SK, MB)
Logan Kruhman	CA, NV, OR, WA, HI, AK, Canada (BC, AB), Education Market
Brian Ludlum	CT, NY, MA, ME, NH, RI, VT, Canada (QC, NS, NL), EDI Partners
Amanda Sipos	Catalog Dealers

National Sales Manager	Email	Telephone
Gary Greben	gary.greben@ohaus.com	815-355-0168

Customer Service Manager	Email	Toll free no. 800-672-7722
Debbie DeFeo	debbie.defeo@ohaus.com	ext. 7097

Dealer Support

Dealer Zone

OHAUS.com's Dealer Zone is your one-stop resource center for marketing, sales, and service support designed to help you grow your business. Featuring tips on how to effectively sell our products, e-launch kits, product information, service and support assistance, promotions, events, and much more, the OHAUS Dealer Zone serves as a fully-loaded tool allowing access to every kind of marketing support.

Why Use OHAUS Dealer Zone?

- Access an extensive array of product photos with a single click
- Download the OHAUS Magic Spreadsheet for in-depth product specifications
- Reference current and past OHAUS catalogs, brochures, and sales literature
- Download service and support documents
- Browse service and support FAQ



OHAUS Service and Product Training Seminars

Several times a year, OHAUS offers its authorized dealers a Service Training Seminar, held at our facility in Parsippany, NJ. The seminar lasts three days and covers a mix of troubleshooting, load cell repair / replacement, and common problems. The emphasis will be placed on the practical side of balance repair.

We also offer product-specific training seminars, in the form of both webinar and on-demand technical trainings on our full portfolio of weighing and laboratory equipment. These trainings offer an in-depth look at the functionality and capability of our product offerings, bettering your sales abilities.

If you are interested in finding out more about these training seminars, please contact us at TechSupport@OHAUS.com

OHAUS Document Exchange System

A comprehensive repository of sales materials, product information, and promotions, the OHAUS Document Exchange system (better known as DMX) is your one-stop shop for everything OHAUS. Register today, by visiting <http://dmx.ohaus.com/>

OHAUS On Tour Roadshow

Our fully stocked van spent 2017 driving all over the US, calling on approximately 100 dealers for product training and end-user demos. For 2018, we're making our Roadshow Van bigger and better, with technological updates as well as a more immersive, interactive product experience. Call us now to book a visit at your location, and let us bring OHAUS to you!

Applications



Features



Approvals





Laboratory Weighing



Industrial Weighing



Laboratory Equipment



Laboratory Instruments



Calibration Weights



OHAUS CORPORATION
* 7 Campus Drive
Suite 310
Parsippany, NJ 07054 USA

Tel: 800.672.7722
973.377.9000
Fax: 973.944.7177
www.ohaus.com

*With offices throughout
Europe, Asia, and
Latin America*

***ISO 9001:2008**
Registered Quality
Management System

Ingeniously Practical